

AperTO - Archivio Istituzionale Open Access dell'Università di Torino

**Analysis of Sequence Variation Underlying Tissue-specific Transcription Factor Binding and Gene Expression.**

**This is a pre print version of the following article:**

*Original Citation:*

*Availability:*

This version is available <http://hdl.handle.net/2318/133216> since 2016-07-26T20:01:46Z

*Published version:*

DOI:10.1002/humu.22343

*Terms of use:*

Open Access

Anyone can freely access the full text of works made available as "Open Access". Works made available under a Creative Commons license can be used according to the terms and conditions of said license. Use of all other works requires consent of the right holder (author or publisher) if not exempted from copyright protection by the applicable law.

(Article begins on next page)



# UNIVERSITÀ DEGLI STUDI DI TORINO

***This is an author version of the contribution published on:***

*Questa è la versione dell'autore dell'opera:*

*[Hum Mutat. 2013 Aug;34(8):1140-8. doi: 10.1002/humu.22343. Epub 2013 Jun 18.]*

.

***The definitive version is available at:***

*La versione definitiva è disponibile alla URL:*

*<http://onlinelibrary.wiley.com/doi/10.1002/humu.22343/pdf>*

Analysis of Sequence Variation Underlying Tissue-specific Transcription Factor Binding and Gene Expression

Karen M. Lower<sup>1</sup>, Marco De Gobbi<sup>1</sup>, Jim R. Hughes, Christopher J. Derry, Helena Ayyub, Jacqueline A Sloane-Stanley, Douglas Vernimmen, David Garrick, Richard J. Gibbons & Douglas R. Higgs<sup>2</sup>

MRC Molecular Haematology Unit, Weatherall Institute of Molecular Medicine, John Radcliffe Hospital, Oxford, UK.

<sup>1</sup> These authors contributed equally to this work

<sup>2</sup> To whom correspondence should be addressed. Professor Douglas R. Higgs; MRC Molecular Haematology Unit, Weatherall Institute of Molecular Medicine, John Radcliffe Hospital, Headington OX3 9DS, UK.

E-mail: [doug.higgs@imm.ox.ac.uk](mailto:doug.higgs@imm.ox.ac.uk); Phone: +44 1865 222393; Fax +44 1865 222 424

## **Abstract**

Whereas mutations causing monogenic disorders most frequently lie within the affected gene, sequence variation in complex disorders is more commonly found in non-coding regions. Furthermore, recent genome-wide studies have shown that common DNA sequence variants in non-coding regions are associated with “normal” variation in gene expression resulting in cell-specific and/or allele-specific differences. The mechanism by which such sequence variation causes changes in gene expression is largely unknown. We have addressed this by studying natural variation in the binding of key transcription factors (TFs) in the well-defined, purified cell system of erythropoiesis. We have shown that common polymorphisms frequently directly perturb the binding sites of key TFs, and detailed analysis shows how this causes considerable (~10 fold) changes in expression from a single allele in a tissue-specific manner. We also show how a single nucleotide polymorphism, located at some distance from the recognised TF binding site, may affect the recruitment of a large multiprotein complex and alter the associated chromatin modification of the variant regulatory element. This study illustrates the principles by which common sequence variation may cause changes in tissue-specific gene expression, and suggests that such variation may underlie an individual’s propensity to develop complex human genetic diseases.

## **Key Words**

Transcriptional Regulation, Transcription Factor Binding, Polymorphism, Allele-Specific



## Introduction

With few exceptions (such as X-inactivation and imprinting), all non-random differences in gene expression should ultimately be explained by a change in the DNA code. The numerous mutations that are now known to cause recognisable single gene disorders usually lie within the affected gene. Whilst some may exert their effect through creation (e.g. De Gobbi et al., 2006) or destruction (e.g. Benko et al., 2009) of a regulatory element, examples of single point mutations in regulatory elements causing human genetic disease are relatively rare. Recent genome-wide studies have shown that some common DNA sequence variants (single nucleotide polymorphisms [SNPs] and copy number variants [CNVs]) are associated with “normal” variation in gene expression (Kasowski et al., 2010; McDaniell et al., 2010). Changes in *trans*-acting factors may alter expression of both alleles of a target gene, whereas *cis*-acting variants most frequently cause changes in allele-specific expression.

In contrast to the single gene disorders, a large number of SNPs and CNVs associated with normal variation in gene expression, or associated with common complex diseases (such as diabetes, hypertension, and autoimmune disorders), often lie in non-genic regions. Whilst the mechanisms by which these sequence variants exert their effect are not well understood, they are expected to affect tissue-specific, *cis*-acting, regulatory elements. This is consistent with the observation that most normal variation in gene expression occurs in an allele-specific and tissue-specific manner (Dimas et al., 2009; Ge et al., 2009; Zhang et al., 2009). A key goal in current biology is to explain the mechanisms by which such common DNA sequence variants cause significant changes in gene expression and how this eventually relates to altered phenotypes associated with human disease. A major hurdle in analysing

such mechanisms is to identify and purify the appropriate cell type to study. Clearly a regulatory polymorphism will only affect expression when the regulatory element is active in a relevant cell type and at the appropriate stage of differentiation and development. In most cases, this information is not available and may be extremely difficult to establish.

To determine the principles by which common variants may cause allele-specific, cell-specific changes in gene expression we have studied the effects of natural DNA polymorphisms during formation of human red blood cells. Erythropoiesis provides an excellent model system in which to address such mechanisms. Purified progenitors can be obtained in large numbers and the tissue-specific regulatory elements (genome-wide) which control gene expression during erythropoiesis have been well characterised (Garrick et al., 2008; Hattangadi et al., 2011). These elements are identified by their association with DNase1 hypersensitive sites (DHS) and active chromatin marks. Furthermore, the underlying sequence contains common transcription factor (TF) binding sites including those for GATA1, Scl/TAL1 and Sp/XKLF proteins. These proteins, in turn, are thought to recruit multiprotein complexes which bind the regulatory elements and impose tissue-specific expression on their cognate genes, which are the building blocks of red blood cells.

Here we have compared the genome-wide occupancy of Scl/TAL1 in erythroid cells between two different individuals. We find that apparently non-pathological sequence variation in and around Scl/TAL1 binding sites determines whether multiprotein complexes do or do not bind particular regulatory elements. To establish the mechanism by which such polymorphisms may cause allele-specific, tissue-specific changes in gene expression, we have investigated one variant site in detail, showing how a single common polymorphism

mediates changes in the binding of many different components of a large multiprotein complex giving rise to allele- and tissue-specific expression of the gene that is regulated by this element.

## **Materials and Methods**

**Cell types.** Erythroid cells were obtained using a two-phase culture system as previously described (Pope et al., 2000). Non-erythroid cells were EBV-transformed B lymphocyte cell lines.

**ChIP and ChIP-Seq.** Chromatin immunoprecipitation was performed as previously described (De Gobbi et al., 2007). Briefly, for one immunoprecipitation,  $1 \times 10^7$  cultured primary human erythroblasts or EBV-transformed B lymphocytes were cross-linked with 1% formaldehyde for 10 minutes. DNA was sheared by sonication to fragments under 500 base pairs. Antibodies used were H3ac (06-599, Millipore), H3K4me3 (ab8580, Abcam), H3K4me1 (07-436, Millipore), RNA polymerase II (sc-9001, Santa Cruz), GATA-1 (sc-1234, Santa Cruz), and ScI/TAL1 (gifted by C. Porcher). ChIP DNA was analysed by quantitative real time PCR, calculated relative to input and normalized to a positive control. For details of primers and probe sequences see Table S1. ChIP DNA was processed for Illumina High-throughput sequencing according to Illumina protocol.

**ChIP-Seq data analysis.** Reads were aligned to the repeat masked hg18 reference genome (UCSC Genome Browser repeatmasker track) using bowtie (version 0.12.3) (Langmead et al.,

2009) with the `-m` reporting option set to 2. Replicates C1a and C1b yielded 4.7 million and 22 million, and C2a and C2b 4.1 million and 8.5 million uniquely aligned reads, respectively (Supp. Figure S1A, GEO accession number GSE42390). Since it has been shown that in ChIP-Seq studies the sensitivity of peak detection increases with the number of mapped reads (Fujiwara et al., 2009, Bernstein et al., 2012), reads from all replicates were merged. Peak detection was performed as follows using SeqMonk Software (<http://www.bioinformatics.babraham.ac.uk/projects/seqmonk/>). SeqMonk, using the “contig probe generator” option (230 bp contig of overlapping reads with a depth cutoff of 3), was used to call peaks. Peaks in C1 and C2 were then quantified by normalising the number of reads in each peak for the total number of reads detected within peaks. Of the 4538 total peaks initially identified, in order to minimize background noise only peaks containing a minimum of 32 reads in either C1b or C2b were retained. These peaks were then overlapped and annotated with the Encode generated file (<ftp://hgdownload.cse.ucsc.edu/apache/htdocs/goldenPath/hg18/encodeDCC/wgEncodeMapability/wgEncodeDukeRegionsExcluded.bed6.gz>), which contains regions in the genome which strongly overreact in high-throughput sequencing experiments due to large copy number differences between the real genome and the genome build, and therefore normalize poorly. After removal of these regions, 2936 peaks remained.

In order to identify differentially bound regions between C1 and C2, a two-classes paired-test Rank Product analysis (500 permutations, FDR<0.2) was performed (MeV4.6 TM4 Software). Whilst an FDR of 0.2 is relatively permissive, we hypothesised this was reasonable given the relatively small number of peaks analysed, and that a subset of identified differences were subject to subsequent confirmation by alternative methods (e.g. RT-PCR).

**Expression analysis.** Expression analysis was carried out as previously described (Lower et al., 2009). The mean of expression of *NME4* in Group A samples (G/G) is set to 100%, and expression in Group B samples (G/C) is expressed relative to this mean, for each tissue analysed.

**Electrophoretic mobility shift assay (EMSA).** Nuclear extracts from K562 erythroleukaemia cells were prepared, and EMSAs were carried out as described previously (Crossley et al., 1996). Double strand oligonucleotides were prepared by annealing 28 bp oligonucleotides containing either the G or the C variant of the *NME4* intronic GC-box (chr16:389546-389573, hg18 build sequence; Table S2), radiolabeled and incubated with 3-5  $\mu\text{g}$  nuclear extract protein. For antibody supershift assay, 0.4  $\mu\text{g}$  of Sp1 (sc-59, Santa Cruz), Sp3 (sc-13018, Santa Cruz), EKLF and BKLF (both gifted by M. Crossley) antibody was added before addition of the probe, and samples were incubated on ice for 2 hours. The protein/DNA interaction were resolved on a 5% non denaturing polyacrylamide gel (37.5 :1 acrylamide:bis-acrylamide, 0.25X TBE), followed by exposure to x-ray film.

**Statistical analysis.** Significance of differences in expression between Groups A and B was calculated with a 2-tailed Student's t-test assuming non-equal variance.

**Pyrosequencing.** The ratio of expression of allele-specific transcripts of *NME4* was ascertained by pyrosequencing. Primer and dispensation information has been published previously (Lower et al. 2009). Peak height is directly proportional to the amount of nucleotide incorporated. Analysis was performed in duplicate and an average obtained.

**Sequence information.** All human sequence positions correspond to the International Human Genome Sequencing Consortium Human Mar. 2006 (hg18) Assembly sequence. The *NME4* gene corresponds to sequence position chr16:387193-390755; *eNME4* corresponds to sequence position chr16:389609-390755. SNP reference numbers refer to dbSNP build 132.

## Results

### The Genome-wide Occupancy of Scl/TAL1 In Human Primary Erythroid Cells

ChIP-Seq experiments using an Scl/TAL1 antibody were carried out in primary erythroid cells cultured from two individuals of Caucasian origin (C1 and C2). Cell surface expression of the transferrin receptor (CD71) and glycophorin A (GPA) was analysed in order to ensure that all cell populations were harvested at equivalent stages of erythroid differentiation (Supp. Figure S2A). ChIP-Seq libraries were prepared from two biological replicates for each individual after validation by qPCR analysis of Scl/TAL1 binding at known targets within the  $\alpha$  and  $\beta$ -globin loci (Supp. Figure S2B).

Global analysis of these data sets (see Materials and Methods and Supp. Figure S1A) identified a total of 2936 Scl/TAL1 bound regions from both individuals that were used for further analysis. This approach identified known functional Scl/TAL1 target sequences, previously reported in human and in mouse erythroid cells (including the  $\alpha$  globin MCS-Rs,  $\beta$  globin LCR, *ALAD*, *EPB42*, *GATA1*, *GYP A*, *KIT*, *KLF1*, *LMO2*, *PRDX2*, *RUNX1*, *Scl/TAL1*, *TRIM10*) (Figure 1 and Supp. Table S3). Compared to a recently published global

map of Scl/TAL1 binding in human pro-erythroblasts (Palii et al., 2011) we identified fewer binding sites, which can be mostly accounted for by the increased stringency of our analysis. Nevertheless, these peaks showed a very high overlap (80%) with the previously published data (Palii et al., 2011) (Supp. Figure S1B), confirming that we had successfully identified *bona fide* Scl/TAL1 targets in this analysis.

To identify the specific sequences responsible for the chromatin occupancy by Scl/TAL1, we undertook MEME and DREME *de novo* motif finding analysis (Machanick and Bailey, 2011) (Supp. Figure S3). We identified the previously known predominant Scl/TAL1 binding sequence (WGATAR; GATA motif), confirming that most often Scl/TAL1 binding is directed by interactions with GATA factors. Our dataset revealed the combinatorial CTG(n9)GATA motif as the most significant composite motif (MEME output in Supp. Figure S3). In addition, other motifs were also significantly enriched at the Scl/TAL1 targets, as predicted by JASPAR CORE 2009 (Supp. Figure S3). Amongst these were binding sites for known TFs (Sp/XKLF, RUNX1, NFE2), implying that the combined action of ubiquitous and tissue-specific TFs can determine the specificity of Scl/TAL1 binding *in vivo*.

### **Scl/TAL1 Occupancy Varies Between Individuals**

Having produced a high-resolution map of Scl/TAL1 genomic targets in erythroid cells, we next investigated how many of these targets varied between these two individuals. We first ensured that the number of sequence reads within Scl/TAL1 peaks were closely

correlated between both individuals (Figure 2A). We found a very tight correlation between both individuals ( $R^2=0.89$ ) with few outliers. In order to detect differential Scl/TAL1 bound regions, we used a two-class paired-test Rank Product analysis (MeV4.6 TM4 Software). This method detects regions that are consistently different in the two sets of replicated experiments, independent of their numerical intensities. Fourteen regions were found to bind more in C1 compared to C2 (Figure 2A, red dots) and 11 regions more in C2 compared to C1 (Figure 2A, purple dots) (500 permutations, FDR=0.2). Examples of the differential binding signal in the two individuals are shown in Figure 2B-C, Supp. Figure S4A-D and Supp Figure S5-S6. Having found that 25/2936 (0.8%) of Scl/TAL1 binding regions differed significantly between these two individuals, we validated a sample of 14 differential peaks (7 from each set of differential bound regions) using standard ChIP-qPCR. All interrogated regions were validated as true differential binding sites as compared to a set of control peaks, which were found to be of similar intensity in the two individuals (Supp. Figure S4E).

We next examined the DNA sequences underlying the observed differential binding. Given that we had identified both the combinatorial CTG(n9)GATA binding site, and an enrichment of other TF binding sites within our identified Scl/TAL1 peaks (Supp. Figure S3), we chose to analyse the underlying sequence in both individuals, extending 500bp either side of the differential Scl/TAL1 peaks (Supp. Table S4). This revealed that 100% of the 14 differential binding regions validated by qPCR contained at least one putative GATA binding site (Table 1). We found that WGATAR motifs were directly disrupted by SNPs in five regions (Peaks 1-5, Table 1), most likely resulting in the observed inability to bind Scl/TAL1. In another region, the identified polymorphism created a new E-box site adjacent to a WGATAR site (Peak 6, Table 1), presumably resulting in this sequence gaining an ability to bind Scl/TAL1. SNPs were also found in relative close proximity (7-85 bp) to a GATA site



in four regions (Peaks 7-10, Table 1), whereas strikingly, in two regions, SNPs were >200 bp away from the GATA site (Peaks 11-12, Table 1). Finally, one region was deleted, as part of a >1kb deletion (Peak 13, Table 1), and in one region no sequence differences were identified within 500bp of the differential binding peak (Peak 14, Table 1). The latter case indicates that other factors (e.g. trans-acting, epigenetic or long-range interaction) may play a role in TF recruitment. In this respect, it is notable that 2 regions (Peaks 7 and 11) which were bound by Scl/TAL1 in C1 and were not bound in C2 were only 25kb apart from each other (Supp. Figure S4C).

In summary, the sequence variants underlying the different Scl/TAL1 binding showed several patterns, two of which might be expected (variation in the E-box recognised by Scl/TAL1, and variants in the GATA motif to which frequent partners of Scl/TAL1, the GATA factors, bind). Others were unexpected, such as variants in motifs that are moderately distant from the key binding site motif, or even sequences with no variants, implying alterations at a second site or epigenetic differences. These insights were studied in more depth at a locus encoding the *NME4* gene (OMIM 601818).

### ***NME4* is Bound by Scl/TAL1 and Exhibits Allele-Specific Expression**

*NME4* is a widely expressed gene (encoding a dinucleotide kinase (Milon et al., 1997) that lies 200kb downstream of the  $\alpha$  globin genes (which are exclusively expressed in erythroid cells). During evolution, *NME4* has acquired a non-conserved GATA-1 site, which forms a new element that recruits both Scl/TAL1 and GATA1 *in vivo*, resulting in the production of an alternative erythroid-specific transcript (Figure 3A) (Lower et al., 2009). We have previously shown that in erythroid cells the distal enhancer of the  $\alpha$  globin genes

physically interacts (over a distance of 300kb) with the *NME4* allele *in-cis*, and significantly up-regulates (by a factor of ~10-fold) expression of the full length *NME4* transcript compared to non-erythroid cells (Lower et al., 2009).

We analysed expression of *NME4* in a number of normal individuals. In non-erythroid cells, all individuals (Groups A and B) expressed similar levels of *NME4* (Figure 3B) consistent with the presence of two functional *NME4* genes. However, in erythroid cells, one group of individuals (Figure 3B, Group B) displayed a level of expression approximately 50% of others (Figure 3B, Group A). Pyrosequencing studies performed on a known synonymous SNP (rs14293:G>A, referred to here on as the tracking SNP), lying within both the widely expressed and erythroid-specific transcripts of *NME4*, showed that the observed reduction of the erythroid-specific expression in group B was due to specific reduction in the expression of one allele of *NME4* (the allele with A at the tracking SNP) (Figure 3C).

In view of our global survey of sequence variants affecting TF binding at GATA sites, we hypothesized that the allele-specific reduction of *NME4* may be due to the local effect of a sequence polymorphism affecting either the known GATA site or its surrounding region. We therefore sequenced 350 bp either side of the element associated with the transcription start site of *eNME4* in all individuals. Within this region we identified 7 SNPs, all of which are documented in dbSNP (Supp. Table S5). Of the 7 SNPs (6 being polymorphic in at least 3/7 individuals screened), only one (rs2071914:G>C) was found to segregate with the observed *NME4* expression pattern i.e. was homozygous (G/G) in 4 individuals with erythroid bi-allelic expression of *NME4* (Group A in Figure 3) and heterozygous (G/C) in individuals with highly-skewed erythroid expression of *NME4* (Group B in Figure 3).

Interestingly, this SNP was contained within a predicted GC-box lying 55 bp upstream of the *eNME4* transcription start site (TSS) (Figure 3A).

### **SNP rs2071914 Abrogates the Binding of TFs *in vitro***

The finding of a polymorphic GC-box in the vicinity of a canonical GATA binding site was analogous to that seen in a region identified as having differential Scl/TAL1 binding in the genome-wide analysis (Peak 7, Table 1). Therefore, we performed functional studies to explore how the GC box could be involved in recruiting a TF complex (Sp/XKLF, Scl/TAL1, GATA) at the *NME4* locus.

Given that many Sp/XKLF factors (e.g. Sp1, Sp3, BKLF and EKLF) are known to recognize and bind to GC-box elements, we hypothesized that the C variant of the SNP within the GC-box may be affecting the recognition of this site by such TFs. Therefore we carried out electrophoretic mobility shift assays (EMSAs) using double-strand oligos containing either SNP variant (Supp. Table S2). The G variant oligonucleotide was found to show a complex protein-binding pattern (Figure 4A, lane 2), which with the addition of specific antibodies was shown to include Sp1, Sp3 and BKLF (Figure 4A, lanes 3, 4 and 6). Anti-EKLF antibody did not cause a shift of this protein-DNA complex as EKLF protein is not expressed in K562 cells; this observation supports antibody specificity within this *in vitro* system (Figure 4A, lane 5). In contrast to the G oligonucleotide, the C oligonucleotide displayed no protein binding at all (Figure 4A lane 8), confirming, at least *in vitro*, that this polymorphism abrogates recognition of this sequence as a functional GC box.

## **SNP rs2071914 Perturbs Scl/TAL1 Recruitment at *eNME4***

We then went on to analyse the effect of this polymorphism on TF binding *in vivo*. We were unable to identify a C/C homozygote at this SNP, but we were able to carry out ChIP in a number of G/C heterozygotes at SNP rs2071914 (referred to here-on as the functional SNP). Due to limited sample material, and as we had already established abrogation of Sp1, Sp3 and BCLF binding at the GC-box *in vitro*, we went onto analyse the binding of tissue-specific TFs (Scl/TAL1 and GATA-1), as well as activating histone modifications (H3ac and H3K4me3), and RNA polymerase II (PolII) recruitment, by ChIP analysis in primary erythroblasts. This confirmed that individuals heterozygous for the functional SNP (C/G) displayed approximately 50% of the level of enrichment of these TFs or histone modifications (Figure 4B). This suggests that the presence of an intact GC-box can be a determinant for recruitment of functionally active tissue-specific TFs at neighbouring elements, which by themselves are not capable of any *in vivo* regulatory activity. These results give functional support that GATA and GC-box sites co-operate, and contribute towards recruiting and/or stabilizing TF binding in a tissue-specific manner.

In addition to being either homozygous or heterozygous at the functional SNP, and regardless of their level of expression of *NME4*, these individuals were all heterozygous at the tracking SNP (rs14293) (Figure 3A). PCR products containing both functional and tracking SNPs were cloned and sequenced in order to establish the phase for each SNP. In all individuals, the A allele of the tracking SNP was in phase with the C allele of the functional SNP. Due to their close proximity, the functional and tracking SNPs are likely to both be present within the same sonicated fragments of DNA (sonication was carried out to generate fragments of ~500bp). Therefore, the tracking SNP was used in a pyrosequencing

quantitative assay to determine which allele of *NME4* was enriched in chromatin fractions immunoprecipitated by antibodies recognising TFs and active histone modifications. Genomic samples of all individuals (functional SNP heterozygotes and homozygotes) were analysed to confirm heterozygosity at the tracking SNP and to determine specificity of the assay (genomic, Figure 4C). When assaying the ChIP material, individuals homozygous for the functional SNP had equal enrichment from both alleles (Figure 4C, black dots). However, individuals heterozygous for the functional SNP clearly showed skewing towards enrichment for only one allele; in all cases, enrichment came from the allele of the tracking SNP which was linked to the G variant of the functional SNP (Figure 4C, grey dots). This provides clear evidence that the C variant of the functional SNP (rs2071914) does indeed abrogate binding of these TFs *in vivo*. This results, in erythroid cells, in both the loss of *eNME4* transcription, in addition to the loss of the upregulated expression of full length *NME4*, highlighting the profound effect that SNPs which perturb Scl/TAL1 recruitment to chromatin can have on tissue-specific gene expression (Figure 5).

## **Discussion**

Using erythropoiesis as a cellular model, we have shown in detail how common sequence variation (SNPs and CNVs) can affect the binding of TF complexes at regulatory elements to produce tissue-specific and allele-specific changes in gene expression with no significant change in phenotype. Detailed analysis of erythroid elements that are commonly bound by the TFs GATA, Scl/TAL1 and SpXKLF revealed the principles by which formation of multiprotein complexes at such elements may be perturbed by common SNPs. These

common SNPs act in *cis* and directly affect, or are in close proximity to, motifs required for the recruitment of Scl/TAL1 (GATA site and E-box) or other associated TFs (GC-box). Nevertheless, in three regions identified in our genome-wide study, no DNA polymorphisms were found in close proximity (<100 bp) to GATA sites, suggesting that other factors might account for such binding differences. One possibility is that activation of such a regulatory element may depend on activation of another distal linked *cis*-acting element. This may occur when multiple, widely separated elements work together, providing different components of a multiprotein complex within the context of a transcription factory. Clearly, a regulatory SNP in one element could affect the recruitment of factors to another element, even though the sequence of the second element is unchanged. In this respect, it was of interest that 2 regions bound by Scl/TAL1 in C1 and not in C2 were only 25kb apart from each other, however the significance of this is not clear. Another possibility is that one allele has acquired an epigenetic change even though the sequence remains unaltered, as occurs at imprinted or X-inactivated loci (Jeon et al., 2012; Koerner and Barlow, 2010).

Searches for SNPs that affect binding of specific TFs naturally focus on the known consensus binding site for that factor. However, detailed analysis of the Scl/TAL1 polymorphic site at *NME4* demonstrates why this approach may be misleading. To examine the potential functional effect of SNPs lying beyond the predicted canonical binding site, we undertook detailed analysis of a locus-specific (*NME4*) regulatory SNP, which revealed how such polymorphisms can have an effect on gene expression. The erythroid specific pentameric complex (containing Scl/TAL1) would be predicted to bind to the canonical GATA sequence (WGATAR) situated at the TSS of *eNME4*. However, an upstream polymorphism within a GC-box is clearly abrogating the binding of not only the GC-box

binding TFs (SpX and xKLF) but also the erythroid specific TFs (Sci/TAL1 and GATA1) which should recognize and bind to the downstream GATA site. This upstream polymorphism clearly results in the loss of active chromatin histone modifications, PolII recruitment and transcription. This shows that the recognition of a TF binding site is clearly context dependent, and that co-operativity with proteins binding at elements in the surrounding sequence may play a crucial role for the recruitment of a specific TF. In light of the recent ENCODE data, which found that co-binding of one group of transcription factors is often affected by the binding of another transcription factor (Gerstein et al., 2012) it is likely that the situation we describe at *NME4* is a common occurrence in the genome, and functional studies such as these will be required to determine the true functional effect of this variation.

While sequence variation associated with monogenic diseases most frequently lie within the gene itself, sequence variation associated with common, complex disorders is more likely to occur in the non-coding regulatory regions of the genome. A key question to ask in this field is; what are the principles by which such variation leads to observed changes in tissue-specific, and often allele-specific, expression? The functional SNP within the GC-box at *NME4*, despite affecting the binding site of an ubiquitous TF, has no effect on gene expression in non-erythroid cells, implying that SNPs within *cis*-regulatory elements, in some cases, might be functional only in the presence of tissue-specific TFs. This finding has significance beyond *NME4*, as analysis of the ENCODE data found that one third of all DNaseI hypersensitive sites (taken as an indication of TF binding) were found in only one cell type, revealing the extent to which regulation of the genome, and hence the effect of these SNPs, varies between tissues (Neph et al., 2012).

Interestingly, despite a very large change in gene expression, we find that no apparent physiological effect results from the presence of this SNP in erythroid cells. In addition, whilst we were not able to obtain samples from individuals homozygous for the non-functional version of the SNP, such individuals do exist (as annotated in dbSNP), and to the best of our knowledge have no associated pathology. Nevertheless, this is exactly the type of variation which may be found in association with predisposition to particular common diseases. Given the exponential growth in genome-wide association studies in which numerous SNPs are being implicated in the aetiology of common complex disorders, this study elucidates molecular mechanisms that might account for phenotypic diversity and highlights the importance of carrying out functional characterisation of non-coding polymorphisms associated with disease risk in clinically relevant tissues.

### **Acknowledgements**

We thank Dr. C. Porcher for the kind gift of the Scl/TAL1 antibody; Prof. M. Crossley for the kind gift of the EKLF and BKLF antibodies; and the Computational Biology Research Group (CBRG), Oxford University, and Dr. E. Marchi for bioinformatic support. This work was supported by the Medical Research Council and the NIHR Biomedical Research Centre Programme. K.M.L. was supported by an Oxford Nuffield Medical Fellowship, Oxford University.



## References

Benko S, Fantes JA, Amiel J, Kleinjan DJ, Thomas S, Ramsay J, Jamshidi N, Essafi A, Heaney S, Gordon CT, McBride D, Golzio C et al. 2009. Highly conserved non-coding elements on either side of SOX9 associated with Pierre Robin sequence. *Nat Genet* 41:359-364

Bernstein BE, Birney E, Dunham I, Green ED, Gunter C, Snyder M. 2012. An integrated encyclopedia of DNA elements in the human genome. *Nature* 489:57-74.

Crossley M, Whitelaw E, Perkins A, Williams G, Fujiwara Y, Orkin SH. 1996. Isolation and characterization of the cDNA encoding BKLf/TEF-2, a major CACCC-box-binding protein in erythroid cells and selected other cells. *Mol Cell Biol* 16:1695-1705.

De Gobbi M, Viprakasit V, Hughes JR, Fisher C, Buckle VJ, Ayyub H, Gibbons RJ, Vernimmen D, Yoshinaga Y, de Jong P, Cheng JF, Rubin EM et al. 2006. A regulatory SNP causes a human genetic disease by creating a new transcriptional promoter. *Science* 312:1215-1217.

De Gobbi M, Anguita E, Hughes J, Sloane-Stanley JA, Sharpe JA, Koch CM, Dunham I, Gibbons RJ, Wood WG, Higgs DR. 2007. Tissue-specific histone modification and transcription factor binding in alpha globin gene expression. *Blood* 110:4503-4510.

Dimas AS, Deutsch S, Stranger BE, Montgomery SB, Borel C, Attar-Cohen H, Ingle C, Beazley C, Gutierrez Arcelus M, Sekowska M, Gagnebin M, Nisbett J et al. 2009. Common regulatory variation impacts gene expression in a cell type-dependent manner. *Science* 325:1246-1250.

Fujiwara T, O'Geen H, Keles S, Blahnik K, Linnemann AK, Kang YA, Choi K, Farnham PJ, Bresnick EH. 2009. Discovering hematopoietic mechanisms through genome-wide analysis of GATA factor chromatin occupancy. *Mol Cell* 36:667-681.

Garrick D, De Gobbi M, Lynch M, Higgs DR. 2008. Switching genes on and off in haemopoiesis. *Biochem Soc Trans* 36:613-618.

Ge B, Pokholok DK, Kwan T, Grundberg E, Morcos L, Verlaan DJ, Le J, Koka V, Lam KC, Gagne V, Dias J, Hoberman R et al. 2009. Global patterns of cis variation in human cells revealed by high-density allelic expression analysis. *Nat Genet* 41:1216-1222.

Gerstein MB, Kundaje A, Hariharan M, Landt SG, Yan KK, Cheng C, Mu XJ, Khurana E, Rozowsky J, Alexander R, Min R, Alves P et al. 2012. Architecture of the human regulatory network derived from ENCODE data. *Nature* 489:91-100.

Hattangadi SM, Wong P, Zhang L, Flygare J, Lodish HF. 2011. From stem cell to red cell: regulation of erythropoiesis at multiple levels by multiple proteins, RNAs, and chromatin modifications. *Blood* 118:6258-6268.

Jeon Y, Sarma K, Lee JT. 2012. New and Existing regulatory mechanisms of X chromosome inactivation. *Curr Opin Genet Dev* 22:62-71.

Kasowski M, Grubert F, Heffelfinger C, Hariharan M, Asabere A, Waszak SM, Habegger L, Rozowsky J, Shi M, Urban AE, Hong MY, Karczewski KJ et al. 2010. Variation in transcription factor binding among humans. *Science* 328:232-235.

Koerner MV, Barlow DP. 2010. Genomic imprinting—an epigenetic gene regulatory model. *Curr Opin Genet Dev* 20:164-170.

Langmead B, Trapnell C, Pop M, Salzberg SL. 2009. Ultrafast and memory-efficient alignment of short DNA sequences to the human genome. *Genome Biol* 10, R25.

Lower, K, Hughes J, De Gobbi M, Henderson S, Viprakasit S, Fisher C, Goriely A, Ayyub H, Sloane-Stanley J, Vernimmen D, Langford C, Garrick D et al. 2009. Adventitious changes in long-range gene expression caused by polymorphic structural variation and promoter competition. *Proc Natl Acad Sci USA* 106:21771-21776.

Machanic P, Bailey TL. 2011. MEME-ChIP: motif analysis of large DNA datasets. *Bioinformatics* 27:1696-1697.

McDaniell R, Lee BK, Song L, Liu Z, Boyle AP, Erdos MR, Scott LJ, Morken MA, Kucera KS, Battenhouse A, Keefe D, Collins FS et al. 2010. Heritable individual-specific and allele-specific chromatin signatures in humans. *Science* 328:235-239.

Milon L, Rousseau-Merck MF, Munier A, Erent M, Lascu I, Capeau J, Lacombe ML. 1997. nm23-H4, a new member of the family of human nm23/nucleoside diphosphate kinase genes localised on chromosome 16p13. *Hum Genet* 99:550-557.

Neph S, Vierstra J, Stergachis AB, Reynolds AP, Haugen E, Vernot B, Thurman, RE, John S, Sandstrom R, Johnson AK, Maurano MT, Humbert R et al. 2012. An expansive human regulatory lexicon encoded in transcription factor footprints. *Nature* 489:83-90.

Palii CG, Perez-Iratxeta C, Yao Z, Cao Y, Dai F, Davison J, Atkins H, Allan D, Dilworth FJ, Gentleman R, Tapscott SJ, Brand M et al. 2011. Differential genomic targeting of the transcription factor TAL1 in alternate haematopoietic lineages. *Embo J* 30:494-509.

Pope SH, Fibach E, Sun J, Chin K, Rodgers GP. 2000. Two-phase liquid culture system models normal human adult erythropoiesis at the molecular level. *Eur J Haematol* 64:292-303.

Zhang K, Li JB, Gao Y, Egli D, Xie B, Deng J, Li Z, Lee JH, Aach J, Leproust EM, Eggan K, Church GM et al. 2009. Digital RNA allelotyping reveals tissue-specific and allele-specific gene expression in human. *Nat Methods* 6:613-618.

## Figure Legends

**Figure 1.** Detection of Scl/TAL1 binding sites in primary human erythroblasts.

Four examples of Scl/TAL1 ChIP-Seq peaks are shown. Shown for each locus are (from top to bottom): hg 18 genomic coordinate; RefSeq gene annotation; ChIP-Seq profile in C1 and C2. The sequencing reads are visualized as peaks and mapped along the specific sequence in GBrowse. Within each track, the peak height reflects the number of mapped reads.

**Figure 2.** Differential Scl/TAL1 binding sites in C1 and C2.

**A.** Correlation plot showing the number of reads per peak of all Scl/TAL1 bound regions identified in C1 and C2. Linear regression and  $R^2$  correlation index are shown. In the right panel, which focuses on the data within the dashed lines, the differential bound regions, identified by non-parametric rank product statistical analysis, are highlighted in red (C1>C2) and in purple (C2>C1)

**B-C.** Examples of Scl/TAL1 differential peaks. The loci are annotated as in Fig. 1A. Differential peaks are indicated with an arrow.

**Figure 3.** Variable expression of *NME4* in normal individuals.

**A.** Schematic representation of the genomic structure of *NME4* and *eNME4*. Black boxes, exons; gray box, alternative erythroid-specific exon; full lines, introns; dashed lines, splicing of mature transcript; light gray lines, expanded region. The DNA sequence surrounding the transcription start of *eNME4* is shown. The predicted GC-box is in blue, and contains the functional G/C SNP (rs2071914:G>C, indicated by a vertical arrow). The GATA site underlying the *eNME4* transcription start site (TSS) is shown in red. The tracking A/G SNP

(rs14293:G>A, indicated by a vertical arrow) is also shown. The horizontal arrow represents the TSS of the erythroid-specific transcript. The red box represents the position of amplicon 389776 (referred to in Figure 4).

**B.** Expression of *NME4* in erythroid and non-erythroid cells. Expression is normalised to *CD71* (erythroid) and to 18S (non-erythroid), and expressed relative to the mean expression of group A (see text). Error bars are +/- 1 SD. Group A, n=4, black bars. Group B, n=3, green bars

**C.** Allele-specific expression of *NME4*, as determined by pyrosequencing (see Materials and Methods for details) in non-erythroid (EBV) and erythroid cDNA. All samples are heterozygous (A/G) for SNP rs14293, except for A/A and G/G genomic DNA controls (indicated by \*). Individuals in Group A (n=4; black dots) were found to be homozygous (G/G) and individuals in Group B (n=3; green dots) were found to be heterozygous (G/C) for SNP rs2071914.

**Figure 4.** The C variant of SNP2071914 abolishes binding of TFs *in vitro* and *in vivo*.

**A.** Electrophoretic mobility shift / super-shift assay. The 28bp double stranded oligonucleotides containing the native surrounding *NME4* sequence, differ only at the SNP rs2071914 (Table S2). Protein-DNA complexes were observed with the G allele upon addition of nuclear extract (lane 2), and specific complexes could be super-shifted with the addition of anti-Sp1 (lane 3), anti-Sp3 (lane 4) and anti-BKLF (lane 6) antibodies as indicated. There is no super-shift upon addition of anti-EKLF antibody as EKLF is not expressed in K562 cells (lane 5). Protein binding was completely abolished on the C allele oligonucleotide (lane 8). Addition of K562 nuclear extract is indicated by +.

**B.** Transcription factor binding, chromatin modifications and PolII at *eNME4*. Real-time analysis of ChIP enrichment at HS-40,  $\alpha$ -globin promoters, *eNME4* and a negative control *DECR2*. Enrichment is relative to input and normalized to amplicons 162909 (H3ac, H3K4me3 and PolII) or 103432 (Scl/TAL1 and GATA1). Values represent the mean of 3 (G/G) or 4 (G/C) independent experiments +/- 1SD.

**C.** Proportion of the G allele (rs2071914) of *NME4* contributing to total ChIP enrichment, determined by pyrosequencing (see Materials and Methods for details). All samples are heterozygous (A/G) for the tracking SNP rs14293, except for an A/A and a G/G genomic control (indicated by \*). Samples are grouped according to homozygosity (G/G, black dots; n=3) or heterozygosity (G/C, grey dots; n=4) for the functional SNP rs2071914. Note that the A allele of the tracking SNP was always found in phase with the C allele of the functional SNP (see text).

**Figure 5.** Schematic representation of the tissue-specific regulation of expression of *eNME4*.

**A.** When a G is present at SNP2071914, the functional GC box is able to bind the xKLF/SP1/3 factors, the downstream GATA1 site is able to bind the erythroid specific transcription factors Scl/TAL1, the associated chromatin acquires activating modifications (such as H3K4me3 and H3ac), and *eNME4* is transcribed.

**B.** When a C is present at SNP2071914, the GC box is no longer functional, which in turn abrogates the functionality of the downstream GATA1 site. The erythroid-specific transcription factors do not bind, the activating chromatin modifications are lost, and *eNME4* transcription does not occur.

SNP2071914 is underlined, with the C (non-functional) variant shown in red; the GC-box is highlighted in orange; the GATA1 site is highlighted in green; acetylated histones are shown in orange; unmodified histones are shown in green.



**Supp. Figure S1.** Experimental validation of Scl/TAL1 ChIP.

**A.** Outline of experimental design. See methods for details.

**B.** Venn diagram showing the overlap between the Scl/TAL1 binding sites detected by ChIP-Seq in this study and those identified in another Scl/TAL1 genome-wide binding analysis (Palii et al., 2011).

**Supp. Figure S2.** Characterization of erythroid cultures from C1 and C2.

**A.** Flow cytometry profile (CD71, x-axis, and GPA, y-axis) of C1 and C2 erythroblast cultures shows homogeneity of the maturation stage across the two cultures. The whole-cell culture was used for ChIP assays.

**B.** ChIP-qPCR validation at selected regions at the  $\alpha$  and  $\beta$  globin loci. The y-axis represents the enrichment over input DNA, normalized to the HS-40 positive control sequence.

**Supp. Figure S3.** DNA motifs underlying Scl/TAL1 occupancy. For each Scl/TAL1 bound region, we extracted the peak sequence and used it for searching *de novo* motifs with the MEME/DREME software (<http://meme.ebi.edu.au/meme>). MEME is able to find relatively long composite motifs, whereas DREME is a motif discovery algorithm specifically designed to find short DNA-binding motifs. Logos identified by MEME/DREME motif search are shown together with the recognizing TF, as predicted by JASPAR CORE 2009, the corresponding p-values and the number (n) of the Scl/TAL1 peaks harbouring each motif one or more time.

**Supp. Figure S4.** Examples of differential Scl/TAL1 binding.

**A-D.** The loci are annotated as in Figure 1A. Differential peaks are indicated by a vertical arrow.

**E.** qPCR validation of a subset of Scl/TAL1 differentially bound regions. For each region, the ratio between the fold enrichment, as measured by comparison with HS-40 at  $\alpha$ -globin locus, observed in C1 and in C2 is plotted on a log<sub>2</sub> scale. Del = region deleted in C1, C1/C2 ratio not calculated. Primer sequences can be found in Table S1.

**Supp. Figure S5.** Examples of differential Scl/TAL1 binding patterns in the two sets of replicates (C1>C2).

The locus is annotated as in Figure 1A. Differential peaks are indicated by a vertical arrow.

**Supp. Figure S6.** Examples of differential Scl/TAL1 binding patterns in the two sets of replicates (C2>C1).

The locus is annotated as in Figure 1A. Differential peaks are indicated by a vertical arrow.

Figure 1.

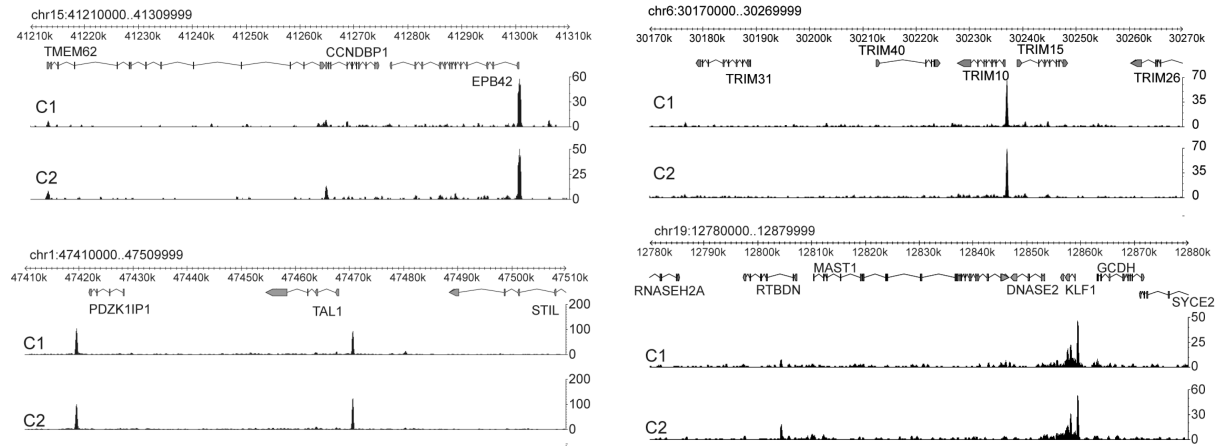
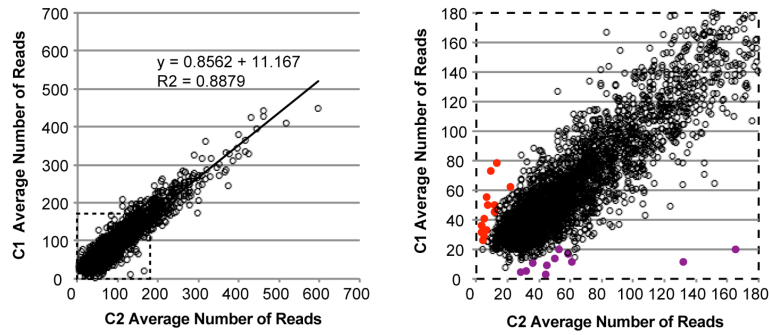
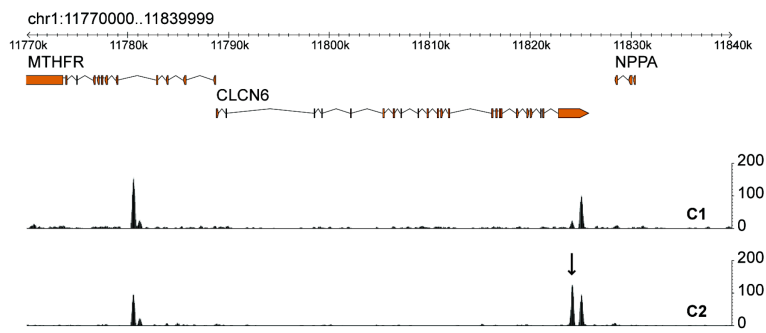

Figure 2.

A



B



C

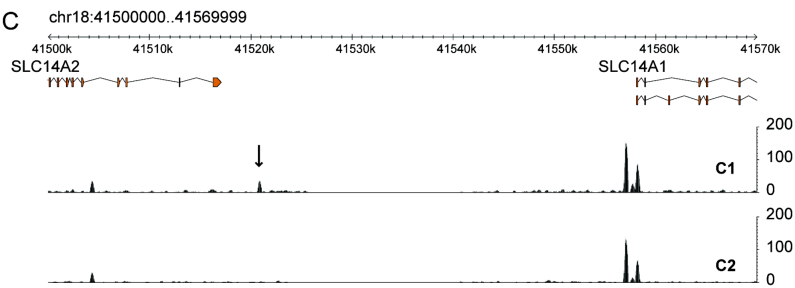

Figure 3

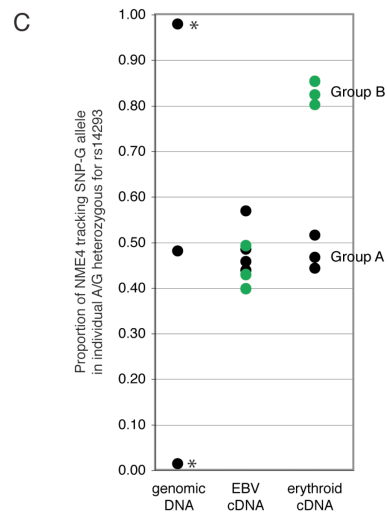
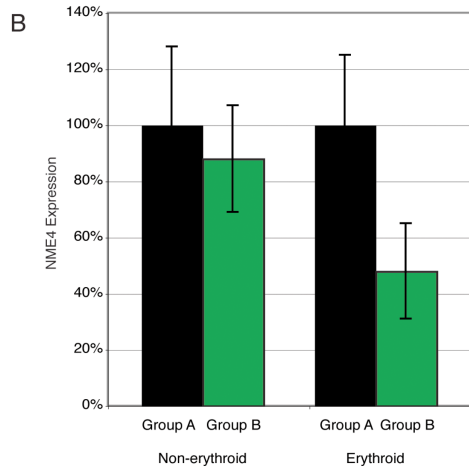
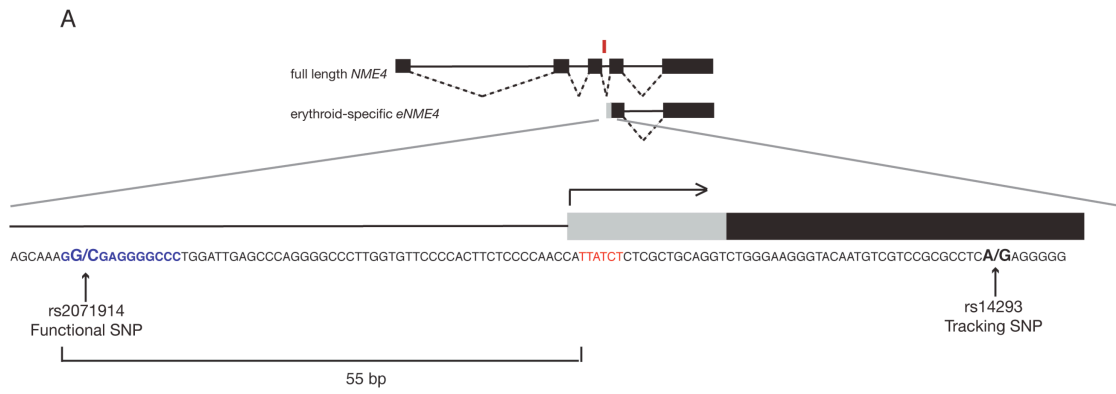

Figure 4

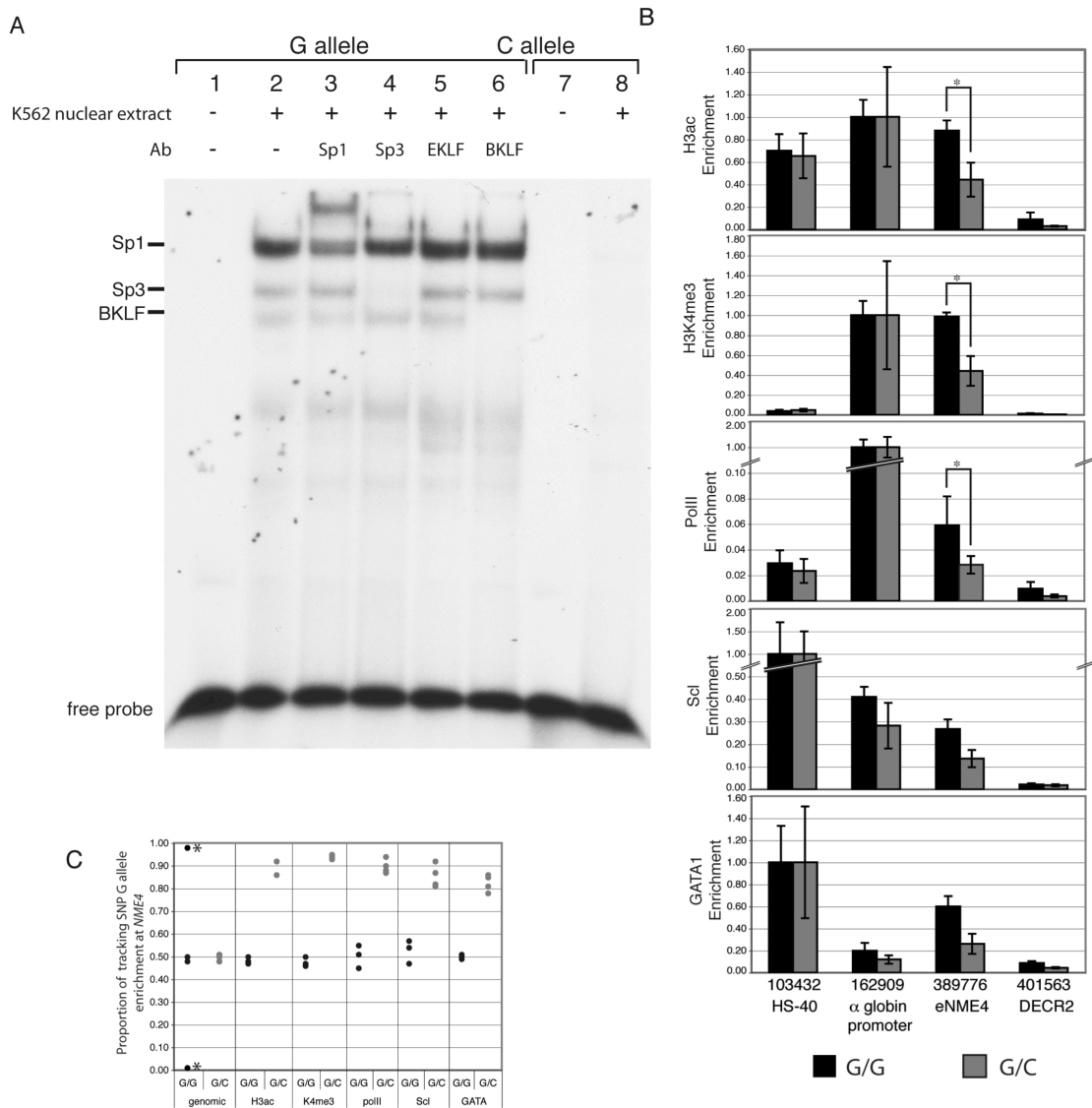
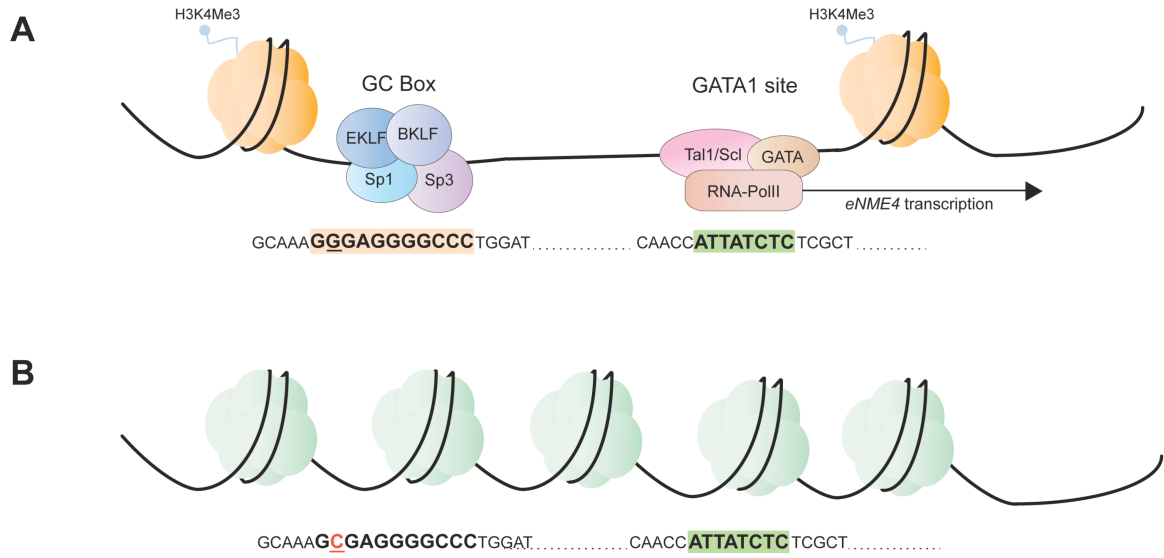

Figure 5



**Table 1.** Sequence and position of the sequence changes affecting Scl/TAL1 recruitment. For each of the 14 differentially bound regions, which were validated by qPCR, are shown: the genomic coordinate of the peak (hg18); the core sequence containing the GATA binding site and any polymorphisms identified in C1 and C2, as annotated in dbSNP. Consensus TF binding sites are highlighted in colour (GATA, red; E-box, blue; GC-box, green). Genetic variants bound by Scl/TAL1, as determined by aligning ChIP-Seq reads to the hg18 reference sequence, are underlined.

	Peak Number	Peak Coordinates	Core Sequence	dbSNPs
GATA site	1	chr12:8125196-8125527	GTGGTTAAGTTTA <sup>C</sup> <u>T</u> CTTTGGGGCGCAG	rs3759283
	2	chr19:19389656-19389955	GAC <sup>A</sup> / <sub>G</sub> TCTGGGGCACTCAG <sup>C</sup> / <u>Δ</u> TAA	rs1469713; rs1469712
	3	chr1:11823982-11824390	TGCTTATCTTCCCCACCTTCTACATGGTAT <sup>T</sup> / <u>C</u> AGTCC	rs198415
	4	chr16:73494579-73494881	TT <sup>C</sup> / <u>Δ</u> TCTGCCAAC <sup>T</sup> / <u>Δ</u> TTCT-n35-TGATAACTA	rs9937638; rs7194514
	5	chr6:157802553-157802848	CAATGTGGTGATA <sup>C</sup> / <u>Δ</u> CCTCTCCA	rs2180414
E-box	6	chr2:119649638-119649869	C <sup>G</sup> / <u>Δ</u> GCTGCA-n30-CATAGATATCGT	rs112342010
Adjacent to GATA site (<100 bp)	7	chr13:41468093-41468389	CA <sup>A</sup> / <sub>G</sub> AC-n33-AAGATAA -n15-AC <sup>G</sup> / <u>Δ</u> ATAA-n52-GGC <sup>A</sup> / <u>G</u>	rs11619622; rs11617432; rs9566899
	8	chr15:91799869-91800133	ACACA <sup>A</sup> / <sub>G</sub> CCCTTCTTATCTGCAC	rs11330687
	9	chr15:96337475-96337870	GAGATATGAATAGTCAACTAA <sup>A</sup> / <sub>G</sub> TCAG	rs28508084
	10	chr2:23603139-236034378	TG <sup>G</sup> / <u>Δ</u> GAATTACATGCTATCTAGGGA	rs1356334
Far from GATA site (>200bp)	11	chr13:41494029-41494354	TCA <sup>T</sup> / <sub>C</sub> A-n200-TTATCA-n20-TTATCT-n260-CCC <sup>G</sup> / <u>Δ</u> ATAA	rs9532971; rs73185392
	12	chr6:6424981-64225350	CGGCTA <sup>C</sup> / <u>Δ</u> AGTT-n215-ACGATATAAT	rs12205172
Deletion	13	chr22:22718160-22718399	AGGCATATCACGTTCT	
No differences	14	chr7:102968785-102969074	CAGCTGGCAG-n20-CAACCAGCTGG-n25-GTATCTTT	



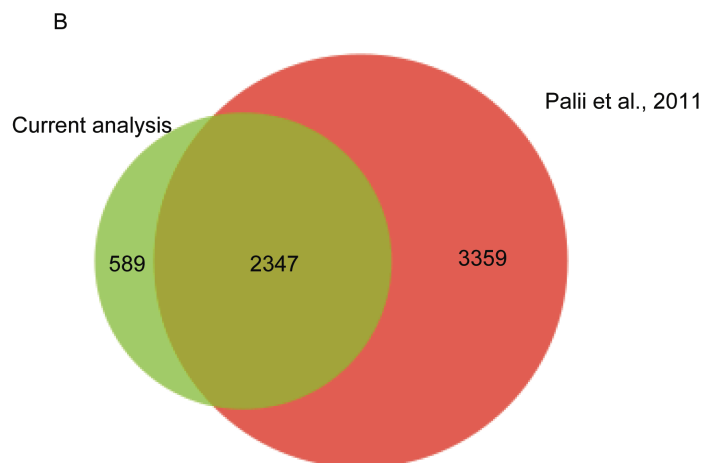
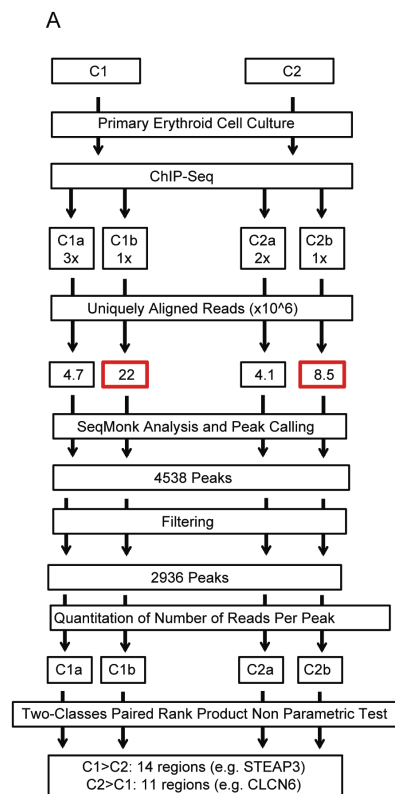

**Supp. Figure S1.** Experimental validation of Scl/TAL1 ChIP.

**A.** Outline of experimental design. See methods for details.

**B.** Venn diagram showing the overlap between the Scl/TAL1 binding sites detected by ChIP-Seq in this study and those identified in another Scl/TAL1 genome-wide binding analysis (Palii et al., 2011).

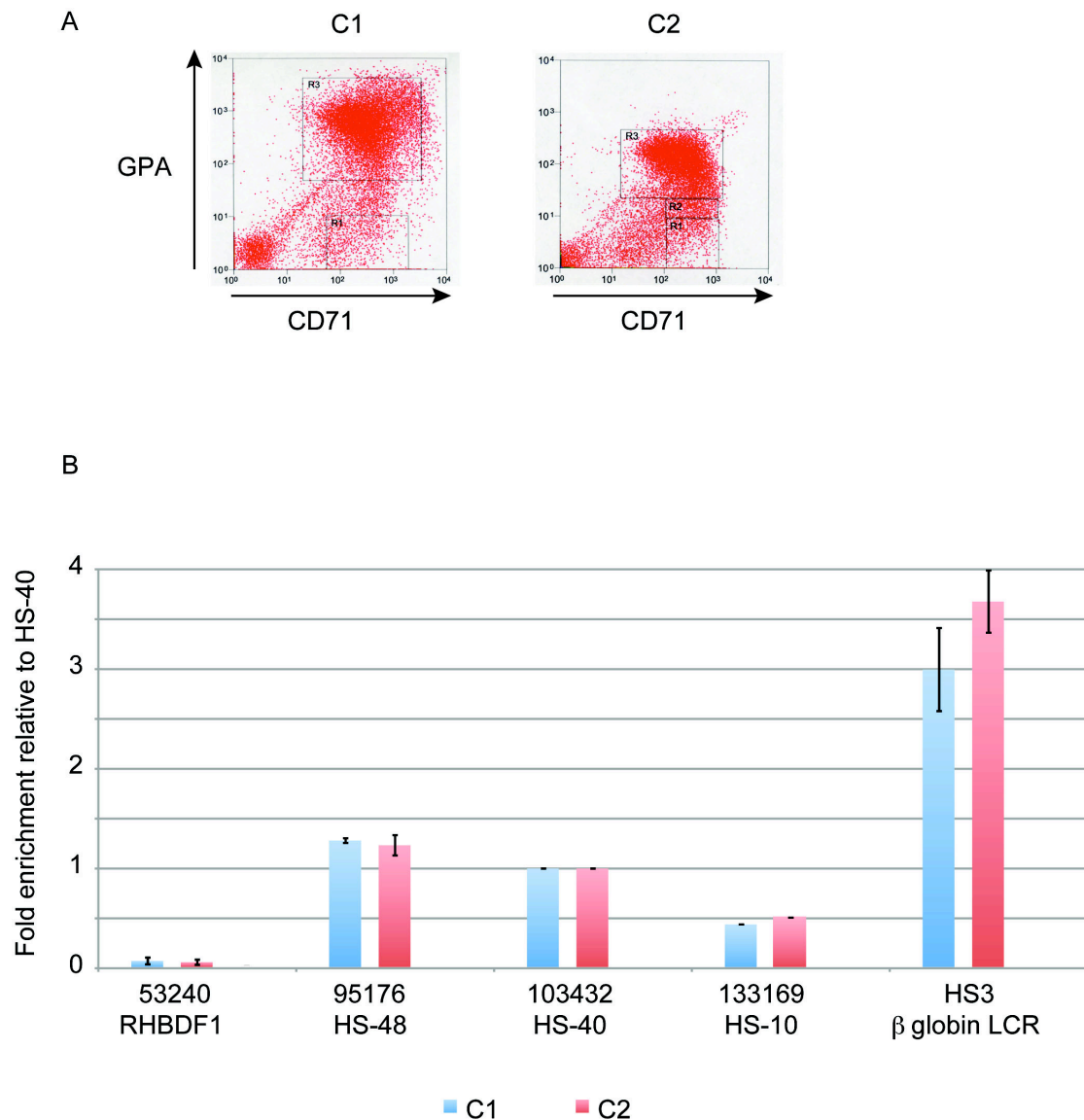

**Supp. Figure S2.** Characterization of erythroid cultures from C1 and C2.

**A.** Flow cytometry profile (CD71, x-axis, and GPA, y-axis) of C1 and C2 erythroblast cultures shows homogeneity of the maturation stage across the two cultures. The whole-cell culture was used for ChIP assays.

**B.** ChIP-qPCR validation at selected regions at the a and b globin loci. The y-axis represents the enrichment over input DNA, normalized to the HS-40 positive control sequence.

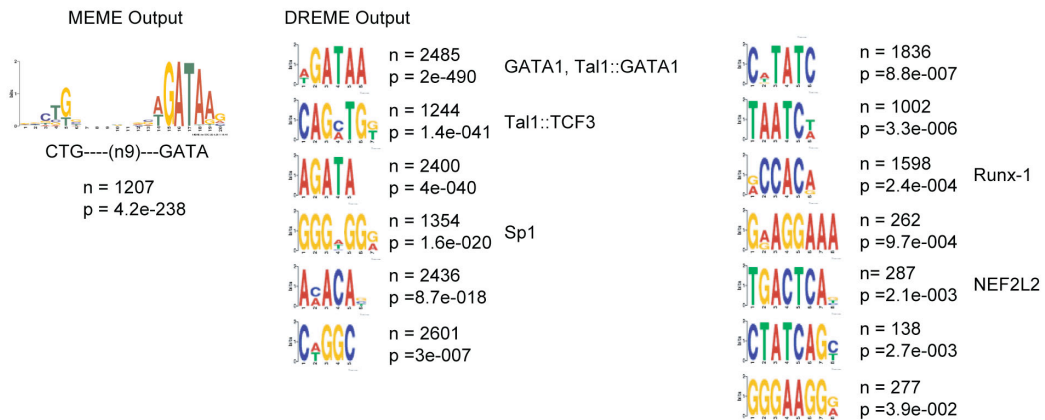

**Supp. Figure S3.** DNA motifs underlying Scl/TAL1 occupancy. For each Scl/TAL1 bound region, we extracted the peak sequence and used it for searching *de novo* motifs with the MEME/DREME software (<http://meme.ebi.edu.au/meme>). MEME is able to find relatively long composite motifs, whereas DREME is a motif discovery algorithm specifically designed to find short DNA-binding motifs. Logos identified by MEME/DREME motif search are shown together with the recognizing TF, as predicted by JASPAR CORE 2009, the corresponding p-values and the number (n) of the Scl/TAL1 peaks harbouring each motif one or more time.

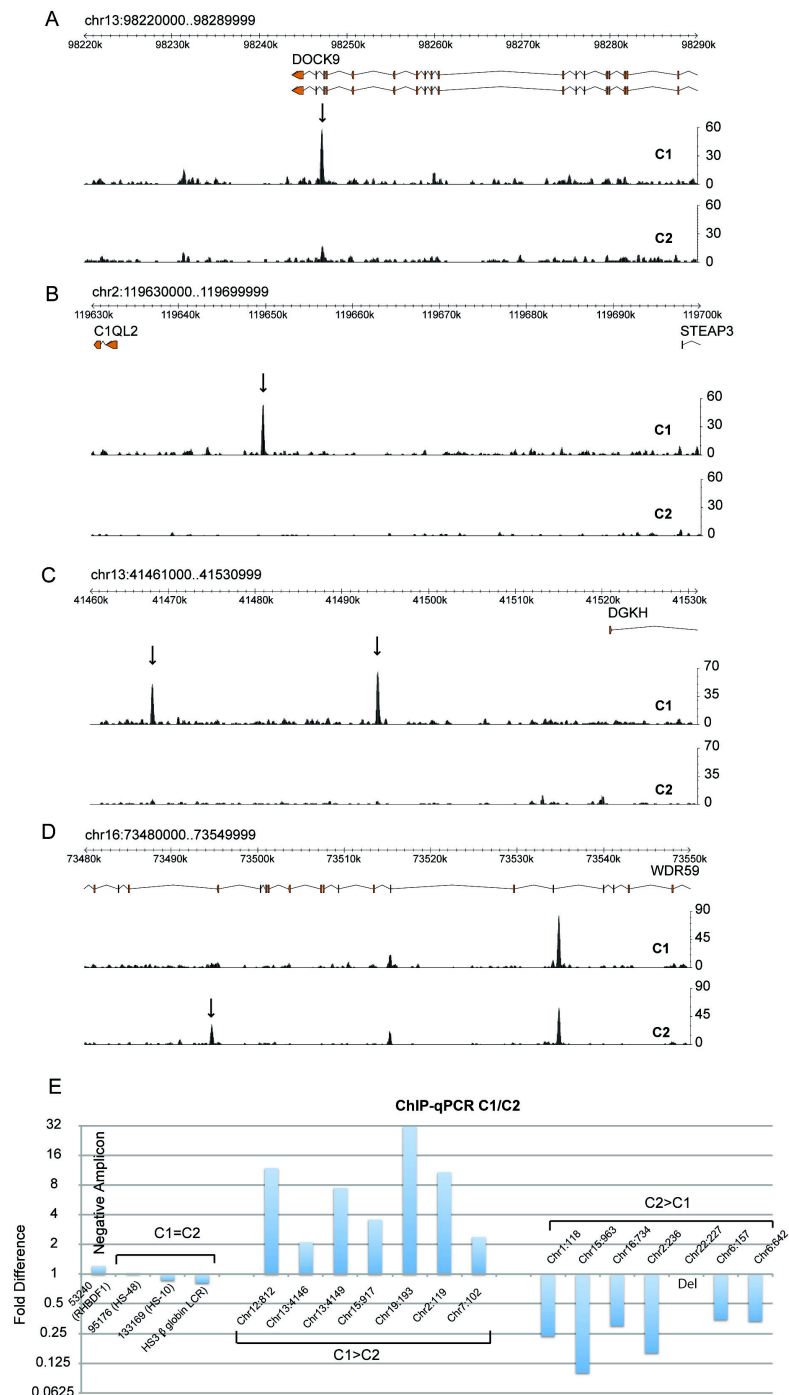

**Supp. Figure S4.** Examples of differential Scl/TAL1 binding.

**A-D.** The loci are annotated as in Fig. 1A. Differential peaks are indicated by a vertical arrow.

**E.** qPCR validation of a subset of Scl/TAL1 differentially bound regions. For each region, the ratio between the fold enrichment, as measured by comparison with HS-40 at a-globin locus, observed in C1 and in C2 is plotted on a log<sub>2</sub> scale. Del = region deleted in C1, C1/C2 ratio not calculated. Primer sequences can be found in Table S1.

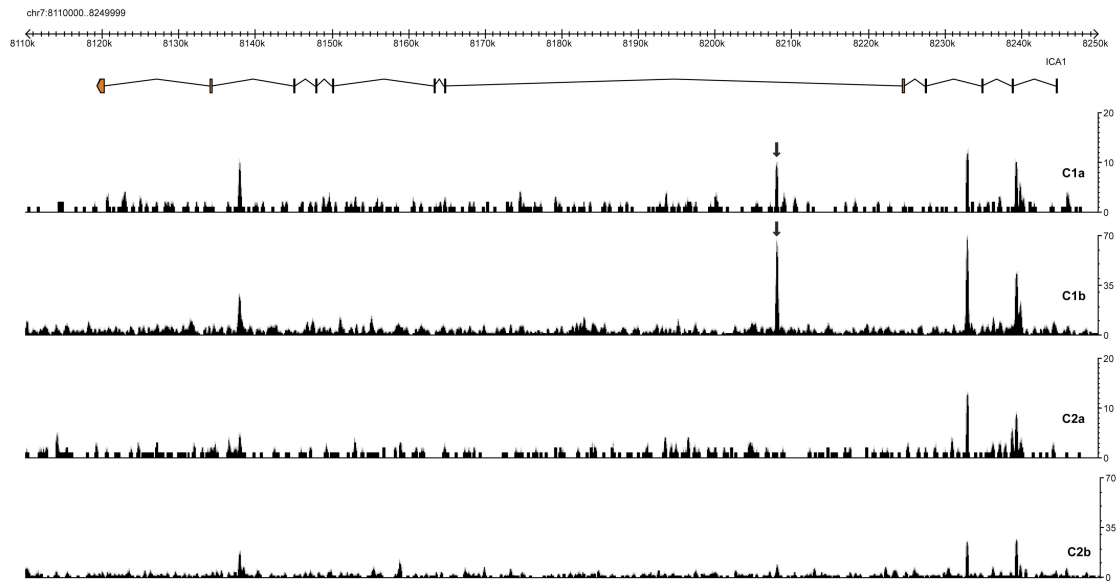

**Supp. Figure S5.** Examples of differential Scl/TAL1 binding patterns in the two sets of replicates (C1>C2).

The locus is annotated as in Fig. 1A. Differential peaks are indicated by a vertical arrow.

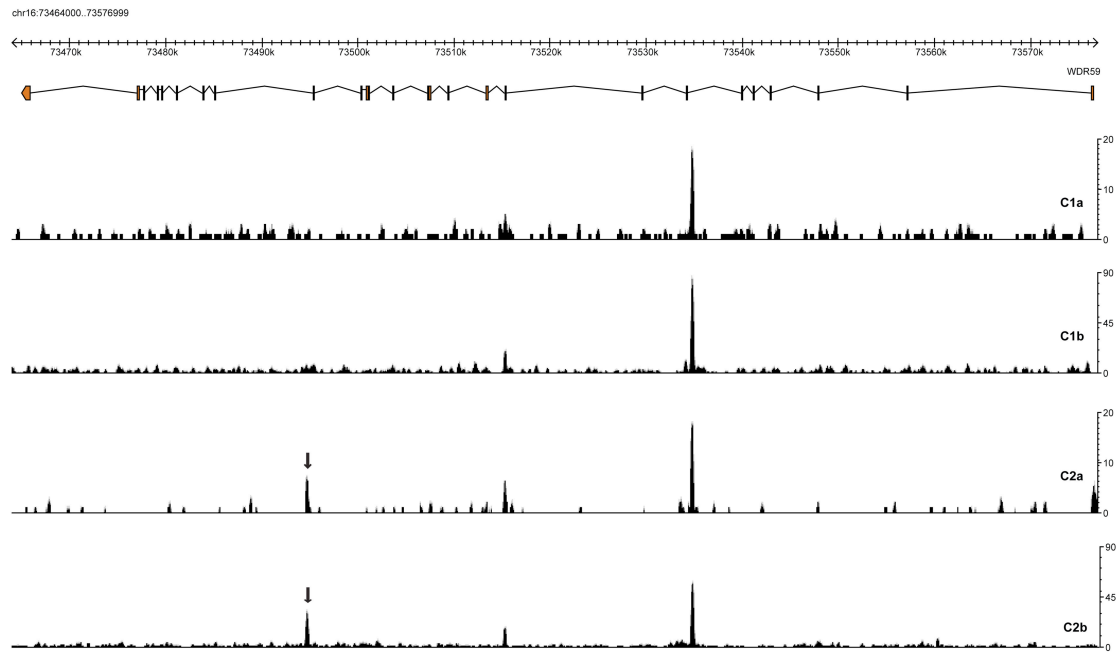

**Supp. Figure S6.** Examples of differential ScI/TAL1 binding patterns in the two sets of replicates (C2>C1).

The locus is annotated as in Fig. 1A. Differential peaks are indicated by a vertical arrow.

**Table S1.** Primer sequences for ChIP analysis

ChIP amplicon	Forward Primer	Reverse Primer	Probe	5' label	3' label
103432 (HS-40)	CAGGCTCCAGGCCCATATC	CCTCCTGCACTGTCTTTGAC	TGCCCAAGAGCTCCTTCTGCAACC	6-FAM	TAMRA
162909 ( $\alpha$ globin promoter)	GGGCCGGCACTCTTCTG	GGCCTTGACGTTGGTCTTGT	CCCACAGACTCAGAGAGAACCCACCATG	6-FAM	TAMRA
389776 (eNME4)	CCCCAACCAATTATCTCTCGCT	CGGTGTGTCCAATCATGGC	AGGGTACAATGTCTGCCGCGCCTC	6-FAM	TAMRA
401563 (DECR2)	TTCCCAAACGGTGTCAAAGG	CAAGAAGCGGGAGCAGTACCT	CTGCCGGATTTTCGCATCCTTCTCTG	6-FAM	TAMRA
53240 (RHBDF1)	GAGATGCTGGAGTCAGGACCAT	AGGAGTCAGGAGCAGCAGTCA	TCCTAGCTCACCCAGAGGCACAGAGG	6-FAM	TAMRA
95176 (HS-48)	TCCTGACAATGACTATGCAAAAGG	TGCACATTTCTGTCTTGGAGATG	ATGGCTGGCTTCAAACACACTCTCGC	6-FAM	TAMRA
133169 (HS-10)	TGGCAGGATAGGAGGCCTTA	ATGGCGGTGGCCCTTT	CCCAGACCAAGTGGCAGGACCG	6-FAM	TAMRA
HS3 ( $\beta$ globin LCR)	GTCTCTAAGGACTTGGATTTCAAGGA	CACACCAGCTCGCAAAGTCA	TTGACTCAGCAAACACAAGACCCTCACG	6-FAM	TAMRA
Chr12:812	AGCTTTCTGGGCAGACTTGGT	TCAAGCCTGCCTCATTACAACA	N/A		
Chr13:4146	TTGGAGAAGCAGTGCAGACTGT	CCAGAGGCCCAATTTGTCA	N/A		
Chr13:4149	GGCTTATCAGTTGGTACAGAAACA	GGGCAACTGCTGTCTGCAT	N/A		
Chr15:917	GCCCTTCTTATCTGCACCAGTT	AACCAATTGCTGGTGAAGGAA	CTGCCACATGGCTTGCAGTTGCTTC	6-FAM	TAMRA
Chr19:193	TCGTAGCAGTGGCAGCTGAAT	GCTCACTACCCCTAAAACCAAAGA	N/A		
Chr2:119	GCCACTGTAGCTGGGATCATAGA	ACACAGACTGACTGACTCTCTTCCA	N/A		
Chr7:102	GGCAAGCTGCTGCTTTCTG	TGGGTATGTGTGTTGGGTTACAC	N/A		
Chr1:118	TCGTTCAAGTGACGTCATTCTTCTC	AAGCATGAATGCCCAATGC	CTGGCCCGCCCCCTCTGAC	6-FAM	TAMRA
Chr15:963	GGCTTCACTCTACCAAATCATT	GAGTCACATGTGGGAAAGAGAGAA	N/A		
Chr16:734	TTTGTGCAGTGCTCAGTGGTAA	TTGGTGCCAACCATGTAGAGAA	N/A		
Chr2:236	TGAAGATAAGAGCAAAGCTGTGGT	CCCTTAAATTCTGGTCCTTTGTCA	N/A		
Chr22:227	GGCCATCTTCCAAGCCCTAT	GTGGGTCCAGGTATCAGAACGT	N/A		
Chr6:157	AGTCACGGCTTGCAGAATGA	AGAACCGCTGTGCCTCTAGTG	N/A		
Chr6:642	TGGCTATCTATCATGTCCACAAAGAG	CACTAGTCATGAGCTGCAGTTCCT	N/A		

N/A amplicons were analysed with SybrGreen Mastermix (Applied Biosystems).

**Table S2.** Oligonucleotide sequences for electrophoretic mobility shift and super-shift assays.

<b>Oligo name</b>	<b>Forward Strand</b>	<b>Reverse Strand</b>
rs2071914:G	GGCCAGCAAAG <b>GG</b> AGGGGCCCTGGATTGAG	GGCTCAATCCAGGGCCCCTCCCTTTGCTGG
rs2071914:C	GGCCAGCAAAG <b>CG</b> AGGGGCCCTGGATTGAG	GGCTCAATCCAGGGCCCCTCGCTTTGCTGG



**Table S3.** 2936 Scl/TAL1 bound regions identified by ChIP-Seq analysis

Known Scl/TAL1 Targets	hg18 build sequence			Normalised number of reads in each Scl/TAL				
	Chromosom	Start	End	Differential	C1a	C1b	C2a	C2b
	chr1	101366601	101366877		43.763218	46	15.054323	8.355864
	chr1	101521711	101521988		74.39747	37	70.25351	33.423454
	chr1	108241745	108242034		74.39747	73	65.235405	86.900986
	chr1	109478588	109478955		65.64483	60	25.09054	43.450493
	chr1	109542126	109542513		91.902756	100	60.217293	86.900986
	chr1	109967199	109967510		61.268505	37	30.108646	25.06759
	chr1	111956178	111956448		61.268505	49	20.072432	51.806355
	chr1	112087940	112088194		30.634253	37	10.036216	25.06759
	chr1	113433143	113433521		61.268505	89	65.235405	75.202774
	chr1	114258338	114258755		144.41862	217	125.4527	259.03177
	chr1	114422423	114422708		56.89218	52	65.235405	66.84691
	chr1	114424686	114425074		43.763218	57	25.09054	58.491047
	chr1	114452221	114452549		113.78436	90	70.25351	70.189255
	chr1	115999526	115999779		39.386894	19	30.108646	38.436974
	chr1	116137314	116137657		48.13954	48	70.25351	43.450493
	chr1	116777359	116777712		52.51586	62	60.217293	75.202774
	chr1	11679822	11680091		35.010574	48	20.072432	58.491047
	chr1	116820573	116820845		21.881609	42	15.054323	15.040555
	chr1	116845744	116846028		214.43977	122	155.56134	120.32444
	chr1	116848173	116848415		96.27908	81	100.36216	86.900986
	chr1	116917579	116917900		83.150116	109	75.27162	108.62623
	chr1	11780463	11780803		214.43977	120	180.65189	130.35147

chr1	117955215	117955635		96.27908	121	35.126755	93.58567
chr1	117956759	117957177		39.386894	76	20.072432	75.202774
chr1	117957416	117957740		65.64483	54	60.217293	25.06759
chr1	117989191	117989533		35.010574	40	20.072432	40.108147
chr1	118004013	118004387		26.25793	64	20.072432	58.491047
chr1	11823982	11824390	YES qPCR	17.505287	23	150.54324	180.48665
chr1	11824859	11825268		65.64483	93	115.41648	142.04968
chr1	11865494	11865786		35.010574	31	55.19919	38.436974
chr1	1187398	1187726		17.505287	42	50.18108	33.423454
chr1	11890891	11891186		65.64483	73	65.235405	70.189255
chr1	11980038	11980454		56.89218	81	90.32594	113.63975
chr1	11988079	11988587		166.30023	215	205.74242	267.38763
chr1	120081264	120081688		52.51586	67	75.27162	58.491047
chr1	120218377	120218630		13.128965	35	10.036216	46.792835
chr1	12431430	12431874		83.150116	130	115.41648	110.2974
chr1	143245551	143245834		74.39747	32	15.054323	21.725246
chr1	143715448	143715837		61.268505	50	80.28973	68.51808
chr1	143720843	143721244		157.54758	216	110.39838	177.14432
chr1	143735409	143735699		52.51586	54	30.108646	25.06759
chr1	143741409	143741800		17.505287	33	15.054323	18.3829
chr1	143768485	143768783		52.51586	63	70.25351	43.450493
chr1	144003163	144003565		26.25793	35	10.036216	18.3829
chr1	144151482	144151844		13.128965	16	10.036216	31.752281
chr1	144317489	144317805		118.16069	62	65.235405	85.22981
chr1	147490335	147490688		48.13954	54	5.018108	50.13518
chr1	149216207	149216543		52.51586	42	40.144863	33.423454

chr1	149609592	149609843	70.02115	88	55.19919	76.87395
chr1	149954431	149954845	35.010574	86	45.16297	68.51808
chr1	149955920	149956195	39.386894	35	40.144863	36.7658
chr1	150013481	150013936	39.386894	51	45.16297	31.752281
chr1	151298481	151298767	26.25793	57	40.144863	83.55864
chr1	151354461	151354768	4.376322	42	15.054323	23.396418
chr1	152396823	152397199	26.25793	39	40.144863	25.06759
chr1	152623838	152624142	17.505287	41	40.144863	43.450493
chr1	152787171	152787543	70.02115	80	105.380264	100.27036
chr1	152955116	152955421	52.51586	52	80.28973	45.121662
chr1	153123095	153123437	74.39747	57	115.41648	50.13518
chr1	153537730	153538031	52.51586	36	110.39838	40.108147
chr1	154057764	154058075	8.752644	34	25.09054	38.436974
chr1	154136611	154136989	21.881609	70	45.16297	60.16222
chr1	155114132	155114542	87.526436	89	100.36216	135.36499
chr1	155131478	155131826	70.02115	69	55.19919	85.22981
chr1	15623270	15623525	39.386894	34	55.19919	36.7658
chr1	156392094	156392416	96.27908	95	95.34405	125.33795
chr1	156922970	156923270	52.51586	48	30.108646	53.477528
chr1	156928367	156928729	170.67654	111	140.50702	125.33795
chr1	157055983	157056279	13.128965	38	30.108646	15.040555
chr1	157440527	157441035	21.881609	49	20.072432	25.06759
chr1	157441128	157441485	148.79494	124	90.32594	120.32444
chr1	157503235	157503606	61.268505	40	80.28973	50.13518
chr1	157525551	157525832	8.752644	34	45.16297	18.3829
chr1	157544080	157544410	30.634253	55	35.126755	38.436974

chr1	15827137	15827499	83.150116	63	60.217293	51.806355
chr1	158282846	158283289	175.05287	168	265.95972	182.15782
chr1	158562930	158563225	91.902756	97	55.19919	68.51808
chr1	158776533	158776977	236.32138	218	185.67	235.63536
chr1	159059697	159060078	105.03172	109	110.39838	116.98209
chr1	159094596	159094940	96.27908	106	70.25351	80.21629
chr1	159181401	159181785	70.02115	73	40.144863	50.13518
chr1	159250207	159250599	21.881609	45	30.108646	50.13518
chr1	159402769	159403277	358.8584	226	431.55728	262.3741
chr1	160181783	160182115	35.010574	60	35.126755	68.51808
chr1	160269812	160270123	26.25793	33	30.108646	13.369382
chr1	160609225	160609503	17.505287	65	15.054323	48.46401
chr1	16253161	16253436	21.881609	37	55.19919	48.46401
chr1	162947989	162948573	258.20297	245	281.01404	205.55424
chr1	163008495	163008898	43.763218	38	25.09054	25.06759
chr1	163010604	163010935	65.64483	53	35.126755	71.86043
chr1	16342904	16343211	48.13954	35	70.25351	41.77932
chr1	163881719	163882184	140.0423	117	130.47081	90.243324
chr1	16442261	16442506	35.010574	64	70.25351	78.54512
chr1	16447843	16448262	52.51586	92	50.18108	83.55864
chr1	164820820	164821080	17.505287	42	10.036216	30.08111
chr1	165779120	165779370	13.128965	36	15.054323	16.711727
chr1	165784311	165784563	91.902756	50	65.235405	61.833393
chr1	167429358	167429638	56.89218	57	55.19919	56.819874
chr1	169919621	169920005	21.881609	69	30.108646	36.7658
chr1	170683437	170683769	61.268505	42	110.39838	78.54512

chr1	170692060	170692617	258.20297	244	195.7062	289.11288
chr1	170702099	170702345	43.763218	40	35.126755	50.13518
chr1	170751246	170751549	30.634253	69	50.18108	76.87395
chr1	171057348	171057752	118.16069	91	85.30783	81.88747
chr1	171665547	171666007	35.010574	85	40.144863	31.752281
chr1	172402734	172403078	65.64483	114	110.39838	123.66679
chr1	173417901	173418291	13.128965	38	10.036216	35.094627
chr1	173644798	173645075	17.505287	29	25.09054	31.752281
chr1	173653115	173653451	109.40804	100	90.32594	93.58567
chr1	17608386	17608729	21.881609	32	80.28973	26.738764
chr1	176775953	176776405	166.30023	171	140.50702	225.60832
chr1	177282748	177283219	236.32138	198	321.1589	242.32005
chr1	179159614	179159985	48.13954	84	65.235405	108.62623
chr1	179168976	179169325	122.53701	60	115.41648	71.86043
chr1	179388684	179389147	122.53701	109	140.50702	75.202774
chr1	180362048	180362449	65.64483	84	35.126755	96.92802
chr1	180471971	180472382	87.526436	111	65.235405	123.66679
chr1	180493114	180493413	17.505287	44	40.144863	16.711727
chr1	180527297	180527655	30.634253	71	50.18108	83.55864
chr1	180535793	180536140	157.54758	120	155.56134	121.99561
chr1	180857888	180858181	30.634253	72	20.072432	68.51808
chr1	181027417	181027835	166.30023	134	125.4527	135.36499
chr1	181075636	181075879	83.150116	63	80.28973	68.51808
chr1	184431292	184431617	21.881609	61	25.09054	45.121662
chr1	184699723	184700039	35.010574	53	25.09054	36.7658
chr1	188838099	188838369	30.634253	35	25.09054	26.738764

chr1	190059458	190060005	148.79494	115	145.52513	127.009125
chr1	190513484	190513761	39.386894	54	35.126755	65.175735
chr1	191305714	191305993	91.902756	38	100.36216	40.108147
chr1	195677677	195677998	131.28966	41	75.27162	43.450493
chr1	196904899	196905218	39.386894	38	15.054323	23.396418
chr1	198389930	198390247	26.25793	30	15.054323	38.436974
chr1	198461934	198462263	65.64483	61	80.28973	30.08111
chr1	199389591	199389851	26.25793	39	25.09054	41.77932
chr1	200120230	200120559	61.268505	45	40.144863	41.77932
chr1	200311775	200312193	35.010574	80	55.19919	63.504562
chr1	20069098	20069427	78.77379	40	30.108646	23.396418
chr1	200990127	200990369	30.634253	22	15.054323	65.175735
chr1	201094592	201094868	52.51586	41	60.217293	28.409937
chr1	201180100	201180755	135.66597	248	125.4527	299.13992
chr1	201536137	201536556	65.64483	82	40.144863	33.423454
chr1	201539141	201539570	26.25793	34	10.036216	25.06759
chr1	201547472	201547965	135.66597	178	105.380264	163.77493
chr1	202035793	202036099	26.25793	37	25.09054	30.08111
chr1	202239569	202239911	65.64483	64	80.28973	78.54512
chr1	202463115	202463435	39.386894	55	30.108646	30.08111
chr1	202908081	202908584	301.96622	225	240.86917	177.14432
chr1	203220189	203220551	21.881609	35	60.217293	46.792835
chr1	203392902	203393235	122.53701	93	75.27162	81.88747
chr1	203474012	203474258	21.881609	32	10.036216	10.027037
chr1	203491582	203492158	179.4292	197	155.56134	265.71646
chr1	203580223	203580548	87.526436	122	70.25351	115.31092

chr1	203914393	203914673	13.128965	61	95.34405	86.900986
chr1	204891921	204892426	131.28966	134	175.63377	100.27036
chr1	204899432	204899773	91.902756	108	135.4889	108.62623
chr1	204913249	204913550	43.763218	47	55.19919	43.450493
chr1	205257632	205257910	13.128965	22	20.072432	38.436974
chr1	205264246	205264677	100.6554	146	100.36216	132.02264
chr1	205866197	205866565	35.010574	118	55.19919	147.0632
chr1	206113330	206113832	170.67654	111	160.57945	98.59919
chr1	206577916	206578219	21.881609	40	55.19919	30.08111
chr1	207885765	207886162	113.78436	106	95.34405	105.28388
chr1	207967865	207968106	52.51586	37	40.144863	20.054073
chr1	209567614	209567910	21.881609	37	45.16297	25.06759
chr1	209854688	209855040	70.02115	95	45.16297	81.88747
chr1	209870142	209870557	78.77379	55	50.18108	63.504562
chr1	209870833	209871093	48.13954	27	85.30783	33.423454
chr1	211222449	211222745	26.25793	36	40.144863	28.409937
chr1	211292807	211293102	17.505287	36	25.09054	28.409937
chr1	212659648	212660051	201.3108	158	155.56134	147.0632
chr1	212679344	212679746	17.505287	39	15.054323	36.7658
chr1	212842776	212843051	26.25793	44	30.108646	73.5316
chr1	21465216	21465593	96.27908	57	95.34405	48.46401
chr1	216544516	216544871	39.386894	62	0	50.13518
chr1	21730422	21730696	87.526436	121	90.32594	172.1308
chr1	218146826	218147226	52.51586	76	65.235405	70.189255
chr1	218147503	218147777	35.010574	42	40.144863	38.436974
chr1	21886794	21887199	61.268505	79	90.32594	91.9145

chr1	219206789	219207192	70.02115	95	35.126755	103.61271
chr1	222043300	222043755	109.40804	127	60.217293	140.37851
chr1	222414730	222415029	70.02115	72	55.19919	53.477528
chr1	222646893	222647287	43.763218	97	60.217293	91.9145
chr1	222727207	222727437	78.77379	27	30.108646	36.7658
chr1	222757735	222758232	258.20297	202	215.77864	183.829
chr1	223682488	223682878	507.65332	30	506.8289	41.77932
chr1	224182698	224183152	258.20297	157	225.81485	200.54073
chr1	224253674	224254131	345.72943	153	406.46674	152.07672
chr1	224614643	224615171	113.78436	93	140.50702	113.63975
chr1	225059140	225059544	74.39747	103	55.19919	83.55864
chr1	225514761	225515327	78.77379	82	95.34405	68.51808
chr1	226399935	226400309	131.28966	98	110.39838	121.99561
chr1	2267051	2267311	8.752644	41	30.108646	55.1487
chr1	226767525	226768020	245.07402	230	235.85107	243.99123
chr1	227206613	227206969	78.77379	78	65.235405	101.941536
chr1	227757187	227757946	262.5793	269	270.9778	325.8787
chr1	227956082	227956513	179.4292	155	95.34405	202.2119
chr1	228329410	228329778	91.902756	157	55.19919	157.09024
chr1	228345913	228346322	183.80551	177	195.7062	200.54073
chr1	229119008	229119299	83.150116	72	55.19919	65.175735
chr1	229362498	229362887	118.16069	158	115.41648	148.73438
chr1	232723408	232723656	48.13954	74	15.054323	80.21629
chr1	232807249	232807677	100.6554	79	110.39838	50.13518
chr1	232933096	232933416	109.40804	72	120.434586	63.504562
chr1	232975054	232975479	91.902756	144	70.25351	172.1308



chr1	233078718	233079061	100.6554	107	65.235405	111.968575
chr1	234005235	234005621	35.010574	36	50.18108	30.08111
chr1	234050042	234050281	52.51586	24	45.16297	35.094627
chr1	234167099	234167480	8.752644	33	5.018108	25.06759
chr1	23713206	23713496	87.526436	69	60.217293	68.51808
chr1	23723830	23724240	96.27908	88	80.28973	78.54512
chr1	23977010	23977290	65.64483	105	65.235405	132.02264
chr1	244399033	244399280	4.376322	19	0	36.7658
chr1	246085102	246085556	52.51586	116	70.25351	123.66679
chr1	247174767	247175058	30.634253	35	35.126755	30.08111
chr1	2507084	2507355	48.13954	32	50.18108	30.08111
chr1	26321452	26321729	56.89218	41	35.126755	45.121662
chr1	26325344	26325735	43.763218	61	40.144863	46.792835
chr1	26577416	26577920	39.386894	86	40.144863	73.5316
chr1	26607662	26608002	52.51586	33	170.61566	45.121662
chr1	26743865	26744184	52.51586	55	25.09054	78.54512
chr1	26922505	26922796	21.881609	29	30.108646	36.7658
chr1	26943151	26943439	4.376322	50	30.108646	40.108147
chr1	26990645	26990997	43.763218	42	40.144863	35.094627
chr1	27273416	27273719	30.634253	58	25.09054	56.819874
chr1	27314806	27315059	13.128965	34	10.036216	15.040555
chr1	27568157	27568393	21.881609	34	25.09054	30.08111
chr1	27741808	27742088	13.128965	104	20.072432	85.22981
chr1	28436081	28436361	8.752644	42	20.072432	46.792835
chr1	28477870	28478172	26.25793	47	35.126755	51.806355
chr1	28847609	28847981	126.91333	85	75.27162	81.88747

chr1	29082942	29083320	293.21356	197	361.30377	240.64888
chr1	29232039	29232376	74.39747	40	55.19919	41.77932
chr1	29401923	29402207	43.763218	48	35.126755	48.46401
chr1	30374391	30374796	39.386894	38	40.144863	81.88747
chr1	31014370	31014752	126.91333	201	115.41648	193.85603
chr1	31592246	31592572	87.526436	45	40.144863	50.13518
chr1	3532079	3532370	39.386894	45	25.09054	21.725246
chr1	3681218	3681525	109.40804	48	150.54324	75.202774
chr1	37801241	37801506	13.128965	39	20.072432	25.06759
chr1	37927865	37928297	39.386894	69	95.34405	80.21629
chr1	38161025	38161393	74.39747	48	45.16297	70.189255
chr1	39054041	39054470	39.386894	73	35.126755	80.21629
chr1	39153750	39154020	48.13954	67	35.126755	46.792835
chr1	39285850	39286152	26.25793	38	25.09054	30.08111
chr1	39434534	39434836	30.634253	40	40.144863	28.409937
chr1	39995738	39996209	201.3108	227	230.83296	223.93715
chr1	40274876	40275162	52.51586	42	45.16297	40.108147
chr1	40295750	40296073	35.010574	43	45.16297	21.725246
chr1	40872145	40872608	65.64483	72	125.4527	53.477528
chr1	40947404	40947674	8.752644	31	35.126755	30.08111
chr1	41059119	41059626	192.55817	226	245.88728	279.08585
chr1	42120294	42120680	74.39747	101	70.25351	75.202774
chr1	43063305	43063982	245.07402	219	260.94162	208.89659
chr1	43163181	43163605	109.40804	74	80.28973	75.202774
chr1	43174470	43174873	70.02115	72	105.380264	110.2974
chr1	43190620	43191103	91.902756	70	80.28973	66.84691

	chr1	43201181	43201582	280.0846	215	210.76053	280.75702
	chr1	43307823	43308157	13.128965	32	5.018108	20.054073
	chr1	43605505	43605918	183.80551	91	155.56134	113.63975
	chr1	43691364	43691621	17.505287	32	70.25351	13.369382
	chr1	44196685	44196933	30.634253	29	40.144863	40.108147
	chr1	44274122	44274572	188.18184	142	170.61566	192.18486
	chr1	44465492	44465815	17.505287	41	40.144863	51.806355
	chr1	44723903	44724241	65.64483	27	30.108646	41.77932
	chr1	44876196	44876501	223.19241	118	250.9054	121.99561
	chr1	44935292	44935558	26.25793	40	25.09054	43.450493
	chr1	45069301	45069563	39.386894	40	60.217293	46.792835
	chr1	45250836	45251346	231.94505	107	210.76053	110.2974
	chr1	45273910	45274425	105.03172	132	130.47081	118.65327
	chr1	46681051	46681353	35.010574	40	70.25351	25.06759
	chr1	46850179	46850620	126.91333	104	190.6881	123.66679
	chr1	46911037	46911288	35.010574	22	45.16297	31.752281
	chr1	46911962	46912285	43.763218	60	40.144863	70.189255
ScI/TAL-1	chr1	47419361	47420070	586.4271	297	587.11865	334.23456
ScI/TAL-1 promoter	chr1	47470533	47470841	468.26642	44	481.73834	68.51808
	chr1	51205252	51205589	78.77379	57	45.16297	21.725246
	chr1	51522648	51523143	131.28966	111	85.30783	152.07672
	chr1	54613928	54614198	56.89218	41	60.217293	36.7658
	chr1	54634575	54634918	39.386894	50	20.072432	51.806355
	chr1	54635248	54635686	109.40804	163	115.41648	167.11728
	chr1	55385089	55385323	52.51586	33	25.09054	40.108147
	chr1	55430446	55430705	39.386894	35	5.018108	30.08111

chr1	57456916	57457369	135.66597	170	100.36216	148.73438
chr1	60205647	60205999	65.64483	51	35.126755	41.77932
chr1	61133037	61133399	39.386894	41	30.108646	20.054073
chr1	61251454	61251941	214.43977	210	270.9778	212.23894
chr1	61287241	61287483	43.763218	74	60.217293	76.87395
chr1	61354525	61355072	105.03172	127	145.52513	100.27036
chr1	61378170	61378622	91.902756	133	155.56134	123.66679
chr1	61408945	61409263	56.89218	78	45.16297	80.21629
chr1	61419689	61420009	122.53701	59	95.34405	43.450493
chr1	62777408	62777754	43.763218	75	15.054323	45.121662
chr1	62928564	62928878	39.386894	68	35.126755	45.121662
chr1	65463127	65463499	39.386894	35	10.036216	20.054073
chr1	65469369	65469764	56.89218	77	60.217293	85.22981
chr1	65650786	65651066	74.39747	43	70.25351	41.77932
chr1	65707569	65707864	21.881609	42	20.072432	31.752281
chr1	65815598	65815926	105.03172	46	125.4527	45.121662
chr1	6649361	6649672	91.902756	76	70.25351	85.22981
chr1	6655126	6655618	428.87955	294	331.19513	302.48227
chr1	66651473	66651768	43.763218	32	60.217293	46.792835
chr1	66771983	66772265	65.64483	48	85.30783	68.51808
chr1	66996511	66996819	26.25793	52	35.126755	38.436974
chr1	67926891	67927186	21.881609	43	60.217293	58.491047
chr1	67971914	67972660	214.43977	332	225.81485	344.2616
chr1	69778276	69778749	113.78436	155	135.4889	155.41907
chr1	72120051	72120383	35.010574	31	35.126755	16.711727
chr1	75710690	75711007	30.634253	36	45.16297	65.175735

chr1	78291069	78291342	100.6554	38	65.235405	36.7658
chr1	84926875	84927298	61.268505	114	70.25351	132.02264
chr1	8524812	8525141	135.66597	112	120.434586	100.27036
chr1	85463332	85463747	70.02115	146	110.39838	118.65327
chr1	87418447	87418784	35.010574	52	90.32594	46.792835
chr1	88919220	88919495	126.91333	45	55.19919	28.409937
chr1	89438954	89439331	39.386894	52	30.108646	16.711727
chr1	90061760	90062094	56.89218	60	30.108646	51.806355
chr1	90213676	90214003	26.25793	28	45.16297	31.752281
chr1	92684739	92685110	30.634253	49	55.19919	33.423454
chr1	93478048	93478335	70.02115	33	40.144863	41.77932
chr1	93685134	93685479	39.386894	72	40.144863	48.46401
chr1	93898334	93898728	48.13954	38	45.16297	15.040555
chr1	93902551	93903149	100.6554	92	90.32594	76.87395
chr1	94238727	94239036	13.128965	31	15.054323	30.08111
chr1	94251247	94251544	26.25793	42	30.108646	30.08111
chr1	94262186	94262705	538.2876	311	486.75647	374.34268
chr1	94873176	94873458	96.27908	49	100.36216	50.13518
chr1	95131020	95131468	140.0423	159	90.32594	167.11728
chr1	95323547	95323966	78.77379	112	75.27162	121.99561
chr1	95353659	95354145	100.6554	105	150.54324	100.27036
chr10	100210632	100211044	43.763218	36	50.18108	11.698209
chr10	100212783	100213126	39.386894	116	60.217293	125.33795
chr10	100659748	100660138	105.03172	136	130.47081	118.65327
chr10	103200070	103200453	140.0423	141	75.27162	138.70734
chr10	103862128	103862385	100.6554	37	70.25351	43.450493

chr10	104349536	104349821	39.386894	38	35.126755	36.7658
chr10	104423923	104424187	30.634253	41	30.108646	43.450493
chr10	104613423	104613757	26.25793	51	15.054323	35.094627
chr10	104713346	104713682	70.02115	86	55.19919	65.175735
chr10	104738723	104739096	39.386894	84	65.235405	61.833393
chr10	105368403	105368898	175.05287	74	150.54324	113.63975
chr10	105388749	105388998	43.763218	31	40.144863	10.027037
chr10	106082207	106082484	21.881609	38	25.09054	43.450493
chr10	111648451	111648793	65.64483	91	90.32594	58.491047
chr10	111731901	111732200	52.51586	63	30.108646	46.792835
chr10	111898953	111899368	52.51586	80	100.36216	93.58567
chr10	111971057	111971363	30.634253	74	20.072432	55.1487
chr10	111971589	111972014	52.51586	74	30.108646	76.87395
chr10	112008247	112008648	48.13954	56	30.108646	60.16222
chr10	11260546	11260812	26.25793	46	25.09054	25.06759
chr10	112877221	112877553	65.64483	42	130.47081	66.84691
chr10	114272086	114272429	13.128965	34	15.054323	10.027037
chr10	114427340	114427639	8.752644	41	20.072432	23.396418
chr10	114810583	114810922	96.27908	47	40.144863	36.7658
chr10	114841474	114841983	113.78436	134	110.39838	85.22981
chr10	116675815	116676342	170.67654	107	145.52513	86.900986
chr10	119125950	119126246	56.89218	73	65.235405	128.6803
chr10	119158521	119158869	35.010574	43	40.144863	48.46401
chr10	119160959	119161329	175.05287	166	175.63377	198.86955
chr10	120840531	120840812	61.268505	31	45.16297	25.06759
chr10	121288115	121288422	78.77379	47	40.144863	33.423454

chr10	121406411	121406652	26.25793	32	30.108646	5.0135183
chr10	121894610	121894880	61.268505	25	40.144863	35.094627
chr10	12347849	12348122	201.3108	132	210.76053	163.77493
chr10	124661472	124661709	43.763218	33	80.28973	41.77932
chr10	126267755	126268079	43.763218	46	80.28973	60.16222
chr10	126371409	126371755	131.28966	92	180.65189	118.65327
chr10	126396454	126397181	266.95563	310	371.34	362.64447
chr10	126728103	126728333	35.010574	34	15.054323	23.396418
chr10	127495022	127495522	113.78436	109	125.4527	110.2974
chr10	127565259	127565770	17.505287	46	30.108646	48.46401
chr10	127572353	127572647	13.128965	35	10.036216	15.040555
chr10	127572653	127573177	17.505287	51	40.144863	38.436974
chr10	127573187	127573719	35.010574	51	20.072432	31.752281
chr10	127591662	127592233	35.010574	63	35.126755	48.46401
chr10	130722114	130722589	109.40804	98	130.47081	118.65327
chr10	13173880	13174209	39.386894	78	35.126755	71.86043
chr10	13497729	13497979	4.376322	25	25.09054	33.423454
chr10	13787725	13788150	293.21356	198	160.57945	220.5948
chr10	15533102	15533547	218.81609	138	145.52513	106.955055
chr10	16847514	16847854	48.13954	59	100.36216	43.450493
chr10	17539108	17539453	74.39747	55	165.59756	61.833393
chr10	17591170	17591499	35.010574	74	30.108646	63.504562
chr10	17660682	17660979	30.634253	43	25.09054	30.08111
chr10	17744798	17745170	201.3108	204	135.4889	223.93715
chr10	19064745	19065020	30.634253	31	30.108646	38.436974
chr10	23012483	23012766	56.89218	78	50.18108	50.13518

chr10	23031438	23031732	65.64483	56	35.126755	48.46401
chr10	26801222	26801499	26.25793	43	45.16297	23.396418
chr10	28823413	28823692	26.25793	45	35.126755	35.094627
chr10	29460913	29461230	43.763218	54	25.09054	36.7658
chr10	30766038	30766292	35.010574	58	45.16297	48.46401
chr10	31081540	31081913	118.16069	107	115.41648	101.941536
chr10	31150166	31150527	21.881609	34	35.126755	43.450493
chr10	33251077	33251512	157.54758	95	150.54324	93.58567
chr10	33256715	33257031	13.128965	77	50.18108	88.57216
chr10	34492137	34492384	13.128965	33	10.036216	45.121662
chr10	43796740	43796988	26.25793	19	50.18108	31.752281
chr10	45168583	45168882	56.89218	79	15.054323	41.77932
chr10	45396962	45397193	26.25793	47	20.072432	25.06759
chr10	46527682	46527935	30.634253	31	30.108646	16.711727
chr10	4880657	4880983	65.64483	38	30.108646	45.121662
chr10	4963758	4964091	26.25793	66	45.16297	55.1487
chr10	51264009	51264621	301.96622	253	270.9778	309.16696
chr10	51756586	51756999	52.51586	64	105.380264	108.62623
chr10	51980029	51980501	258.20297	258	265.95972	290.78406
chr10	51985083	51985388	87.526436	47	75.27162	40.108147
chr10	51995056	51995296	83.150116	78	55.19919	81.88747
chr10	5511566	5511845	52.51586	40	60.217293	31.752281
chr10	5578874	5579186	39.386894	44	50.18108	28.409937
chr10	5911229	5911486	35.010574	30	25.09054	38.436974
chr10	5976818	5977186	87.526436	71	50.18108	56.819874
chr10	6041882	6042226	65.64483	54	75.27162	36.7658



chr10	6063620	6063898	30.634253	42	65.235405	40.108147
chr10	6069655	6070041	96.27908	131	60.217293	127.009125
chr10	61503265	61503524	30.634253	34	45.16297	36.7658
chr10	61503710	61504030	26.25793	33	15.054323	48.46401
chr10	62408252	62408510	39.386894	34	30.108646	33.423454
chr10	63195315	63195786	131.28966	125	95.34405	130.35147
chr10	63210199	63210472	39.386894	38	20.072432	26.738764
chr10	6555401	6555739	39.386894	39	65.235405	35.094627
chr10	69283326	69283657	48.13954	107	30.108646	138.70734
chr10	69700870	69701250	65.64483	73	50.18108	66.84691
chr10	7002275	7002765	175.05287	233	175.63377	259.03177
chr10	70671882	70672191	70.02115	62	35.126755	71.86043
chr10	70722257	70722651	61.268505	65	35.126755	46.792835
chr10	70745296	70745574	30.634253	65	40.144863	75.202774
chr10	71751715	71751954	4.376322	28	5.018108	31.752281
chr10	73068552	73068844	17.505287	38	15.054323	10.027037
chr10	73176869	73177270	61.268505	64	90.32594	68.51808
chr10	73227542	73227827	70.02115	42	45.16297	45.121662
chr10	73702370	73702798	30.634253	86	25.09054	93.58567
chr10	73703588	73704010	87.526436	25	60.217293	48.46401
chr10	73704326	73704837	61.268505	14	70.25351	35.094627
chr10	73706234	73706469	8.752644	6	5.018108	31.752281
chr10	73739508	73739870	61.268505	49	35.126755	63.504562
chr10	73750336	73750599	4.376322	25	30.108646	33.423454
chr10	73750611	73750862	13.128965	44	40.144863	81.88747
chr10	74674760	74675067	65.64483	85	55.19919	86.900986

chr10	75117408	75117809	39.386894	68	35.126755	58.491047
chr10	75386289	75386673	48.13954	35	75.27162	21.725246
chr10	76283837	76284181	39.386894	44	10.036216	26.738764
chr10	77081986	77082305	74.39747	65	70.25351	70.189255
chr10	80457019	80457547	192.55817	143	175.63377	150.40555
chr10	81648137	81648417	8.752644	31	10.036216	35.094627
chr10	82234805	82235134	21.881609	40	25.09054	26.738764
chr10	82247375	82247660	91.902756	52	55.19919	40.108147
chr10	82253785	82254101	61.268505	47	65.235405	20.054073
chr10	88429182	88429489	26.25793	35	50.18108	26.738764
chr10	89250358	89250809	96.27908	151	85.30783	145.39203
chr10	91124042	91124322	52.51586	33	30.108646	28.409937
chr10	91127317	91127777	87.526436	76	65.235405	55.1487
chr10	93776923	93777237	8.752644	42	30.108646	43.450493
chr10	94506060	94506425	43.763218	61	45.16297	23.396418
chr10	97254011	97254319	70.02115	54	50.18108	50.13518
chr10	97414150	97414736	148.79494	172	205.74242	162.10376
chr10	98372125	98372517	39.386894	76	85.30783	63.504562
chr10	98438624	98438919	65.64483	78	85.30783	71.86043
chr10	98578729	98579029	48.13954	70	55.19919	46.792835
chr10	99414289	99414636	43.763218	62	85.30783	78.54512
chr10	99538706	99539085	179.4292	99	205.74242	71.86043
chr10	99986621	99987023	113.78436	192	110.39838	203.88307
chr11	100239095	100239460	140.0423	119	150.54324	121.99561
chr11	10275883	10276125	13.128965	31	0	25.06759
chr11	102829115	102829408	65.64483	46	35.126755	33.423454

chr11	10298137	10298472	39.386894	45	60.217293	45.121662
chr11	10434622	10434950	87.526436	113	85.30783	142.04968
chr11	111074803	111075210	30.634253	58	35.126755	60.16222
chr11	111104978	111105337	48.13954	49	40.144863	41.77932
chr11	111190869	111191139	17.505287	41	10.036216	16.711727
chr11	111318048	111318324	56.89218	32	80.28973	36.7658
chr11	113057132	113057653	52.51586	114	45.16297	103.61271
chr11	113458663	113459044	144.41862	138	120.434586	187.17134
chr11	113486920	113487263	56.89218	41	60.217293	45.121662
chr11	113591791	113592129	48.13954	45	30.108646	38.436974
chr11	11380347	11380735	87.526436	138	50.18108	158.76141
chr11	113825819	113826153	109.40804	47	150.54324	56.819874
chr11	116536830	116537167	30.634253	37	75.27162	25.06759
chr11	116600213	116600587	70.02115	105	50.18108	111.968575
chr11	117285926	117286191	48.13954	41	15.054323	25.06759
chr11	117791553	117791992	30.634253	50	45.16297	40.108147
chr11	117813435	117813690	43.763218	22	40.144863	36.7658
chr11	118404855	118405256	70.02115	69	70.25351	43.450493
chr11	118461425	118461758	122.53701	80	85.30783	86.900986
chr11	118463549	118464150	328.22412	331	411.48483	436.1761
chr11	118469916	118470598	126.91333	32	100.36216	38.436974
chr11	119013382	119013813	183.80551	166	210.76053	208.89659
chr11	119715480	119715819	56.89218	142	65.235405	135.36499
chr11	120412990	120413297	8.752644	60	15.054323	38.436974
chr11	12094502	12094945	78.77379	117	105.380264	143.72086
chr11	12171241	12171701	140.0423	146	105.380264	163.77493

chr11	12179262	12179693	153.17126	197	150.54324	222.26598
chr11	122131412	122131700	61.268505	65	75.27162	58.491047
chr11	12241204	12241795	43.763218	47	45.16297	85.22981
chr11	123455627	123455957	96.27908	65	105.380264	81.88747
chr11	123583273	123583627	131.28966	117	115.41648	167.11728
chr11	125795509	125795824	74.39747	86	110.39838	80.21629
chr11	1275768	1276209	118.16069	160	155.56134	153.7479
chr11	128151972	128152266	17.505287	33	40.144863	26.738764
chr11	128178174	128178477	21.881609	42	35.126755	21.725246
chr11	129452753	129453071	74.39747	123	60.217293	83.55864
chr11	129620525	129621009	35.010574	71	60.217293	88.57216
chr11	132498995	132499281	43.763218	43	30.108646	65.175735
chr11	132502867	132503216	126.91333	90	95.34405	73.5316
chr11	13745629	13745996	61.268505	103	110.39838	100.27036
chr11	14400433	14400757	26.25793	32	20.072432	65.175735
chr11	14635263	14635528	43.763218	42	45.16297	21.725246
chr11	16359327	16359648	35.010574	67	65.235405	70.189255
chr11	16360390	16360698	70.02115	47	75.27162	68.51808
chr11	16582839	16583318	223.19241	77	195.7062	91.9145
chr11	16835294	16835737	135.66597	92	125.4527	55.1487
chr11	1728400	1728739	83.150116	92	80.28973	85.22981
chr11	1756086	1756399	48.13954	39	10.036216	81.88747
chr11	20466593	20466875	17.505287	31	40.144863	23.396418
chr11	2076993	2077355	61.268505	46	125.4527	43.450493
chr11	2281410	2281784	30.634253	43	35.126755	23.396418
chr11	27350334	27350614	87.526436	55	70.25351	58.491047

	chr11	27398792	27399152	65.64483	64	55.19919	60.16222
	chr11	2756411	2756805	56.89218	42	45.16297	40.108147
	chr11	2845544	2845791	52.51586	34	60.217293	5.0135183
	chr11	2941560	2941907	30.634253	70	45.16297	65.175735
	chr11	3209584	3209983	166.30023	83	135.4889	76.87395
LMO2 Enhancer -75	chr11	33922799	33923311	249.45035	240	250.9054	260.70294
	chr11	34214722	34215133	131.28966	72	115.41648	56.819874
	chr11	34416569	34417199	258.20297	88	376.3581	100.27036
	chr11	34424508	34424845	61.268505	50	65.235405	60.16222
	chr11	34553439	34553694	87.526436	34	55.19919	36.7658
	chr11	36231337	36231760	113.78436	71	115.41648	73.5316
	chr11	38516965	38517357	144.41862	144	115.41648	157.09024
	chr11	3856549	3856782	13.128965	85	25.09054	60.16222
	chr11	44759124	44759464	56.89218	64	80.28973	75.202774
	chr11	44894840	44895185	39.386894	49	45.16297	43.450493
	chr11	45637876	45638235	109.40804	79	95.34405	68.51808
	chr11	45972548	45972984	35.010574	48	40.144863	50.13518
	chr11	45973546	45973986	83.150116	84	65.235405	91.9145
	chr11	46590091	46590325	35.010574	83	40.144863	68.51808
	chr11	47034430	47034777	26.25793	37	40.144863	35.094627
	chr11	47356459	47356846	65.64483	39	100.36216	36.7658
	chr11	47587775	47588119	78.77379	123	50.18108	83.55864
	chr11	47984674	47985090	183.80551	162	145.52513	147.0632
	chr11	5129491	5129922	96.27908	63	40.144863	56.819874
	chr11	5211735	5212469	131.28966	82	80.28973	68.51808
HS1 Beta-Globin LCR	chr11	5253659	5253917	26.25793	45	25.09054	58.491047

HS2 Beta-Globin LCR	chr11	5258353	5258721	183.80551	141	150.54324	207.22542
HS3 Beta-Globin LCR	chr11	5262386	5262837	192.55817	182	165.59756	165.4461
HS4 Beta-Globin LCR	chr11	5265890	5266240	26.25793	41	40.144863	65.175735
	chr11	5281401	5281824	30.634253	44	50.18108	38.436974
	chr11	56919880	56920260	30.634253	83	85.30783	50.13518
	chr11	56948752	56949115	131.28966	101	140.50702	123.66679
	chr11	57036711	57037061	61.268505	77	115.41648	91.9145
	chr11	57055332	57055606	35.010574	69	40.144863	76.87395
	chr11	57172126	57172740	284.4609	288	245.88728	394.39676
	chr11	60688408	60688713	91.902756	61	115.41648	75.202774
	chr11	60811605	60811835	48.13954	98	65.235405	105.28388
	chr11	60870653	60870956	74.39747	59	65.235405	45.121662
	chr11	60891499	60891872	96.27908	85	160.57945	111.968575
	chr11	61358579	61358938	43.763218	54	75.27162	55.1487
	chr11	61444118	61444625	65.64483	118	90.32594	108.62623
	chr11	61490577	61491084	48.13954	55	35.126755	38.436974
	chr11	61566099	61566400	83.150116	52	95.34405	55.1487
	chr11	61920809	61921060	21.881609	31	25.09054	21.725246
	chr11	6227686	6227977	96.27908	78	35.126755	46.792835
	chr11	6229830	6230348	96.27908	65	110.39838	48.46401
	chr11	62365445	62365698	35.010574	103	40.144863	110.2974
	chr11	62403433	62403724	83.150116	61	75.27162	66.84691
	chr11	63709776	63710196	17.505287	37	65.235405	18.3829
	chr11	63859057	63859524	166.30023	195	185.67	259.03177
	chr11	64413169	64413417	39.386894	58	20.072432	81.88747
	chr11	64945296	64945646	48.13954	39	55.19919	48.46401

chr11	64946741	64947599	166.30023	74	115.41648	66.84691
chr11	64948424	64949022	43.763218	66	25.09054	40.108147
chr11	64949088	64949651	35.010574	41	45.16297	21.725246
chr11	64950271	64951749	218.81609	164	145.52513	80.21629
chr11	65021839	65022144	39.386894	53	15.054323	56.819874
chr11	65027053	65027364	39.386894	30	20.072432	38.436974
chr11	65099115	65099445	78.77379	110	120.434586	105.28388
chr11	65102775	65103021	39.386894	46	40.144863	46.792835
chr11	65160302	65160585	39.386894	52	70.25351	40.108147
chr11	6541104	6541529	56.89218	37	40.144863	58.491047
chr11	65945681	65945969	83.150116	45	215.77864	46.792835
chr11	66128289	66128672	109.40804	115	175.63377	143.72086
chr11	66225971	66226209	61.268505	32	50.18108	31.752281
chr11	66432267	66432768	61.268505	95	80.28973	113.63975
chr11	66439135	66439512	48.13954	122	90.32594	132.02264
chr11	67623556	67623875	52.51586	47	10.036216	26.738764
chr11	69429132	69429538	161.9239	85	125.4527	88.57216
chr11	69505203	69505498	74.39747	28	35.126755	31.752281
chr11	69993911	69994351	109.40804	108	95.34405	88.57216
chr11	71337385	71337718	56.89218	60	35.126755	41.77932
chr11	71384359	71384745	113.78436	102	95.34405	121.99561
chr11	71800648	71800907	48.13954	45	10.036216	46.792835
chr11	71882532	71882897	153.17126	127	120.434586	121.99561
chr11	72571423	72571849	122.53701	95	85.30783	105.28388
chr11	72764670	72764931	39.386894	40	60.217293	31.752281
chr11	73369336	73369690	56.89218	58	95.34405	73.5316

chr11	73405074	73405422	100.6554	132	120.434586	143.72086
chr11	73593833	73594298	210.06345	186	115.41648	190.51369
chr11	73718685	73719186	113.78436	115	60.217293	93.58567
chr11	73826129	73826492	61.268505	79	35.126755	98.59919
chr11	73848267	73848600	13.128965	54	45.16297	60.16222
chr11	74794966	74795275	61.268505	60	60.217293	41.77932
chr11	74894502	74894748	35.010574	29	0	41.77932
chr11	74923773	74924049	48.13954	62	55.19919	66.84691
chr11	74978531	74978976	323.8478	236	245.88728	287.4417
chr11	75168726	75169076	35.010574	34	25.09054	41.77932
chr11	76089074	76089563	170.67654	240	140.50702	230.62184
chr11	76176974	76177280	39.386894	44	55.19919	41.77932
chr11	76415023	76415330	35.010574	76	40.144863	66.84691
chr11	76475817	76476246	183.80551	142	90.32594	192.18486
chr11	76814128	76814374	30.634253	34	40.144863	25.06759
chr11	8180550	8180884	39.386894	72	40.144863	85.22981
chr11	8184422	8184880	376.36368	145	446.6116	153.7479
chr11	85532381	85532612	17.505287	32	40.144863	16.711727
chr11	85537029	85537364	52.51586	59	105.380264	71.86043
chr11	85539976	85540429	161.9239	186	225.81485	220.5948
chr11	85562664	85563068	170.67654	166	190.6881	203.88307
chr11	85564724	85565194	30.634253	84	75.27162	93.58567
chr11	865958	866408	192.55817	176	125.4527	135.36499
chr11	8747087	8747372	8.752644	45	20.072432	61.833393
chr11	8772858	8773168	13.128965	18	30.108646	45.121662
chr11	8966496	8967187	96.27908	122	80.28973	138.70734



chr11	898202	898658	140.0423	149	155.56134	175.47314
chr11	8986153	8986501	26.25793	57	25.09054	43.450493
chr11	9264430	9264687	105.03172	78	120.434586	98.59919
chr11	93419258	93419549	48.13954	68	40.144863	78.54512
chr11	94459694	94460039	35.010574	49	40.144863	45.121662
chr11	94520251	94520663	61.268505	88	80.28973	50.13518
chr11	94915579	94915863	65.64483	97	50.18108	96.92802
chr11	9530001	9530301	35.010574	41	40.144863	21.725246
chr11	97372727	97373087	105.03172	103	60.217293	113.63975
chr12	100614618	100614985	91.902756	85	100.36216	127.009125
chr12	103385282	103385638	144.41862	97	165.59756	95.25684
chr12	103494900	103495150	126.91333	55	140.50702	68.51808
chr12	103516749	103517163	43.763218	63	55.19919	86.900986
chr12	105219603	105220078	175.05287	152	140.50702	140.37851
chr12	107255464	107255817	13.128965	32	35.126755	61.833393
chr12	107607280	107607640	118.16069	60	70.25351	43.450493
chr12	107609470	107609919	122.53701	115	110.39838	132.02264
chr12	107610307	107610652	65.64483	49	65.235405	50.13518
chr12	107617962	107618485	83.150116	75	15.054323	50.13518
chr12	110327494	110327779	122.53701	25	155.56134	43.450493
chr12	110558842	110559133	8.752644	58	15.054323	41.77932
chr12	111273214	111273727	131.28966	298	200.72432	347.60394
chr12	111309000	111309328	30.634253	54	50.18108	45.121662
chr12	112571467	112571892	74.39747	41	55.19919	35.094627
chr12	112855046	112855409	65.64483	73	45.16297	40.108147
chr12	115119253	115119687	148.79494	179	100.36216	152.07672

chr12	115481520	115481896	170.67654	102	135.4889	106.955055
chr12	115964349	115964923	463.8901	353	592.1367	441.1896
chr12	117252523	117252819	87.526436	95	75.27162	70.189255
chr12	118587544	118588211	201.3108	249	120.434586	265.71646
chr12	119213726	119213972	43.763218	50	25.09054	33.423454
chr12	119462563	119463029	153.17126	165	135.4889	165.4461
chr12	119642042	119642423	52.51586	55	75.27162	56.819874
chr12	120644861	120645138	39.386894	32	25.09054	33.423454
chr12	120660554	120660892	91.902756	73	90.32594	101.941536
chr12	120701134	120701579	35.010574	55	80.28973	41.77932
chr12	120793750	120794086	192.55817	184	230.83296	232.29301
chr12	121539629	121539943	52.51586	58	30.108646	68.51808
chr12	121844255	121844578	87.526436	36	65.235405	40.108147
chr12	121945107	121945429	43.763218	74	55.19919	65.175735
chr12	123541305	123541569	8.752644	38	30.108646	25.06759
chr12	125920108	125920524	30.634253	88	45.16297	115.31092
chr12	126820687	126821044	30.634253	37	25.09054	18.3829
chr12	13040490	13040864	140.0423	137	160.57945	168.78845
chr12	13105531	13106034	118.16069	174	130.47081	182.15782
chr12	14887608	14888004	126.91333	110	125.4527	133.69382
chr12	14941016	14941356	52.51586	52	80.28973	33.423454
chr12	151035	151459	105.03172	38	70.25351	35.094627
chr12	151652	152072	39.386894	101	60.217293	81.88747
chr12	15765567	15765886	61.268505	53	20.072432	26.738764
chr12	1895096	1895441	87.526436	67	75.27162	66.84691
chr12	1895835	1896141	17.505287	29	30.108646	36.7658

chr12	1896167	1896533	48.13954	60	40.144863	60.16222
chr12	1896954	1897508	109.40804	74	95.34405	60.16222
chr12	21857373	21857668	56.89218	70	70.25351	61.833393
chr12	22090921	22091328	83.150116	64	90.32594	58.491047
chr12	24994504	24994867	43.763218	46	60.217293	93.58567
chr12	2676767	2677172	87.526436	88	45.16297	78.54512
chr12	26890238	26890630	118.16069	124	205.74242	108.62623
chr12	28180325	28180603	26.25793	12	45.16297	36.7658
chr12	28236321	28236766	56.89218	87	25.09054	98.59919
chr12	30801537	30801883	61.268505	67	35.126755	86.900986
chr12	30823382	30823667	48.13954	31	30.108646	15.040555
chr12	30906737	30907055	61.268505	71	50.18108	50.13518
chr12	3169678	3169941	52.51586	41	35.126755	28.409937
chr12	32044615	32044898	21.881609	79	65.235405	70.189255
chr12	32049738	32050103	301.96622	240	286.03214	330.8922
chr12	40207592	40208056	140.0423	166	235.85107	197.19838
chr12	40765710	40766018	52.51586	38	35.126755	25.06759
chr12	41065450	41065756	26.25793	32	30.108646	16.711727
chr12	43907683	43907989	26.25793	38	15.054323	21.725246
chr12	45887225	45887621	91.902756	90	75.27162	68.51808
chr12	45952422	45952824	100.6554	105	65.235405	86.900986
chr12	46785126	46785511	61.268505	45	30.108646	28.409937
chr12	47913060	47913617	144.41862	161	255.92351	133.69382
chr12	48268928	48269266	13.128965	27	55.19919	38.436974
chr12	48325178	48325579	175.05287	153	125.4527	185.50017
chr12	49080617	49080886	17.505287	32	25.09054	18.3829

chr12	49321630	49321936	56.89218	66	50.18108	80.21629
chr12	49537424	49537716	35.010574	47	20.072432	41.77932
chr12	49581753	49582170	91.902756	65	160.57945	101.941536
chr12	49697630	49697913	26.25793	55	40.144863	48.46401
chr12	49701704	49702106	144.41862	86	105.380264	101.941536
chr12	50202757	50203038	30.634253	56	25.09054	11.698209
chr12	51477251	51477576	100.6554	73	105.380264	58.491047
chr12	51989856	51990330	52.51586	84	35.126755	71.86043
chr12	5199618	5199880	61.268505	43	20.072432	46.792835
chr12	52489177	52489417	17.505287	32	10.036216	21.725246
chr12	52960494	52960934	39.386894	33	35.126755	31.752281
chr12	52965986	52966317	8.752644	36	40.144863	30.08111
chr12	52975658	52976189	275.70828	271	356.28568	344.2616
chr12	52984379	52984835	258.20297	137	165.59756	127.009125
chr12	53246862	53247145	56.89218	53	45.16297	23.396418
chr12	54635397	54635757	52.51586	45	100.36216	56.819874
chr12	54923950	54924245	35.010574	30	35.126755	36.7658
chr12	55719077	55719470	39.386894	49	35.126755	71.86043
chr12	5592025	5592385	70.02115	83	110.39838	100.27036
chr12	56232342	56232666	78.77379	61	95.34405	25.06759
chr12	570531	571339	306.34253	329	351.26755	312.5093
chr12	59610265	59610533	13.128965	33	10.036216	31.752281
chr12	60809364	60809674	35.010574	38	15.054323	16.711727
chr12	60941034	60941456	87.526436	109	70.25351	111.968575
chr12	63806051	63806448	144.41862	214	125.4527	180.48665
chr12	64540705	64541087	140.0423	125	45.16297	113.63975

chr12	6744673	6744905		17.505287	60	5.018108	80.21629
chr12	67546016	67546304		78.77379	93	105.380264	95.25684
chr12	67753150	67753408		30.634253	32	35.126755	13.369382
chr12	68288222	68288483		4.376322	38	5.018108	23.396418
chr12	68303966	68304409		201.3108	234	255.92351	200.54073
chr12	68340257	68340643		223.19241	140	195.7062	118.65327
chr12	6923282	6923762		91.902756	49	25.09054	73.5316
chr12	6944079	6944376		26.25793	41	25.09054	45.121662
chr12	6994548	6994859		13.128965	28	20.072432	31.752281
chr12	7252022	7252496		105.03172	125	115.41648	128.6803
chr12	789673	789914		78.77379	45	50.18108	40.108147
chr12	8125196	8125527	YES qPCR	70.02115	76	10.036216	8.355864
chr12	85821064	85821427		87.526436	80	25.09054	31.752281
chr12	8825223	8825497		13.128965	39	15.054323	18.3829
chr12	88311461	88311837		52.51586	50	55.19919	61.833393
chr12	883567	883980		61.268505	61	65.235405	51.806355
chr12	88458440	88458855		74.39747	78	50.18108	108.62623
chr12	88582041	88582294		87.526436	29	50.18108	36.7658
chr12	88717264	88717608		91.902756	80	70.25351	61.833393
chr12	890860	891180		140.0423	66	85.30783	66.84691
chr12	91321648	91321992		70.02115	120	50.18108	61.833393
chr12	92033082	92033415		39.386894	43	30.108646	38.436974
chr12	92233990	92234292		4.376322	52	25.09054	55.1487
chr12	92291053	92291393		83.150116	79	60.217293	90.243324
chr12	92419978	92420228		13.128965	45	55.19919	26.738764
chr12	93872115	93872460		74.39747	60	55.19919	56.819874

chr12	94018212	94018536	26.25793	56	10.036216	35.094627
chr12	94464375	94464692	39.386894	29	10.036216	31.752281
chr12	95378339	95378577	26.25793	47	10.036216	25.06759
chr12	95390321	95390565	21.881609	40	20.072432	11.698209
chr12	97357976	97358293	52.51586	32	100.36216	26.738764
chr12	9808632	9809032	166.30023	120	100.36216	110.2974
chr13	101006036	101006359	52.51586	51	70.25351	73.5316
chr13	101063128	101063435	126.91333	86	125.4527	155.41907
chr13	104887304	104887604	17.505287	40	15.054323	21.725246
chr13	112403471	112403762	21.881609	53	30.108646	43.450493
chr13	114006096	114006557	105.03172	142	100.36216	147.0632
chr13	114103718	114104000	56.89218	34	35.126755	20.054073
chr13	19678814	19679099	35.010574	34	10.036216	25.06759
chr13	20467673	20468067	140.0423	133	105.380264	125.33795
chr13	23042222	23042504	48.13954	38	20.072432	13.369382
chr13	23332046	23332340	39.386894	92	70.25351	90.243324
chr13	26191836	26192090	21.881609	32	25.09054	18.3829
chr13	26293874	26294125	26.25793	28	10.036216	31.752281
chr13	26455178	26455475	131.28966	111	135.4889	145.39203
chr13	26644318	26644616	65.64483	38	75.27162	36.7658
chr13	27880710	27881009	100.6554	67	45.16297	40.108147
chr13	28047018	28047406	131.28966	130	75.27162	101.941536
chr13	28222640	28222915	4.376322	31	35.126755	31.752281
chr13	28856670	28856962	56.89218	37	15.054323	20.054073
chr13	29054311	29054610	26.25793	41	15.054323	46.792835
chr13	29701184	29701468	13.128965	32	20.072432	23.396418

chr13	29968303	29968708		21.881609	49	65.235405	38.436974
chr13	31647440	31647825		52.51586	91	60.217293	100.27036
chr13	32686398	32686807		157.54758	123	260.94162	158.76141
chr13	32695130	32695429		26.25793	31	45.16297	26.738764
chr13	34821865	34822192		30.634253	37	15.054323	18.3829
chr13	36590224	36590487		48.13954	26	45.16297	36.7658
chr13	40144495	40144845		61.268505	48	65.235405	40.108147
chr13	40153535	40153968		39.386894	36	105.380264	23.396418
chr13	40263042	40263319		30.634253	19	35.126755	31.752281
chr13	40479127	40479429		52.51586	81	40.144863	61.833393
chr13	40935975	40936523		118.16069	187	70.25351	168.78845
chr13	40937755	40938115		8.752644	34	25.09054	31.752281
chr13	41468093	41468389	YES qPCR	52.51586	48	10.036216	13.369382
chr13	41494029	41494354	YES qPCR	48.13954	63	0	8.355864
chr13	43859094	43859438		30.634253	69	60.217293	53.477528
chr13	43870009	43870425		91.902756	110	70.25351	100.27036
chr13	44250976	44251290		74.39747	66	60.217293	26.738764
chr13	45572636	45572923		21.881609	45	30.108646	11.698209
chr13	45655787	45656051		39.386894	41	10.036216	38.436974
chr13	45683332	45683636		30.634253	14	25.09054	43.450493
chr13	48202040	48202436		135.66597	96	135.4889	100.27036
chr13	49318744	49319033		35.010574	50	25.09054	58.491047
chr13	49486593	49486875		91.902756	39	105.380264	30.08111
chr13	50072146	50072448		26.25793	32	30.108646	21.725246
chr13	72361648	72362010		17.505287	64	35.126755	65.175735
chr13	72937175	72937544		48.13954	98	55.19919	93.58567

chr13	72937643	72938017		26.25793	34	30.108646	30.08111
chr13	86327722	86328041		39.386894	42	30.108646	45.121662
chr13	86329096	86329354		30.634253	31	30.108646	35.094627
chr13	88154783	88155191		61.268505	97	65.235405	93.58567
chr13	94112598	94112942		39.386894	54	40.144863	60.16222
chr13	94735965	94736393		131.28966	172	190.6881	213.91011
chr13	96777833	96778176		144.41862	184	160.57945	155.41907
chr13	97673189	97673494		17.505287	52	25.09054	35.094627
chr13	98247051	98247321	YES	39.386894	52	5.018108	18.3829
chr13	98503883	98504309		118.16069	72	95.34405	58.491047
chr13	98652713	98653058		100.6554	53	35.126755	53.477528
chr14	101630203	101630534		26.25793	25	30.108646	41.77932
chr14	102040347	102040782		78.77379	95	110.39838	91.9145
chr14	102536584	102536988		65.64483	123	70.25351	106.955055
chr14	102850650	102850993		56.89218	107	25.09054	78.54512
chr14	102865026	102865429		61.268505	40	50.18108	25.06759
chr14	102879648	102879938		56.89218	89	100.36216	91.9145
chr14	102914249	102914551		26.25793	107	45.16297	113.63975
chr14	102930444	102930759		39.386894	52	60.217293	38.436974
chr14	103266762	103267129		96.27908	172	135.4889	190.51369
chr14	103479813	103480162		17.505287	31	20.072432	41.77932
chr14	103686330	103686581		21.881609	35	15.054323	28.409937
chr14	103694893	103695360		153.17126	137	240.86917	157.09024
chr14	104232433	104232722		35.010574	41	40.144863	15.040555
chr14	104238069	104238410		56.89218	60	45.16297	36.7658
chr14	105382821	105383144		74.39747	67	100.36216	96.92802



chr14	20014820	20015156		13.128965	40	30.108646	23.396418
chr14	20015570	20015948		83.150116	81	85.30783	68.51808
chr14	20020406	20020756		56.89218	53	50.18108	41.77932
chr14	22436365	22436829		153.17126	161	190.6881	160.43259
chr14	22636808	22637324		161.9239	138	135.4889	148.73438
chr14	22651749	22652147		140.0423	140	95.34405	106.955055
chr14	22659709	22659977		8.752644	39	35.126755	11.698209
chr14	23662390	23662797		87.526436	74	65.235405	43.450493
chr14	23699975	23700277		61.268505	42	45.16297	23.396418
chr14	23705692	23705927		52.51586	30	70.25351	50.13518
chr14	23795214	23795846		126.91333	105	105.380264	86.900986
chr14	23813353	23813637		26.25793	43	30.108646	35.094627
chr14	23973075	23973407		52.51586	56	25.09054	30.08111
chr14	24227024	24227379		140.0423	117	130.47081	116.98209
chr14	24523978	24524264		21.881609	39	35.126755	23.396418
chr14	29184110	29184474		17.505287	51	25.09054	25.06759
chr14	30191002	30191399		105.03172	73	110.39838	101.941536
chr14	30598503	30598894		166.30023	180	165.59756	217.25246
chr14	34412308	34412653		91.902756	93	125.4527	128.6803
chr14	49879107	49879465		65.64483	116	100.36216	95.25684
chr14	49880550	49880909		39.386894	83	40.144863	80.21629
chr14	50463463	50463694	YES	35.010574	31	5.018108	8.355864
chr14	51398770	51399361		227.56873	192	205.74242	163.77493
chr14	52523967	52524283		21.881609	69	50.18108	96.92802
chr14	52685390	52685643		35.010574	40	20.072432	30.08111
chr14	54467684	54468021		109.40804	84	75.27162	76.87395

chr14	54634808	54635089	35.010574	24	20.072432	31.752281
chr14	54659070	54659422	43.763218	45	25.09054	21.725246
chr14	54869145	54869469	30.634253	83	35.126755	88.57216
chr14	54907411	54907752	153.17126	142	75.27162	152.07672
chr14	54920354	54920656	39.386894	138	60.217293	138.70734
chr14	58102382	58102710	43.763218	37	60.217293	13.369382
chr14	58718294	58718580	39.386894	31	55.19919	53.477528
chr14	58724184	58724615	48.13954	87	70.25351	80.21629
chr14	61008516	61008838	21.881609	51	50.18108	70.189255
chr14	63816653	63817048	48.13954	49	25.09054	31.752281
chr14	64298570	64299152	35.010574	35	40.144863	33.423454
chr14	64378222	64378590	74.39747	104	125.4527	100.27036
chr14	64381414	64381872	210.06345	198	130.47081	203.88307
chr14	64417001	64417263	48.13954	42	70.25351	30.08111
chr14	64579541	64579856	39.386894	69	45.16297	86.900986
chr14	64580998	64581440	56.89218	112	50.18108	120.32444
chr14	66955379	66955730	166.30023	133	150.54324	132.02264
chr14	67172924	67173312	52.51586	89	130.47081	160.43259
chr14	67831640	67832258	266.95563	206	255.92351	207.22542
chr14	68081459	68081774	43.763218	49	85.30783	60.16222
chr14	68333756	68334070	52.51586	33	20.072432	16.711727
chr14	69162660	69162950	13.128965	42	25.09054	41.77932
chr14	69238352	69238725	74.39747	120	50.18108	105.28388
chr14	69291001	69291332	74.39747	73	65.235405	80.21629
chr14	72016919	72017238	65.64483	50	95.34405	86.900986
chr14	72359790	72360048	39.386894	39	10.036216	31.752281

chr14	72406080	72406454	26.25793	46	75.27162	23.396418
chr14	73277928	73278344	161.9239	99	160.57945	98.59919
chr14	73290005	73290262	91.902756	73	75.27162	68.51808
chr14	73308512	73308751	74.39747	33	55.19919	18.3829
chr14	73397644	73397895	61.268505	59	45.16297	41.77932
chr14	74246906	74247288	91.902756	128	120.434586	147.0632
chr14	74886914	74887398	52.51586	112	85.30783	110.2974
chr14	75369005	75369382	87.526436	64	60.217293	65.175735
chr14	75471056	75471337	48.13954	31	60.217293	13.369382
chr14	76251175	76251465	56.89218	56	90.32594	41.77932
chr14	76304548	76304894	17.505287	44	40.144863	51.806355
chr14	76576459	76576806	87.526436	55	70.25351	76.87395
chr14	76716927	76717218	35.010574	37	50.18108	20.054073
chr14	77361938	77362633	157.54758	218	180.65189	223.93715
chr14	77855573	77855816	26.25793	25	25.09054	33.423454
chr14	77856368	77856724	126.91333	136	155.56134	155.41907
chr14	77976334	77976834	91.902756	76	120.434586	105.28388
chr14	80604345	80604604	43.763218	27	50.18108	36.7658
chr14	88701561	88701931	196.93448	115	110.39838	110.2974
chr14	89005316	89005749	166.30023	105	120.434586	83.55864
chr14	89030105	89030463	96.27908	95	75.27162	98.59919
chr14	89838724	89838963	8.752644	37	10.036216	38.436974
chr14	90109880	90110241	74.39747	55	30.108646	43.450493
chr14	90256558	90256854	105.03172	69	120.434586	88.57216
chr14	90868470	90868867	118.16069	163	200.72432	158.76141
chr14	90907600	90907985	56.89218	66	70.25351	50.13518

chr14	92056510	92056829	70.02115	54	40.144863	56.819874
chr14	93284678	93285033	91.902756	87	100.36216	70.189255
chr14	94722268	94722501	52.51586	42	25.09054	35.094627
chr14	95059331	95059659	17.505287	39	40.144863	16.711727
chr14	95069410	95069737	56.89218	38	55.19919	50.13518
chr14	95080693	95081226	87.526436	70	60.217293	71.86043
chr14	96453448	96453856	56.89218	71	95.34405	81.88747
chr14	97734438	97734725	56.89218	39	50.18108	23.396418
chr14	99678676	99679006	148.79494	95	120.434586	68.51808
chr15	29057866	29058107	39.386894	139	60.217293	155.41907
chr15	29079231	29079669	26.25793	51	35.126755	40.108147
chr15	29335910	29336471	240.6977	254	286.03214	329.22104
chr15	29345478	29345926	214.43977	129	291.05026	103.61271
chr15	29404297	29404711	52.51586	79	55.19919	51.806355
chr15	29445153	29445589	56.89218	61	90.32594	48.46401
chr15	29642551	29642862	21.881609	34	20.072432	20.054073
chr15	31341863	31342209	26.25793	43	40.144863	56.819874
chr15	31521951	31522321	43.763218	54	35.126755	58.491047
chr15	33246234	33246607	140.0423	97	105.380264	93.58567
chr15	33636996	33637328	39.386894	29	60.217293	56.819874
chr15	36403415	36403738	91.902756	63	40.144863	40.108147
chr15	37219405	37220051	266.95563	250	160.57945	252.34708
chr15	37976742	37977104	192.55817	123	185.67	195.5272
chr15	38506727	38507064	100.6554	88	45.16297	90.243324
chr15	38638862	38639275	161.9239	147	80.28973	103.61271
chr15	38825155	38825567	113.78436	127	85.30783	95.25684

	chr15	41184628	41184981		17.505287	35	20.072432	43.450493
	chr15	41264232	41264505		21.881609	34	5.018108	30.08111
EPB42 promoter	chr15	41300322	41301035		437.63217	320	406.46674	394.39676
	chr15	43248770	43249122	YES	74.39747	50	5.018108	38.436974
	chr15	43497094	43497384		26.25793	34	40.144863	26.738764
	chr15	46659725	46660148		70.02115	102	100.36216	65.175735
	chr15	47764791	47765173	YES	13.128965	29	60.217293	68.51808
	chr15	48135248	48135506		21.881609	38	5.018108	30.08111
	chr15	48340476	48340882		52.51586	55	85.30783	21.725246
	chr15	49785881	49786184		21.881609	47	55.19919	28.409937
	chr15	49958347	49958651		52.51586	46	15.054323	40.108147
	chr15	57190821	57191142		21.881609	50	25.09054	53.477528
	chr15	58694733	58695228		30.634253	60	115.41648	66.84691
	chr15	60532811	60533212		39.386894	41	40.144863	73.5316
	chr15	60563213	60563548		17.505287	43	45.16297	25.06759
	chr15	61153121	61153378		13.128965	36	20.072432	21.725246
	chr15	61271631	61271881		52.51586	56	45.16297	21.725246
	chr15	61913468	61913844		249.45035	90	291.05026	105.28388
	chr15	62217620	62217908		13.128965	32	20.072432	48.46401
	chr15	62284466	62284710		52.51586	25	30.108646	43.450493
	chr15	62296293	62296709		52.51586	54	90.32594	45.121662
	chr15	62312624	62312886		17.505287	52	15.054323	40.108147
	chr15	62518297	62518660		48.13954	36	75.27162	15.040555
	chr15	62774866	62775137		17.505287	32	55.19919	25.06759
	chr15	63375541	63375912		48.13954	52	30.108646	20.054073
	chr15	63384168	63384402		26.25793	41	15.054323	18.3829

chr15	63630592	63630932	4.376322	46	45.16297	40.108147
chr15	63884372	63884868	214.43977	140	225.81485	180.48665
chr15	64759009	64759416	70.02115	86	60.217293	50.13518
chr15	65130769	65131074	43.763218	47	40.144863	23.396418
chr15	65170596	65170957	61.268505	41	55.19919	38.436974
chr15	65177761	65178021	21.881609	44	45.16297	3.3423455
chr15	67062592	67062938	17.505287	58	45.16297	65.175735
chr15	67193994	67194420	113.78436	91	75.27162	50.13518
chr15	67681570	67681911	8.752644	73	30.108646	78.54512
chr15	67694932	67695382	70.02115	114	130.47081	123.66679
chr15	68527365	68527696	78.77379	32	90.32594	35.094627
chr15	70311576	70311912	26.25793	49	65.235405	51.806355
chr15	71275634	71275957	21.881609	39	15.054323	18.3829
chr15	72071053	72071344	26.25793	32	50.18108	36.7658
chr15	72468996	72469400	214.43977	145	225.81485	188.84251
chr15	72499646	72500092	105.03172	91	140.50702	113.63975
chr15	72689682	72690277	455.13745	399	401.44864	521.4059
chr15	72947053	72947302	48.13954	29	80.28973	48.46401
chr15	73033795	73034265	266.95563	138	220.79675	162.10376
chr15	73102719	73103031	78.77379	38	30.108646	21.725246
chr15	73686107	73686558	100.6554	121	80.28973	121.99561
chr15	73773667	73774261	65.64483	71	70.25351	38.436974
chr15	74368991	74369305	65.64483	49	65.235405	55.1487
chr15	76327394	76327688	126.91333	159	120.434586	160.43259
chr15	76342708	76343103	78.77379	84	105.380264	70.189255
chr15	76356062	76356357	56.89218	43	70.25351	45.121662

chr15	76775332	76775636		26.25793	41	35.126755	18.3829
chr15	79178498	79178859		96.27908	78	75.27162	56.819874
chr15	81315318	81315692		122.53701	144	155.56134	142.04968
chr15	82961657	82961909		135.66597	110	115.41648	162.10376
chr15	83926956	83927330		131.28966	151	40.144863	118.65327
chr15	86972357	86972805		196.93448	115	135.4889	168.78845
chr15	86983029	86983388		13.128965	34	35.126755	30.08111
chr15	87570916	87571273		91.902756	60	125.4527	65.175735
chr15	88444548	88444846		21.881609	46	10.036216	41.77932
chr15	88487440	88487935		153.17126	112	110.39838	91.9145
chr15	88534089	88534403		21.881609	18	25.09054	35.094627
chr15	89185231	89185501		48.13954	84	65.235405	100.27036
chr15	89348742	89349150		74.39747	104	90.32594	86.900986
chr15	89822821	89823206		245.07402	176	250.9054	225.60832
chr15	90961806	90962173		30.634253	34	20.072432	30.08111
chr15	91222690	91223323		140.0423	86	140.50702	100.27036
chr15	91799869	91800133	YES qPCR	30.634253	32	5.018108	1.6711727
chr15	92287887	92288122		21.881609	55	5.018108	33.423454
chr15	94054288	94054590	YES	26.25793	31	5.018108	5.0135183
chr15	96304586	96304936		48.13954	51	100.36216	35.094627
chr15	96337475	96337870	YES qPCR	8.752644	25	55.19919	61.833393
chr15	97080148	97080442		21.881609	25	5.018108	40.108147
chr15	97137701	97137981		35.010574	26	60.217293	63.504562
chr15	99613360	99613721		39.386894	38	15.054323	53.477528
chr15	99809031	99809500		78.77379	77	55.19919	83.55864
chr15	99859408	99859720		43.763218	32	55.19919	23.396418

HS-40 Alpha-Globin MC	chr16	103290	103957	293.21356	362	336.21323	419.46436
	chr16	10973637	10974036	56.89218	86	35.126755	73.5316
HS-33 Alpha-Globin MCS	chr16	109787	110385	144.41862	100	95.34405	85.22981
	chr16	11103480	11103803	43.763218	61	90.32594	31.752281
	chr16	11106452	11106737	26.25793	55	55.19919	28.409937
	chr16	11735476	11735770	17.505287	33	5.018108	25.06759
HS-10 Alpha-Globin MCS	chr16	132962	133361	122.53701	109	120.434586	127.009125
	chr16	14502818	14503093	52.51586	32	55.19919	28.409937
	chr16	15522883	15523864	315.09515	348	341.23132	396.06793
	chr16	15606388	15606995	196.93448	144	150.54324	140.37851
	chr16	16121658	16122321	56.89218	101	95.34405	93.58567
	chr16	164470	164764	65.64483	60	55.19919	73.5316
	chr16	1647253	1647609	30.634253	43	40.144863	55.1487
	chr16	165054	165545	39.386894	26	65.235405	46.792835
	chr16	1810643	1810912	21.881609	37	5.018108	20.054073
	chr16	1822706	1823240	135.66597	194	105.380264	185.50017
	chr16	19439633	19439919	48.13954	68	35.126755	61.833393
	chr16	1944605	1944910	65.64483	44	115.41648	33.423454
	chr16	19558817	19559125	17.505287	31	55.19919	23.396418
	chr16	21180318	21180703	109.40804	125	155.56134	142.04968
	chr16	21427927	21428176	87.526436	138	115.41648	180.48665
	chr16	21444176	21444611	43.763218	60	65.235405	100.27036
	chr16	21530650	21531033	100.6554	109	85.30783	113.63975
	chr16	21562690	21562952	35.010574	59	45.16297	71.86043
	chr16	22135079	22135429	56.89218	63	40.144863	41.77932
	chr16	23586094	23586391	17.505287	48	10.036216	15.040555



chr16	24035236	24035520	30.634253	49	70.25351	31.752281
chr16	24054571	24054914	35.010574	76	45.16297	68.51808
chr16	24136301	24136640	65.64483	44	10.036216	31.752281
chr16	2469480	2469842	113.78436	133	85.30783	148.73438
chr16	25135616	25135944	21.881609	71	50.18108	45.121662
chr16	28844529	28844819	26.25793	41	55.19919	15.040555
chr16	28928202	28928475	78.77379	49	65.235405	50.13518
chr16	29521116	29521461	253.82666	156	205.74242	192.18486
chr16	29573811	29574041	43.763218	33	80.28973	40.108147
chr16	29582189	29582519	56.89218	39	85.30783	35.094627
chr16	30492208	30492492	70.02115	50	65.235405	36.7658
chr16	30685487	30685920	83.150116	92	110.39838	65.175735
chr16	30996794	30997199	91.902756	64	80.28973	70.189255
chr16	31428069	31428379	4.376322	35	15.054323	38.436974
chr16	314457	314840	21.881609	33	40.144863	28.409937
chr16	31446409	31446908	188.18184	164	150.54324	188.84251
chr16	33830649	33831165	52.51586	61	25.09054	20.054073
chr16	33841753	33842165	21.881609	48	5.018108	20.054073
chr16	3464230	3464582	61.268505	66	55.19919	51.806355
chr16	3836670	3836973	26.25793	59	35.126755	60.16222
chr16	4816603	4816861	48.13954	52	50.18108	56.819874
chr16	4823990	4824302	74.39747	87	50.18108	121.99561
chr16	48289655	48290175	223.19241	129	326.177	162.10376
chr16	48662509	48662860	78.77379	85	80.28973	95.25684
chr16	48854797	48855186	61.268505	67	70.25351	48.46401
chr16	54898671	54898964	39.386894	31	20.072432	26.738764

chr16	54910791	54911161	30.634253	44	25.09054	43.450493
chr16	55212590	55212880	35.010574	46	25.09054	40.108147
chr16	55356278	55356564	43.763218	46	30.108646	26.738764
chr16	558626	558885	65.64483	26	90.32594	43.450493
chr16	56220993	56221341	61.268505	44	110.39838	40.108147
chr16	56281353	56281640	56.89218	73	55.19919	51.806355
chr16	56567852	56568197	61.268505	58	105.380264	93.58567
chr16	57003770	57004036	21.881609	31	25.09054	23.396418
chr16	57008935	57009350	113.78436	48	50.18108	35.094627
chr16	57025566	57025846	35.010574	53	35.126755	48.46401
chr16	57383624	57384013	78.77379	72	105.380264	91.9145
chr16	57451434	57451735	35.010574	55	30.108646	51.806355
chr16	57605426	57605676	78.77379	33	40.144863	20.054073
chr16	65785617	65786172	144.41862	90	170.61566	110.2974
chr16	66051684	66051971	26.25793	38	25.09054	21.725246
chr16	66351550	66352410	271.33194	274	326.177	275.7435
chr16	66372545	66372944	83.150116	63	75.27162	76.87395
chr16	66391785	66392303	70.02115	69	65.235405	81.88747
chr16	67363509	67363851	161.9239	211	180.65189	238.9777
chr16	68099745	68100165	153.17126	179	240.86917	220.5948
chr16	68988013	68988294	21.881609	38	40.144863	46.792835
chr16	69019594	69019881	35.010574	33	20.072432	28.409937
chr16	69287069	69287560	52.51586	151	55.19919	157.09024
chr16	69343830	69344129	17.505287	44	40.144863	46.792835
chr16	70318888	70319271	74.39747	132	90.32594	111.968575
chr16	70605295	70605618	35.010574	36	20.072432	40.108147

chr16	71629073	71629588		113.78436	82	110.39838	80.21629
chr16	73494579	73494881	YES qPCR	8.752644	9	40.144863	50.13518
chr16	73534659	73535032		87.526436	73	85.30783	86.900986
chr16	73634477	73634903		109.40804	157	145.52513	155.41907
chr16	73679022	73679328		21.881609	34	35.126755	20.054073
chr16	74100916	74101156		21.881609	51	35.126755	18.3829
chr16	74212471	74212761		21.881609	35	10.036216	25.06759
chr16	74292502	74292849		43.763218	37	30.108646	56.819874
chr16	76562802	76563169		43.763218	34	25.09054	26.738764
chr16	76569095	76569561		43.763218	91	40.144863	31.752281
chr16	77211320	77211563		39.386894	43	35.126755	36.7658
chr16	77211606	77212071		65.64483	99	80.28973	88.57216
chr16	77701703	77701993		30.634253	53	10.036216	38.436974
chr16	80277442	80277930		140.0423	165	150.54324	167.11728
chr16	8172732	8173114		201.3108	167	205.74242	153.7479
chr16	84065981	84066241		35.010574	24	30.108646	33.423454
chr16	84126564	84126927		96.27908	55	90.32594	56.819874
chr16	84145214	84145600		96.27908	103	125.4527	132.02264
chr16	84208000	84208309		26.25793	34	40.144863	20.054073
chr16	84265191	84265713		153.17126	164	130.47081	155.41907
chr16	8595649	8595983		83.150116	74	160.57945	130.35147
chr16	86445520	86445961		258.20297	152	421.52106	177.14432
chr16	86449210	86449592		109.40804	120	125.4527	158.76141
chr16	8648028	8648407		70.02115	86	55.19919	101.941536
chr16	87052313	87052681		109.40804	94	100.36216	137.03616
chr16	87085510	87085978		166.30023	98	260.94162	83.55864

	chr16	87105858	87106170	105.03172	54	110.39838	58.491047
	chr16	87117798	87118117	74.39747	35	55.19919	46.792835
	chr16	87282045	87282410	56.89218	61	60.217293	60.16222
	chr16	87393894	87394191	39.386894	43	60.217293	38.436974
	chr16	87586281	87586722	126.91333	72	170.61566	85.22981
	chr16	87597984	87598427	428.87955	258	496.7927	295.79758
	chr16	87684158	87684484	26.25793	35	75.27162	66.84691
	chr16	87692406	87692746	70.02115	83	70.25351	91.9145
	chr16	88312925	88313378	78.77379	89	95.34405	81.88747
	chr16	8963066	8963330	39.386894	40	50.18108	35.094627
HS-48 Alpha-Globin MCS	chr16	94867	95418	109.40804	149	115.41648	175.47314
	chr17	12862235	12862539	17.505287	47	20.072432	31.752281
	chr17	13354144	13354548	83.150116	145	90.32594	162.10376
	chr17	1499877	1500150	30.634253	54	50.18108	35.094627
	chr17	15076495	15076880	26.25793	66	70.25351	30.08111
	chr17	15334721	15335078	74.39747	56	40.144863	66.84691
	chr17	1580352	1580669	105.03172	65	70.25351	73.5316
	chr17	16225071	16225308	8.752644	31	30.108646	15.040555
	chr17	16932111	16932534	52.51586	63	55.19919	81.88747
	chr17	17072363	17072708	21.881609	48	45.16297	38.436974
	chr17	17148467	17148730	43.763218	67	35.126755	65.175735
	chr17	19114896	19115357	258.20297	176	270.9778	232.29301
	chr17	19854081	19854500	113.78436	195	165.59756	200.54073
	chr17	20051263	20051518	61.268505	42	50.18108	36.7658
	chr17	21115666	21115957	13.128965	34	20.072432	43.450493
	chr17	21116843	21117214	126.91333	129	95.34405	157.09024

chr17	21138429	21138730	96.27908	128	95.34405	172.1308
chr17	21139219	21139615	70.02115	36	90.32594	35.094627
chr17	22825226	22825577	105.03172	123	135.4889	103.61271
chr17	22925113	22925640	13.128965	42	35.126755	38.436974
chr17	22931063	22931335	43.763218	37	25.09054	45.121662
chr17	22953827	22954140	26.25793	36	10.036216	31.752281
chr17	23271731	23272062	13.128965	37	25.09054	23.396418
chr17	23279756	23280034	30.634253	33	45.16297	23.396418
chr17	23319211	23319749	126.91333	189	170.61566	132.02264
chr17	23337939	23338357	91.902756	81	80.28973	73.5316
chr17	23478350	23478739	65.64483	93	70.25351	105.28388
chr17	23524225	23524524	26.25793	31	30.108646	26.738764
chr17	23878356	23878851	91.902756	187	175.63377	163.77493
chr17	24208964	24209424	43.763218	30	65.235405	40.108147
chr17	24209427	24209841	30.634253	22	55.19919	50.13518
chr17	24209854	24210538	91.902756	45	95.34405	80.21629
chr17	24211545	24211924	105.03172	68	50.18108	30.08111
chr17	24212669	24213288	227.56873	107	95.34405	70.189255
chr17	24216290	24216891	266.95563	239	225.81485	257.3606
chr17	24223900	24224326	118.16069	124	140.50702	123.66679
chr17	24231435	24231716	21.881609	31	45.16297	23.396418
chr17	26922065	26922355	48.13954	59	30.108646	36.7658
chr17	27488012	27488443	70.02115	44	50.18108	56.819874
chr17	27494128	27494419	65.64483	37	70.25351	46.792835
chr17	28248532	28248982	109.40804	116	35.126755	130.35147
chr17	29222725	29223394	43.763218	33	95.34405	61.833393

chr17	29225730	29226217	65.64483	64	170.61566	133.69382
chr17	29255674	29255975	17.505287	35	15.054323	53.477528
chr17	29256440	29256889	161.9239	141	180.65189	227.2795
chr17	30236134	30236577	39.386894	71	80.28973	30.08111
chr17	30416116	30416396	39.386894	44	65.235405	41.77932
chr17	30911895	30912226	205.68712	182	155.56134	197.19838
chr17	31912468	31912756	43.763218	52	45.16297	20.054073
chr17	32031011	32031335	4.376322	31	55.19919	21.725246
chr17	32158996	32159308	65.64483	59	60.217293	23.396418
chr17	33159448	33159782	52.51586	30	50.18108	41.77932
chr17	33870045	33870467	39.386894	59	25.09054	81.88747
chr17	34825950	34826366	192.55817	115	130.47081	133.69382
chr17	3490289	3490646	83.150116	46	110.39838	45.121662
chr17	34939286	34939557	26.25793	35	25.09054	30.08111
chr17	35093351	35093632	74.39747	54	85.30783	50.13518
chr17	35329061	35329370	8.752644	30	25.09054	31.752281
chr17	35739707	35740011	39.386894	29	25.09054	40.108147
chr17	35740230	35740706	87.526436	101	95.34405	110.2974
chr17	36910433	36910715	13.128965	36	10.036216	20.054073
chr17	37347858	37348290	210.06345	162	200.72432	187.17134
chr17	37348384	37348809	48.13954	53	50.18108	48.46401
chr17	37725401	37725850	100.6554	133	105.380264	155.41907
chr17	37864984	37865292	43.763218	41	50.18108	56.819874
chr17	37924069	37924396	83.150116	37	50.18108	70.189255
chr17	38023372	38023750	87.526436	78	55.19919	81.88747
chr17	38029655	38030084	43.763218	88	55.19919	83.55864

chr17	38035122	38035630	205.68712	167	130.47081	155.41907
chr17	38038559	38038913	48.13954	51	70.25351	40.108147
chr17	38104608	38104971	61.268505	108	120.434586	81.88747
chr17	38748684	38749104	74.39747	44	35.126755	36.7658
chr17	38793811	38794353	126.91333	136	55.19919	170.45963
chr17	39680419	39681472	170.67654	55	185.67	83.55864
chr17	39699466	39699849	240.6977	221	291.05026	302.48227
chr17	39700895	39701396	113.78436	62	90.32594	63.504562
chr17	39714451	39714801	196.93448	178	255.92351	249.00475
chr17	39716343	39716716	78.77379	46	75.27162	51.806355
chr17	39721237	39721490	65.64483	75	50.18108	83.55864
chr17	39822759	39823066	21.881609	39	45.16297	31.752281
chr17	39826177	39826517	26.25793	57	60.217293	50.13518
chr17	40568540	40568942	61.268505	45	95.34405	81.88747
chr17	40710533	40710809	17.505287	32	30.108646	33.423454
chr17	4099565	4099916	100.6554	117	75.27162	105.28388
chr17	42621772	42622155	170.67654	118	165.59756	160.43259
chr17	42724049	42724349	21.881609	35	60.217293	26.738764
chr17	43242925	43243271	21.881609	34	75.27162	55.1487
chr17	43368332	43368706	26.25793	38	40.144863	21.725246
chr17	43888227	43888505	43.763218	41	50.18108	45.121662
chr17	43921088	43921426	118.16069	74	130.47081	81.88747
chr17	44681557	44682059	166.30023	125	210.76053	125.33795
chr17	451503	451920	166.30023	161	155.56134	167.11728
chr17	45171931	45172622	258.20297	306	235.85107	299.13992
chr17	45193305	45193623	8.752644	43	35.126755	26.738764

chr17	45199202	45199650	105.03172	87	110.39838	123.66679
chr17	45211747	45212124	87.526436	66	55.19919	51.806355
chr17	45586102	45586473	52.51586	53	70.25351	46.792835
chr17	50293527	50293790	56.89218	55	45.16297	35.094627
chr17	50816742	50816981	17.505287	44	10.036216	38.436974
chr17	50872764	50873175	223.19241	133	180.65189	162.10376
chr17	51249215	51249520	21.881609	26	25.09054	33.423454
chr17	5252277	5252592	30.634253	80	25.09054	38.436974
chr17	52853020	52853446	52.51586	65	45.16297	60.16222
chr17	53761896	53762493	91.902756	48	80.28973	38.436974
chr17	53924920	53925368	109.40804	150	95.34405	162.10376
chr17	55070064	55070363	91.902756	113	80.28973	91.9145
chr17	55117194	55117447	65.64483	48	40.144863	36.7658
chr17	55794051	55794491	266.95563	214	270.9778	242.32005
chr17	55820918	55821221	17.505287	57	20.072432	60.16222
chr17	56577047	56577343	48.13954	53	25.09054	45.121662
chr17	58124029	58124378	65.64483	56	70.25351	58.491047
chr17	58812139	58812591	87.526436	126	105.380264	143.72086
chr17	58851650	58852031	35.010574	39	15.054323	46.792835
chr17	58863000	58863333	35.010574	49	55.19919	41.77932
chr17	59201395	59201736	21.881609	33	40.144863	33.423454
chr17	59437813	59438127	13.128965	43	10.036216	35.094627
chr17	59455341	59455624	30.634253	43	35.126755	46.792835
chr17	59595662	59596086	35.010574	46	35.126755	46.792835
chr17	59645191	59645604	201.3108	163	185.67	173.80197
chr17	59964113	59964383	35.010574	33	35.126755	21.725246



chr17	60349608	60349854	87.526436	96	80.28973	103.61271
chr17	60401350	60401685	26.25793	40	50.18108	33.423454
chr17	60599993	60600350	39.386894	87	25.09054	123.66679
chr17	62584755	62585030	8.752644	34	40.144863	16.711727
chr17	68736474	68737067	166.30023	135	115.41648	145.39203
chr17	68982141	68982465	148.79494	96	145.52513	121.99561
chr17	70632064	70632357	43.763218	32	50.18108	31.752281
chr17	70956205	70956494	35.010574	36	20.072432	15.040555
chr17	71143240	71143703	96.27908	72	135.4889	80.21629
chr17	7127041	7127394	91.902756	74	55.19919	85.22981
chr17	71287257	71287608	56.89218	30	70.25351	36.7658
chr17	71356944	71357422	105.03172	98	110.39838	148.73438
chr17	71483904	71484208	48.13954	35	35.126755	23.396418
chr17	71542175	71542521	87.526436	53	50.18108	48.46401
chr17	71862581	71862903	43.763218	46	50.18108	46.792835
chr17	71913640	71913913	83.150116	48	80.28973	41.77932
chr17	71922246	71922560	39.386894	46	55.19919	38.436974
chr17	72224312	72224585	91.902756	43	120.434586	45.121662
chr17	72356333	72356726	56.89218	87	60.217293	75.202774
chr17	72578238	72578574	91.902756	102	155.56134	96.92802
chr17	72579201	72579489	56.89218	38	25.09054	28.409937
chr17	72580357	72580669	30.634253	42	45.16297	50.13518
chr17	72630260	72630592	131.28966	167	155.56134	252.34708
chr17	72728689	72728928	65.64483	75	45.16297	81.88747
chr17	73049725	73050053	21.881609	58	45.16297	40.108147
chr17	73079120	73079640	358.8584	248	381.3762	322.53635

chr17	7328295	7328614	43.763218	20	85.30783	40.108147
chr17	73432690	73433174	109.40804	188	160.57945	232.29301
chr17	73637837	73638125	21.881609	33	70.25351	28.409937
chr17	73653828	73654134	122.53701	41	80.28973	36.7658
chr17	7429682	7430087	70.02115	114	95.34405	113.63975
chr17	7494592	7495126	96.27908	53	175.63377	36.7658
chr17	8017129	8017515	74.39747	64	35.126755	75.202774
chr17	8280673	8280982	30.634253	46	30.108646	55.1487
chr17	8472795	8473145	39.386894	53	25.09054	38.436974
chr17	8553100	8553458	65.64483	92	65.235405	70.189255
chr18	10236229	10236494	35.010574	30	40.144863	33.423454
chr18	12481931	12482258	48.13954	44	15.054323	58.491047
chr18	13299710	13300018	26.25793	32	70.25351	30.08111
chr18	13300361	13300630	35.010574	31	10.036216	25.06759
chr18	13512301	13512670	39.386894	45	80.28973	41.77932
chr18	13574833	13575145	21.881609	32	40.144863	40.108147
chr18	138912	139168	61.268505	98	50.18108	78.54512
chr18	19214798	19215119	39.386894	64	45.16297	60.16222
chr18	22089794	22090114	21.881609	34	10.036216	25.06759
chr18	22101340	22101702	30.634253	38	20.072432	25.06759
chr18	2844025	2844518	78.77379	102	65.235405	66.84691
chr18	2960235	2960471	26.25793	26	15.054323	31.752281
chr18	2972819	2973192	70.02115	90	35.126755	100.27036
chr18	32034350	32034647	96.27908	39	100.36216	31.752281
chr18	3237059	3237344	65.64483	38	80.28973	26.738764
chr18	32552917	32553367	65.64483	77	55.19919	85.22981

chr18	32647770	32648025		48.13954	33	10.036216	31.752281
chr18	33104070	33104303		35.010574	30	45.16297	31.752281
chr18	3642682	3643285		113.78436	123	110.39838	133.69382
chr18	3696475	3696834		70.02115	82	60.217293	100.27036
chr18	3906113	3906577		65.64483	183	100.36216	190.51369
chr18	41297092	41297335		26.25793	14	25.09054	33.423454
chr18	41298696	41298999		35.010574	27	30.108646	40.108147
chr18	41504236	41504502		26.25793	34	5.018108	50.13518
chr18	41520803	41521037	YES	30.634253	34	5.018108	3.3423455
chr18	41556900	41557203		170.67654	117	215.77864	163.77493
chr18	41558063	41558371		56.89218	74	40.144863	91.9145
chr18	41773198	41773562		56.89218	66	45.16297	53.477528
chr18	41987212	41987609		249.45035	146	185.67	85.22981
chr18	42463409	42463696		30.634253	28	25.09054	38.436974
chr18	42545437	42545741		39.386894	27	80.28973	58.491047
chr18	44561707	44561998		17.505287	35	10.036216	31.752281
chr18	44852968	44853319		96.27908	81	65.235405	105.28388
chr18	49978162	49978462		43.763218	82	50.18108	95.25684
chr18	50689519	50689860		52.51586	51	65.235405	41.77932
chr18	50691478	50691762		35.010574	44	30.108646	28.409937
chr18	52450309	52450585		4.376322	54	20.072432	46.792835
chr18	52869726	52870161		118.16069	68	95.34405	65.175735
chr18	53406500	53406886		175.05287	116	135.4889	116.98209
chr18	53477785	53478148		39.386894	96	25.09054	93.58567
chr18	53485065	53485437		39.386894	66	30.108646	63.504562
chr18	53486250	53486532		21.881609	31	5.018108	18.3829

chr18	53874170	53874470	43.763218	36	45.16297	28.409937
chr18	53936318	53936594	30.634253	65	75.27162	80.21629
chr18	58268681	58269048	70.02115	108	85.30783	101.941536
chr18	58269246	58269607	26.25793	31	15.054323	33.423454
chr18	58843983	58844253	13.128965	53	25.09054	23.396418
chr18	607958	608406	78.77379	61	45.16297	40.108147
chr18	66196545	66196803	21.881609	33	25.09054	65.175735
chr18	66266866	66267144	70.02115	49	90.32594	56.819874
chr18	66439988	66440257	8.752644	33	20.072432	23.396418
chr18	70060678	70061164	56.89218	92	85.30783	70.189255
chr18	70155789	70156076	39.386894	38	40.144863	23.396418
chr18	75088727	75089009	13.128965	25	25.09054	33.423454
chr18	75120247	75120596	17.505287	51	10.036216	38.436974
chr18	75367996	75368380	87.526436	61	90.32594	90.243324
chr18	75805855	75806207	4.376322	18	145.52513	118.65327
chr18	75836110	75836410	8.752644	36	10.036216	33.423454
chr18	8810420	8810769	17.505287	36	35.126755	33.423454
chr18	8838275	8838589	56.89218	35	95.34405	21.725246
chr18	9792547	9792851	48.13954	42	40.144863	21.725246
chr18	9793432	9793909	245.07402	212	245.88728	250.6759
chr19	10271205	10271578	61.268505	33	75.27162	30.08111
chr19	10515246	10515538	385.11633	41	411.48483	43.450493
chr19	10649418	10649764	43.763218	51	70.25351	55.1487
chr19	10781410	10781694	35.010574	32	60.217293	40.108147
chr19	10870841	10871388	157.54758	171	115.41648	152.07672
chr19	1158529	1159300	520.7823	151	657.37213	172.1308

	chr19	12756262	12756768	83.150116	208	65.235405	227.2795
PRDX2 intron 3	chr19	12772051	12772392	39.386894	45	30.108646	55.1487
	chr19	12804267	12804539	35.010574	15	85.30783	40.108147
	chr19	12857938	12858418	126.91333	67	155.56134	90.243324
KLF intron 1	chr19	12858704	12859170	43.763218	42	50.18108	20.054073
KLF1 promoter	chr19	12859248	12859664	223.19241	140	270.9778	180.48665
	chr19	12919586	12920072	131.28966	98	35.126755	115.31092
	chr19	13041357	13041879	157.54758	173	205.74242	198.86955
	chr19	13049099	13049561	135.66597	141	75.27162	167.11728
	chr19	13074416	13074840	853.38275	43	1129.0742	65.175735
	chr19	13869129	13869421	43.763218	113	35.126755	115.31092
	chr19	15265022	15265428	109.40804	127	85.30783	128.6803
	chr19	15266386	15266800	87.526436	57	85.30783	58.491047
	chr19	15374257	15374641	39.386894	55	35.126755	88.57216
	chr19	16050721	16051092	56.89218	83	40.144863	83.55864
	chr19	16287878	16288113	43.763218	68	80.28973	41.77932
	chr19	17253295	17253743	131.28966	68	135.4889	45.121662
	chr19	1787790	1788153	56.89218	65	45.16297	45.121662
	chr19	17971376	17971729	245.07402	203	255.92351	270.72998
	chr19	18062936	18063322	61.268505	44	70.25351	55.1487
	chr19	18128890	18129214	140.0423	52	205.74242	75.202774
	chr19	1823451	1823689	56.89218	39	55.19919	38.436974
	chr19	18345636	18345878	118.16069	106	140.50702	132.02264
	chr19	18515870	18516142	205.68712	175	195.7062	203.88307
	chr19	19031963	19032291	183.80551	117	160.57945	155.41907
	chr19	19389656	19389955	96.27908	61	20.072432	6.684691

chr19	2214646	2214903	100.6554	54	75.27162	60.16222
chr19	2690117	2690418	30.634253	60	45.16297	66.84691
chr19	3454008	3454362	65.64483	65	75.27162	73.5316
chr19	34996451	34996702	21.881609	28	80.28973	45.121662
chr19	40563227	40563471	21.881609	31	20.072432	31.752281
chr19	4081639	4082131	87.526436	83	100.36216	66.84691
chr19	41283264	41283496	30.634253	30	20.072432	38.436974
chr19	4325997	4326275	26.25793	20	35.126755	43.450493
chr19	4326700	4327099	65.64483	68	65.235405	101.941536
chr19	43335515	43335808	48.13954	44	30.108646	28.409937
chr19	43452502	43452861	91.902756	137	120.434586	115.31092
chr19	43453125	43453459	26.25793	33	45.16297	26.738764
chr19	43499569	43499959	87.526436	98	110.39838	127.009125
chr19	43726580	43726921	52.51586	35	20.072432	21.725246
chr19	43847389	43847678	48.13954	38	30.108646	23.396418
chr19	43858718	43859022	35.010574	33	35.126755	26.738764
chr19	44517650	44517953	65.64483	54	105.380264	51.806355
chr19	45662352	45662846	214.43977	172	326.177	227.2795
chr19	45864191	45864456	17.505287	34	35.126755	43.450493
chr19	47425373	47425755	118.16069	77	115.41648	90.243324
chr19	48970426	48970740	341.3531	38	436.57538	41.77932
chr19	4957264	4957522	65.64483	44	40.144863	61.833393
chr19	50106205	50106526	126.91333	97	135.4889	115.31092
chr19	5042063	5042333	74.39747	30	65.235405	48.46401
chr19	50549350	50549770	105.03172	90	70.25351	128.6803
chr19	506970	507310	100.6554	68	115.41648	60.16222

chr19	51824851	51825216	52.51586	48	30.108646	43.450493
chr19	51981321	51981796	118.16069	125	90.32594	123.66679
chr19	52424149	52424552	13.128965	26	10.036216	33.423454
chr19	52439158	52439441	301.96622	20	381.3762	36.7658
chr19	525671	526049	210.06345	136	220.79675	197.19838
chr19	52692317	52692804	78.77379	54	35.126755	41.77932
chr19	53960932	53961174	13.128965	39	10.036216	48.46401
chr19	54062209	54062488	17.505287	32	25.09054	35.094627
chr19	54068554	54068986	183.80551	146	225.81485	157.09024
chr19	54172805	54173153	61.268505	60	70.25351	71.86043
chr19	54970853	54971207	78.77379	103	100.36216	93.58567
chr19	55182296	55182628	43.763218	35	55.19919	33.423454
chr19	5536920	5537257	74.39747	36	75.27162	28.409937
chr19	55572581	55572891	52.51586	62	65.235405	73.5316
chr19	56703276	56703582	126.91333	79	105.380264	98.59919
chr19	5750296	5750683	201.3108	62	286.03214	86.900986
chr19	5845462	5845804	52.51586	59	50.18108	68.51808
chr19	59403939	59404188	48.13954	31	25.09054	20.054073
chr19	60431851	60432268	148.79494	134	135.4889	155.41907
chr19	61329018	61329377	52.51586	93	45.16297	93.58567
chr19	6141314	6141619	35.010574	43	45.16297	50.13518
chr19	61466539	61466875	87.526436	63	95.34405	45.121662
chr19	61524346	61524847	131.28966	173	145.52513	205.55424
chr19	62639579	62639920	26.25793	33	55.19919	6.684691
chr19	6375868	6376202	43.763218	45	50.18108	20.054073
chr19	7475635	7475871	39.386894	49	30.108646	43.450493

chr19	7650299	7650731		74.39747	48	110.39838	81.88747
chr19	8388969	8389381		354.48206	197	301.0865	212.23894
chr19	858200	858501		210.06345	73	170.61566	83.55864
chr19	895202	895461		30.634253	24	35.126755	41.77932
chr19	969409	969715		26.25793	49	25.09054	51.806355
chr19	991976	992474		140.0423	105	200.72432	86.900986
chr2	10018583	10018920		153.17126	140	105.380264	157.09024
chr2	100266689	100266961		21.881609	32	35.126755	51.806355
chr2	100274159	100274428		30.634253	35	35.126755	41.77932
chr2	101665245	101665595		74.39747	78	55.19919	73.5316
chr2	102052095	102052576		310.71884	197	311.12268	223.93715
chr2	10427358	10427816		122.53701	128	140.50702	165.4461
chr2	105363644	105363920		26.25793	41	10.036216	35.094627
chr2	105368764	105369148		74.39747	112	55.19919	116.98209
chr2	105400992	105401386		52.51586	49	45.16297	35.094627
chr2	106191846	106192100		56.89218	43	50.18108	50.13518
chr2	111659681	111660092		26.25793	35	45.16297	23.396418
chr2	112392551	112392809		21.881609	37	40.144863	23.396418
chr2	112529299	112529563		65.64483	34	80.28973	45.121662
chr2	113157903	113158296		48.13954	101	80.28973	110.2974
chr2	113160609	113160915		21.881609	33	30.108646	20.054073
chr2	11445356	11445601		52.51586	46	45.16297	66.84691
chr2	118426206	118426534		43.763218	73	50.18108	58.491047
chr2	118427263	118427589		122.53701	92	55.19919	71.86043
chr2	119649638	119649869	YES qPCR	26.25793	46	0	0
chr2	12025546	12026036		144.41862	122	160.57945	152.07672



chr2	122004843	122005362	78.77379	80	80.28973	70.189255
chr2	122070443	122070767	78.77379	79	75.27162	70.189255
chr2	122609562	122609927	48.13954	64	130.47081	56.819874
chr2	122660945	122661311	39.386894	43	35.126755	51.806355
chr2	122667714	122668009	52.51586	30	95.34405	43.450493
chr2	124265871	124266215	39.386894	41	60.217293	81.88747
chr2	126055660	126055940	43.763218	37	20.072432	10.027037
chr2	127135794	127136311	179.4292	175	200.72432	192.18486
chr2	127148018	127148477	271.33194	180	245.88728	202.2119
chr2	127150747	127151171	70.02115	66	50.18108	60.16222
chr2	128502702	128503032	39.386894	34	45.16297	50.13518
chr2	128566847	128567138	83.150116	67	60.217293	81.88747
chr2	136613788	136614097	65.64483	32	15.054323	15.040555
chr2	138438530	138438927	61.268505	169	40.144863	155.41907
chr2	138493363	138493650	13.128965	49	20.072432	45.121662
chr2	143622049	143622481	91.902756	64	90.32594	73.5316
chr2	144704604	144705098	43.763218	52	60.217293	60.16222
chr2	144915704	144916144	83.150116	80	75.27162	36.7658
chr2	145056594	145057278	183.80551	233	140.50702	227.2795
chr2	148636920	148637252	118.16069	125	135.4889	83.55864
chr2	148925110	148925430	43.763218	39	55.19919	21.725246
chr2	150150904	150151192	52.51586	40	40.144863	70.189255
chr2	152339843	152340167	39.386894	31	15.054323	41.77932
chr2	153137889	153138211	61.268505	54	55.19919	63.504562
chr2	15490496	15490746	35.010574	36	10.036216	28.409937
chr2	15613894	15614234	122.53701	92	60.217293	75.202774

chr2	157126875	157127260	100.6554	103	30.108646	98.59919
chr2	157826070	157826453	105.03172	111	90.32594	121.99561
chr2	157889057	157889468	39.386894	60	20.072432	78.54512
chr2	15816475	15816855	74.39747	64	40.144863	60.16222
chr2	158351602	158351922	48.13954	46	25.09054	55.1487
chr2	159616918	159617185	30.634253	30	30.108646	31.752281
chr2	159700285	159700584	4.376322	47	5.018108	21.725246
chr2	159711955	159712347	153.17126	157	150.54324	150.40555
chr2	160970269	160970639	48.13954	52	50.18108	68.51808
chr2	16458065	16458406	26.25793	38	45.16297	21.725246
chr2	169338855	169339263	87.526436	70	75.27162	76.87395
chr2	169540903	169541287	13.128965	57	85.30783	58.491047
chr2	169576961	169577253	52.51586	66	30.108646	53.477528
chr2	169637391	169637663	13.128965	32	15.054323	23.396418
chr2	170578651	170578971	183.80551	134	150.54324	153.7479
chr2	171385690	171385997	35.010574	68	45.16297	60.16222
chr2	171387718	171388139	183.80551	62	240.86917	88.57216
chr2	172621700	172621977	105.03172	73	55.19919	71.86043
chr2	172670694	172671057	131.28966	97	75.27162	76.87395
chr2	174647766	174648133	87.526436	72	95.34405	55.1487
chr2	17638545	17638896	35.010574	71	45.16297	30.08111
chr2	177837950	177838282	30.634253	40	40.144863	13.369382
chr2	178212606	178212857	39.386894	35	50.18108	30.08111
chr2	17836350	17836677	30.634253	28	55.19919	50.13518
chr2	178846641	178847062	109.40804	94	160.57945	75.202774
chr2	181940478	181940765	35.010574	32	40.144863	20.054073

chr2	182019853	182020228	21.881609	64	40.144863	46.792835
chr2	182030884	182031177	21.881609	37	30.108646	51.806355
chr2	182033961	182034413	61.268505	108	90.32594	121.99561
chr2	182337087	182337422	65.64483	85	25.09054	55.1487
chr2	190154816	190155239	109.40804	102	145.52513	73.5316
chr2	190186067	190186444	26.25793	32	20.072432	25.06759
chr2	190757417	190757846	122.53701	112	60.217293	123.66679
chr2	191032946	191033260	13.128965	59	15.054323	65.175735
chr2	191596377	191596646	52.51586	39	15.054323	36.7658
chr2	192170247	192170529	21.881609	44	55.19919	56.819874
chr2	196060005	196060341	39.386894	44	45.16297	33.423454
chr2	196086120	196086542	83.150116	119	70.25351	138.70734
chr2	196139365	196139722	170.67654	111	130.47081	91.9145
chr2	196743187	196743487	21.881609	42	30.108646	31.752281
chr2	196750108	196750473	118.16069	100	85.30783	98.59919
chr2	198019862	198020138	26.25793	75	25.09054	83.55864
chr2	201535797	201536068	30.634253	28	40.144863	40.108147
chr2	201726412	201726694	30.634253	20	25.09054	31.752281
chr2	202006470	202006815	144.41862	129	115.41648	110.2974
chr2	202013149	202013538	87.526436	160	185.67	157.09024
chr2	202474749	202475136	91.902756	140	75.27162	145.39203
chr2	202960630	202960937	13.128965	34	30.108646	30.08111
chr2	203920292	203920706	83.150116	156	50.18108	185.50017
chr2	205597970	205598350	26.25793	38	50.18108	36.7658
chr2	206288829	206289177	48.13954	54	130.47081	81.88747
chr2	206353660	206354024	26.25793	76	25.09054	76.87395

chr2	20642510	20642849	91.902756	62	40.144863	55.1487
chr2	208338602	208338904	83.150116	59	105.380264	68.51808
chr2	208635065	208635375	17.505287	30	45.16297	36.7658
chr2	208951940	208952253	8.752644	40	20.072432	25.06759
chr2	209144747	209145159	87.526436	43	120.434586	38.436974
chr2	21304962	21305231	61.268505	52	50.18108	58.491047
chr2	216761485	216761830	48.13954	55	40.144863	35.094627
chr2	217342076	217342455	48.13954	41	105.380264	36.7658
chr2	217509929	217510234	17.505287	34	30.108646	30.08111
chr2	217665713	217666077	148.79494	112	135.4889	208.89659
chr2	218400728	218401043	87.526436	53	115.41648	78.54512
chr2	218859803	218860125	74.39747	63	50.18108	68.51808
chr2	218860714	218861122	245.07402	170	225.81485	178.81548
chr2	218995370	218995746	8.752644	83	70.25351	100.27036
chr2	219745942	219746257	91.902756	47	65.235405	73.5316
chr2	219790742	219791180	175.05287	128	190.6881	150.40555
chr2	219852459	219852765	503.277	60	657.37213	71.86043
chr2	220082990	220083440	83.150116	98	100.36216	90.243324
chr2	221993321	221993641	65.64483	32	70.25351	31.752281
chr2	224966134	224966487	21.881609	52	25.09054	30.08111
chr2	227408231	227408667	166.30023	122	200.72432	120.32444
chr2	227410736	227411158	65.64483	81	45.16297	73.5316
chr2	228024210	228024670	56.89218	91	50.18108	53.477528
chr2	230583475	230583765	30.634253	39	5.018108	25.06759
chr2	231808102	231808602	201.3108	190	260.94162	187.17134
chr2	232252236	232252471	30.634253	26	30.108646	31.752281

chr2	234025393	234025711		61.268505	85	55.19919	66.84691
chr2	234431159	234431497		26.25793	31	20.072432	26.738764
chr2	236034139	236034378	YES qPCR	0	5	15.054323	41.77932
chr2	236646762	236647020		17.505287	17	25.09054	60.16222
chr2	238538338	238538808		253.82666	215	311.12268	247.33357
chr2	238741835	238742297		48.13954	75	55.19919	66.84691
chr2	23880554	23880833		39.386894	60	45.16297	28.409937
chr2	238994819	238995169		39.386894	67	25.09054	56.819874
chr2	238995581	238995986		140.0423	127	150.54324	138.70734
chr2	239853851	239854121		8.752644	35	15.054323	25.06759
chr2	24087728	24088044		170.67654	138	245.88728	137.03616
chr2	241153785	241154149		91.902756	81	125.4527	76.87395
chr2	242077866	242078273		17.505287	69	35.126755	76.87395
chr2	242289355	242289614		17.505287	16	45.16297	35.094627
chr2	25299230	25299525		100.6554	73	110.39838	83.55864
chr2	26268065	26268437		135.66597	73	80.28973	76.87395
chr2	26350534	26350798		13.128965	31	30.108646	21.725246
chr2	27132875	27133139		17.505287	31	10.036216	26.738764
chr2	27139245	27139538		17.505287	41	25.09054	63.504562
chr2	27517608	27517939		87.526436	58	60.217293	61.833393
chr2	2829163	2829448		43.763218	38	70.25351	31.752281
chr2	29190238	29190471		48.13954	44	15.054323	15.040555
chr2	30255452	30255854		52.51586	89	70.25351	132.02264
chr2	30268157	30268436		61.268505	95	110.39838	81.88747
chr2	30329340	30329792		70.02115	87	105.380264	106.955055
chr2	30366990	30367514		345.72943	290	265.95972	349.27512

chr2	32244316	32244622	52.51586	46	70.25351	30.08111
chr2	32846998	32847317	56.89218	110	45.16297	103.61271
chr2	32972709	32972997	52.51586	42	85.30783	43.450493
chr2	33028571	33028845	17.505287	34	20.072432	46.792835
chr2	33187142	33187607	48.13954	127	55.19919	138.70734
chr2	33197270	33197604	65.64483	36	10.036216	28.409937
chr2	33201306	33201692	148.79494	96	80.28973	118.65327
chr2	38000409	38000742	48.13954	46	40.144863	30.08111
chr2	38444920	38445213	65.64483	106	50.18108	110.2974
chr2	38694452	38694783	43.763218	34	35.126755	25.06759
chr2	42440654	42440960	13.128965	34	35.126755	38.436974
chr2	43086266	43086498	17.505287	26	45.16297	36.7658
chr2	43233712	43234002	17.505287	37	50.18108	60.16222
chr2	43258763	43259005	43.763218	51	25.09054	55.1487
chr2	43271207	43271612	175.05287	131	120.434586	121.99561
chr2	43309161	43309407	39.386894	39	30.108646	21.725246
chr2	43501251	43501573	21.881609	35	35.126755	26.738764
chr2	43975473	43975761	43.763218	39	50.18108	41.77932
chr2	47417630	47417933	13.128965	35	20.072432	18.3829
chr2	48281317	48281808	48.13954	92	50.18108	100.27036
chr2	48345750	48346148	65.64483	80	75.27162	71.86043
chr2	53749143	53749567	144.41862	142	70.25351	167.11728
chr2	53835693	53836026	26.25793	37	25.09054	25.06759
chr2	53850844	53851136	26.25793	32	20.072432	25.06759
chr2	54158006	54158380	65.64483	105	55.19919	128.6803
chr2	54670257	54670497	13.128965	25	30.108646	36.7658

chr2	55221134	55221510	105.03172	93	80.28973	121.99561
chr2	57857606	57857956	56.89218	39	70.25351	31.752281
chr2	58128676	58128910	26.25793	34	30.108646	45.121662
chr2	58838643	58838927	43.763218	34	30.108646	35.094627
chr2	59114813	59115154	26.25793	28	45.16297	35.094627
chr2	60575840	60576160	39.386894	33	25.09054	28.409937
chr2	60578701	60579218	100.6554	101	80.28973	93.58567
chr2	62257394	62257718	61.268505	121	65.235405	113.63975
chr2	62258352	62258597	4.376322	24	25.09054	31.752281
chr2	62376738	62377107	105.03172	157	120.434586	162.10376
chr2	63047591	63047940	43.763218	51	40.144863	35.094627
chr2	63077490	63077789	30.634253	60	25.09054	35.094627
chr2	64729580	64730084	83.150116	94	15.054323	58.491047
chr2	65102340	65102746	21.881609	48	35.126755	53.477528
chr2	68073935	68074338	48.13954	72	25.09054	45.121662
chr2	68201678	68202062	126.91333	126	140.50702	116.98209
chr2	68207076	68207336	8.752644	23	25.09054	31.752281
chr2	68216187	68216541	43.763218	77	10.036216	71.86043
chr2	68238123	68238434	21.881609	40	40.144863	30.08111
chr2	6943645	6943915	35.010574	38	10.036216	25.06759
chr2	6945243	6945607	26.25793	56	55.19919	60.16222
chr2	6951360	6951884	157.54758	281	225.81485	300.8111
chr2	6967359	6967684	35.010574	32	25.09054	23.396418
chr2	70798173	70798734	148.79494	134	160.57945	93.58567
chr2	7082675	7082922	26.25793	21	45.16297	31.752281
chr2	71686832	71687179	61.268505	87	70.25351	142.04968

chr2	71963628	71964084	43.763218	44	40.144863	50.13518
chr2	72624166	72624591	91.902756	94	35.126755	68.51808
chr2	74051528	74051813	83.150116	91	80.28973	125.33795
chr2	74107028	74107348	56.89218	59	35.126755	50.13518
chr2	74111918	74112303	35.010574	43	25.09054	36.7658
chr2	74113274	74113783	118.16069	68	115.41648	61.833393
chr2	74158313	74158611	65.64483	39	40.144863	25.06759
chr2	74164405	74164815	30.634253	63	30.108646	51.806355
chr2	74611017	74611539	91.902756	100	95.34405	108.62623
chr2	75391459	75391717	26.25793	36	15.054323	23.396418
chr2	75392650	75393052	105.03172	90	95.34405	101.941536
chr2	8061827	8062223	126.91333	60	130.47081	88.57216
chr2	84031874	84032259	52.51586	67	75.27162	73.5316
chr2	84052238	84052538	56.89218	39	80.28973	31.752281
chr2	85580705	85581103	118.16069	123	150.54324	150.40555
chr2	86074638	86074922	52.51586	41	35.126755	38.436974
chr2	86270095	86270421	87.526436	92	90.32594	133.69382
chr2	86294786	86295125	52.51586	56	20.072432	86.900986
chr2	86540201	86540614	56.89218	57	75.27162	63.504562
chr2	8673310	8673770	65.64483	156	75.27162	145.39203
chr2	87569743	87569977	13.128965	57	15.054323	50.13518
chr2	8951842	8952233	48.13954	56	40.144863	71.86043
chr2	8985115	8985436	70.02115	44	55.19919	53.477528
chr2	96527561	96528013	210.06345	190	215.77864	172.1308
chr2	98455226	98455533	65.64483	47	60.217293	23.396418
chr2	98491188	98491565	21.881609	37	40.144863	26.738764



chr2	98717765	98718104	43.763218	65	50.18108	11.698209
chr20	10426934	10427219	43.763218	42	25.09054	35.094627
chr20	1050097	1050391	26.25793	54	25.09054	35.094627
chr20	1051236	1051561	56.89218	46	90.32594	31.752281
chr20	1140792	1141070	83.150116	39	115.41648	28.409937
chr20	1636742	1637093	65.64483	46	55.19919	50.13518
chr20	20875002	20875382	43.763218	61	90.32594	56.819874
chr20	23061655	23062068	144.41862	100	90.32594	91.9145
chr20	23062136	23062550	65.64483	64	60.217293	23.396418
chr20	23122447	23122885	118.16069	108	120.434586	142.04968
chr20	23240565	23240940	43.763218	41	35.126755	43.450493
chr20	24928872	24929126	26.25793	48	10.036216	33.423454
chr20	28251992	28252445	13.128965	40	25.09054	21.725246
chr20	29658811	29659072	13.128965	40	15.054323	38.436974
chr20	29662173	29662452	61.268505	33	35.126755	20.054073
chr20	29722188	29722586	65.64483	64	75.27162	63.504562
chr20	29726661	29727162	35.010574	45	45.16297	43.450493
chr20	29727253	29727693	192.55817	154	235.85107	167.11728
chr20	30001772	30002030	35.010574	41	25.09054	15.040555
chr20	30258595	30258836	35.010574	35	55.19919	18.3829
chr20	30337218	30337530	26.25793	80	30.108646	83.55864
chr20	30591236	30591558	48.13954	32	30.108646	30.08111
chr20	31740378	31740645	65.64483	76	50.18108	41.77932
chr20	32062898	32063131	13.128965	32	45.16297	31.752281
chr20	32764869	32765197	74.39747	56	90.32594	68.51808
chr20	33565780	33566152	52.51586	63	45.16297	25.06759

chr20	35588218	35588491	21.881609	30	25.09054	33.423454
chr20	35689256	35689575	21.881609	39	20.072432	26.738764
chr20	35895409	35895800	52.51586	68	55.19919	33.423454
chr20	35912569	35912936	144.41862	92	165.59756	106.955055
chr20	36049235	36049545	105.03172	60	90.32594	20.054073
chr20	36221833	36222352	126.91333	154	125.4527	98.59919
chr20	36728419	36728751	65.64483	103	90.32594	98.59919
chr20	36754829	36755167	48.13954	34	35.126755	26.738764
chr20	3695611	3695910	30.634253	34	15.054323	20.054073
chr20	37009915	37010412	148.79494	162	180.65189	193.85603
chr20	3753689	3753943	17.505287	32	20.072432	28.409937
chr20	3771031	3771359	26.25793	35	30.108646	16.711727
chr20	3838625	3839106	109.40804	109	150.54324	105.28388
chr20	3859440	3859873	161.9239	177	160.57945	180.48665
chr20	39096346	39096691	91.902756	103	80.28973	83.55864
chr20	39112419	39113117	175.05287	178	160.57945	180.48665
chr20	39148548	39148821	4.376322	31	15.054323	15.040555
chr20	39487541	39487792	35.010574	47	60.217293	53.477528
chr20	4042938	4043226	74.39747	34	45.16297	30.08111
chr20	4083608	4084054	236.32138	171	240.86917	168.78845
chr20	4120953	4121322	61.268505	72	40.144863	56.819874
chr20	41380920	41381176	43.763218	112	55.19919	96.92802
chr20	41600632	41600966	39.386894	52	40.144863	76.87395
chr20	42072399	42072744	48.13954	129	70.25351	132.02264
chr20	42456802	42457177	105.03172	78	95.34405	83.55864
chr20	43405559	43405817	35.010574	32	40.144863	25.06759

chr20	45102826	45103227	78.77379	84	70.25351	83.55864
chr20	45422661	45423211	280.0846	189	200.72432	222.26598
chr20	46813087	46813338	26.25793	41	10.036216	20.054073
chr20	47750978	47751350	52.51586	55	35.126755	63.504562
chr20	47756530	47756795	21.881609	38	25.09054	11.698209
chr20	48215915	48216283	30.634253	34	20.072432	38.436974
chr20	48741098	48741562	538.2876	109	632.2816	165.4461
chr20	51225403	51225774	87.526436	109	80.28973	71.86043
chr20	51661319	51661717	78.77379	78	50.18108	66.84691
chr20	51663251	51663605	8.752644	52	20.072432	33.423454
chr20	51962296	51962720	105.03172	124	80.28973	128.6803
chr20	52094109	52094430	43.763218	48	25.09054	43.450493
chr20	52115599	52115931	179.4292	152	125.4527	163.77493
chr20	54371223	54371695	196.93448	192	230.83296	187.17134
chr20	54420604	54420984	100.6554	62	100.36216	75.202774
chr20	5533735	5534018	56.89218	41	65.235405	55.1487
chr20	55418490	55418909	293.21356	176	275.99594	210.56776
chr20	55423559	55424023	210.06345	152	230.83296	153.7479
chr20	5604096	5604390	131.28966	135	70.25351	150.40555
chr20	5665887	5666307	17.505287	32	20.072432	48.46401
chr20	5669800	5670142	56.89218	88	65.235405	75.202774
chr20	57029482	57029900	131.28966	140	110.39838	143.72086
chr20	5713430	5713812	258.20297	168	205.74242	173.80197
chr20	58210538	58210795	26.25793	43	30.108646	41.77932
chr20	60243616	60243878	91.902756	106	115.41648	81.88747
chr20	60283082	60283355	65.64483	55	25.09054	38.436974

RUNX1

chr20	60365770	60366100	100.6554	47	100.36216	45.121662
chr20	61867512	61868003	61.268505	60	125.4527	78.54512
chr20	6504442	6504774	65.64483	61	65.235405	66.84691
chr20	8642919	8643218	48.13954	41	105.380264	41.77932
chr21	14565244	14565674	48.13954	128	60.217293	133.69382
chr21	28686665	28686965	30.634253	28	70.25351	76.87395
chr21	28896807	28897125	35.010574	46	30.108646	50.13518
chr21	29936093	29936505	135.66597	110	130.47081	142.04968
chr21	32029922	32030203	21.881609	45	55.19919	60.16222
chr21	32475623	32476035	105.03172	157	165.59756	177.14432
chr21	33491840	33492200	52.51586	61	50.18108	58.491047
chr21	33805032	33805414	39.386894	61	10.036216	60.16222
chr21	34112231	34112534	74.39747	60	65.235405	68.51808
chr21	35320921	35321227	118.16069	43	90.32594	60.16222
chr21	35777429	35777716	65.64483	37	80.28973	26.738764
chr21	35842172	35842513	100.6554	80	110.39838	51.806355
chr21	36593311	36593693	48.13954	71	75.27162	80.21629
chr21	36614814	36615319	131.28966	84	85.30783	81.88747
chr21	37853090	37853321	8.752644	20	35.126755	38.436974
chr21	38770205	38770579	30.634253	37	60.217293	26.738764
chr21	39279387	39279896	175.05287	118	220.79675	137.03616
chr21	41503064	41503327	17.505287	36	20.072432	43.450493
chr21	42226130	42226509	61.268505	75	70.25351	78.54512
chr21	42389641	42389982	43.763218	84	45.16297	76.87395
chr21	42840218	42840666	52.51586	73	45.16297	63.504562
chr21	43512055	43512428	161.9239	136	130.47081	187.17134

chr21	45099093	45099567	236.32138	133	165.59756	125.33795	
chr21	45501335	45501608	30.634253	33	45.16297	20.054073	
chr21	45655786	45656198	179.4292	89	160.57945	86.900986	
chr22	16649310	16649648	43.763218	75	45.16297	65.175735	
chr22	16687295	16687799	122.53701	155	150.54324	155.41907	
chr22	16843353	16843659	70.02115	145	40.144863	197.19838	
chr22	17764481	17764917	105.03172	85	135.4889	113.63975	
chr22	17775670	17776141	43.763218	33	20.072432	51.806355	
chr22	17787241	17787534	39.386894	40	40.144863	28.409937	
chr22	18300123	18300595	65.64483	81	80.28973	96.92802	
chr22	18300852	18301413	245.07402	208	230.83296	237.30653	
chr22	18392893	18393360	301.96622	350	210.76053	367.658	
chr22	19601128	19601365	21.881609	28	10.036216	60.16222	
chr22	21759042	21759341	39.386894	40	30.108646	53.477528	
chr22	21779132	21779548	83.150116	122	90.32594	106.955055	
chr22	21896063	21896392	43.763218	41	45.16297	33.423454	
chr22	22356807	22357207	74.39747	125	110.39838	130.35147	
chr22	22643330	22643639	26.25793	38	40.144863	33.423454	
chr22	22665871	22666203	13.128965	38	15.054323	45.121662	
chr22	22718160	22718399	YES qPCR	0	0	30.108646	58.491047
chr22	22817759	22818058	39.386894	54	40.144863	30.08111	
chr22	23279652	23279997	61.268505	41	20.072432	35.094627	
chr22	23827015	23827344	35.010574	41	85.30783	36.7658	
chr22	23874390	23874691	13.128965	45	25.09054	26.738764	
chr22	25205525	25205770	39.386894	30	35.126755	36.7658	
chr22	25238344	25238665	56.89218	35	45.16297	35.094627	

chr22	25311131	25311461	39.386894	70	40.144863	10.027037
chr22	25322931	25323279	52.51586	47	40.144863	45.121662
chr22	25358561	25358870	17.505287	62	45.16297	58.491047
chr22	27822893	27823237	87.526436	58	110.39838	56.819874
chr22	27918544	27918843	35.010574	65	50.18108	68.51808
chr22	27928202	27928574	39.386894	76	70.25351	73.5316
chr22	28418129	28418467	17.505287	64	55.19919	53.477528
chr22	28459764	28460393	240.6977	254	286.03214	262.3741
chr22	28506884	28507285	70.02115	98	55.19919	111.968575
chr22	28557488	28557909	109.40804	131	135.4889	123.66679
chr22	28678129	28678569	56.89218	213	50.18108	220.5948
chr22	28942657	28943045	131.28966	204	110.39838	150.40555
chr22	29010258	29010610	56.89218	47	45.16297	50.13518
chr22	29088989	29089318	56.89218	68	60.217293	53.477528
chr22	29173697	29174206	148.79494	88	150.54324	83.55864
chr22	29232420	29232780	105.03172	153	75.27162	200.54073
chr22	29607501	29607853	56.89218	36	55.19919	43.450493
chr22	29608967	29609339	56.89218	43	80.28973	58.491047
chr22	30311184	30311549	35.010574	42	20.072432	35.094627
chr22	30352529	30352955	131.28966	144	135.4889	167.11728
chr22	30663353	30663788	96.27908	112	70.25351	100.27036
chr22	31298729	31298965	39.386894	41	75.27162	48.46401
chr22	31606976	31607610	83.150116	133	105.380264	110.2974
chr22	34468259	34468610	65.64483	49	55.19919	40.108147
chr22	35060379	35060671	48.13954	40	25.09054	35.094627
chr22	35094421	35094885	87.526436	112	30.108646	83.55864

chr22	35206155	35206407	21.881609	56	45.16297	65.175735
chr22	35627388	35627748	48.13954	46	15.054323	20.054073
chr22	35708191	35708498	231.94505	142	255.92351	178.81548
chr22	35968569	35968840	30.634253	31	10.036216	30.08111
chr22	36278613	36279013	201.3108	156	165.59756	198.86955
chr22	36529178	36529576	70.02115	106	55.19919	110.2974
chr22	37676860	37677206	30.634253	44	40.144863	91.9145
chr22	37691854	37692143	48.13954	28	70.25351	33.423454
chr22	38089703	38090152	83.150116	54	60.217293	26.738764
chr22	38178547	38178803	35.010574	55	55.19919	46.792835
chr22	38352239	38352546	87.526436	135	40.144863	193.85603
chr22	38558596	38558972	52.51586	62	65.235405	80.21629
chr22	38672540	38673024	170.67654	137	155.56134	150.40555
chr22	38687516	38687773	21.881609	28	25.09054	31.752281
chr22	38719983	38720376	65.64483	52	85.30783	66.84691
chr22	38916390	38916828	118.16069	242	125.4527	250.6759
chr22	38982021	38982350	30.634253	52	20.072432	35.094627
chr22	39278035	39278358	21.881609	36	60.217293	51.806355
chr22	39681599	39682019	192.55817	127	140.50702	157.09024
chr22	40329751	40330083	83.150116	69	105.380264	43.450493
chr22	40906274	40906634	39.386894	97	50.18108	75.202774
chr22	41341077	41341703	148.79494	124	100.36216	101.941536
chr22	41372823	41373201	87.526436	63	60.217293	63.504562
chr22	41648964	41649205	4.376322	33	5.018108	35.094627
chr22	41652141	41652451	30.634253	51	25.09054	40.108147
chr22	41733561	41733988	87.526436	95	75.27162	91.9145

chr22	41909511	41909792	35.010574	79	60.217293	68.51808
chr22	42773564	42774176	240.6977	197	265.95972	217.25246
chr22	43451215	43451707	170.67654	142	200.72432	157.09024
chr22	45014316	45014638	39.386894	28	35.126755	35.094627
chr22	45015890	45016326	105.03172	149	115.41648	150.40555
chr22	45577565	45577872	126.91333	44	180.65189	35.094627
chr22	48565694	48565944	13.128965	49	5.018108	50.13518
chr3	10123672	10123950	56.89218	44	75.27162	51.806355
chr3	101262699	101262984	30.634253	45	15.054323	13.369382
chr3	101556398	101556756	48.13954	73	50.18108	38.436974
chr3	10208752	10208985	35.010574	45	25.09054	23.396418
chr3	102527301	102527605	65.64483	54	60.217293	61.833393
chr3	103383671	103384034	52.51586	67	30.108646	51.806355
chr3	106815871	106816226	30.634253	57	20.072432	25.06759
chr3	108612664	108612943	48.13954	44	50.18108	36.7658
chr3	109207623	109208076	74.39747	45	95.34405	30.08111
chr3	109301526	109301851	39.386894	37	40.144863	26.738764
chr3	109305933	109306344	201.3108	129	135.4889	142.04968
chr3	109327100	109327593	87.526436	68	120.434586	53.477528
chr3	117241149	117241437	26.25793	28	35.126755	56.819874
chr3	120535346	120535671	56.89218	65	70.25351	65.175735
chr3	120619794	120620112	70.02115	55	35.126755	43.450493
chr3	126033204	126033582	52.51586	46	25.09054	23.396418
chr3	126078084	126078415	83.150116	63	45.16297	55.1487
chr3	128187568	128187836	21.881609	28	20.072432	43.450493
chr3	128612856	128613149	96.27908	45	75.27162	25.06759



chr3	128787533	128787890	35.010574	78	35.126755	81.88747
chr3	128902859	128903225	17.505287	26	15.054323	35.094627
chr3	128903704	128904005	65.64483	55	70.25351	56.819874
chr3	128908593	128908890	43.763218	49	60.217293	35.094627
chr3	12969683	12970181	192.55817	91	240.86917	95.25684
chr3	12971754	12972200	161.9239	114	210.76053	125.33795
chr3	130258359	130258638	52.51586	98	60.217293	110.2974
chr3	130561842	130562161	61.268505	34	60.217293	26.738764
chr3	130995445	130995872	65.64483	107	50.18108	66.84691
chr3	13421164	13421571	70.02115	121	70.25351	115.31092
chr3	134857751	134858031	17.505287	51	10.036216	43.450493
chr3	13501647	13501884	17.505287	54	55.19919	48.46401
chr3	135052950	135053260	74.39747	112	35.126755	110.2974
chr3	135093975	135094419	78.77379	91	60.217293	90.243324
chr3	137336613	137336910	61.268505	38	75.27162	36.7658
chr3	137452613	137452943	109.40804	84	85.30783	108.62623
chr3	139389519	139389840	48.13954	41	75.27162	45.121662
chr3	140423604	140423925	39.386894	83	80.28973	61.833393
chr3	14248967	14249492	166.30023	144	130.47081	153.7479
chr3	143223942	143224312	43.763218	145	40.144863	155.41907
chr3	143230731	143230974	13.128965	32	10.036216	50.13518
chr3	143247895	143248701	218.81609	229	185.67	212.23894
chr3	144135948	144136372	118.16069	110	90.32594	53.477528
chr3	144170204	144170533	8.752644	56	40.144863	41.77932
chr3	144178098	144178486	52.51586	74	25.09054	70.189255
chr3	144178967	144179202	48.13954	34	10.036216	23.396418

chr3	144484662	144485348	144.41862	175	160.57945	182.15782
chr3	144792259	144792537	39.386894	52	45.16297	26.738764
chr3	147697179	147697464	30.634253	36	25.09054	33.423454
chr3	150041023	150041354	21.881609	39	45.16297	41.77932
chr3	15069255	15069571	87.526436	49	35.126755	45.121662
chr3	151013522	151013763	17.505287	36	50.18108	31.752281
chr3	151933919	151934331	21.881609	50	40.144863	46.792835
chr3	151938879	151939209	144.41862	124	150.54324	178.81548
chr3	151941928	151942270	56.89218	36	35.126755	30.08111
chr3	152274754	152275080	56.89218	93	25.09054	71.86043
chr3	152336599	152336976	83.150116	102	65.235405	76.87395
chr3	153443803	153444084	131.28966	47	50.18108	55.1487
chr3	153520719	153521107	100.6554	154	105.380264	137.03616
chr3	154110051	154110282	91.902756	53	55.19919	36.7658
chr3	154176731	154177087	74.39747	117	75.27162	100.27036
chr3	154229823	154230234	100.6554	98	75.27162	130.35147
chr3	154281199	154281566	131.28966	93	75.27162	88.57216
chr3	15536816	15537119	61.268505	63	75.27162	58.491047
chr3	156380060	156380307	74.39747	33	40.144863	38.436974
chr3	156535372	156535649	17.505287	34	25.09054	26.738764
chr3	15769738	15769984	13.128965	45	20.072432	16.711727
chr3	15804565	15804901	83.150116	38	60.217293	35.094627
chr3	159360265	159360600	87.526436	101	70.25351	90.243324
chr3	159880024	159880303	52.51586	48	60.217293	33.423454
chr3	159913665	159913958	43.763218	37	20.072432	36.7658
chr3	159944103	159944485	192.55817	122	185.67	110.2974

chr3	16321169	16321550	170.67654	132	215.77864	157.09024
chr3	16354271	16354843	236.32138	252	250.9054	274.07233
chr3	16855113	16855498	30.634253	95	15.054323	40.108147
chr3	168924432	168924750	100.6554	66	70.25351	53.477528
chr3	16925411	16925756	91.902756	54	20.072432	46.792835
chr3	169357703	169358090	21.881609	60	25.09054	65.175735
chr3	16952765	16953099	135.66597	124	130.47081	135.36499
chr3	169676249	169676591	240.6977	145	205.74242	168.78845
chr3	169677135	169677477	83.150116	92	80.28973	100.27036
chr3	17023027	17023339	48.13954	36	20.072432	18.3829
chr3	171130587	171130898	8.752644	49	15.054323	55.1487
chr3	171139819	171140191	113.78436	107	95.34405	98.59919
chr3	171930617	171930856	21.881609	40	25.09054	36.7658
chr3	172327217	172327461	8.752644	49	30.108646	66.84691
chr3	174207678	174207933	13.128965	38	5.018108	10.027037
chr3	177862126	177862377	61.268505	32	45.16297	41.77932
chr3	179371116	179371581	78.77379	93	80.28973	138.70734
chr3	179461421	179461724	26.25793	34	15.054323	20.054073
chr3	179520898	179521250	78.77379	54	70.25351	21.725246
chr3	17963124	17963517	21.881609	57	50.18108	43.450493
chr3	180575593	180575953	39.386894	56	45.16297	40.108147
chr3	183206215	183206514	78.77379	39	75.27162	41.77932
chr3	183984971	183985391	105.03172	87	110.39838	103.61271
chr3	184120880	184121328	78.77379	120	65.235405	118.65327
chr3	185216633	185216985	21.881609	32	5.018108	20.054073
chr3	185218643	185218966	100.6554	91	80.28973	103.61271

chr3	185268034	185268308	30.634253	30	50.18108	35.094627
chr3	185386193	185386571	70.02115	32	75.27162	21.725246
chr3	186028082	186028353	39.386894	39	15.054323	30.08111
chr3	186498368	186498674	87.526436	43	35.126755	51.806355
chr3	187177512	187177783	26.25793	31	35.126755	20.054073
chr3	189441462	189441990	170.67654	248	100.36216	121.99561
chr3	191747467	191747741	21.881609	39	15.054323	36.7658
chr3	194861106	194861645	183.80551	186	105.380264	193.85603
chr3	194888502	194888812	48.13954	60	25.09054	46.792835
chr3	197118835	197119139	26.25793	24	55.19919	40.108147
chr3	197258552	197259059	188.18184	80	85.30783	58.491047
chr3	197262474	197262974	48.13954	41	45.16297	30.08111
chr3	197266421	197266845	26.25793	31	30.108646	25.06759
chr3	197290298	197290591	26.25793	55	40.144863	60.16222
chr3	197319504	197319908	87.526436	109	105.380264	111.968575
chr3	197338885	197339208	70.02115	51	65.235405	45.121662
chr3	197405083	197405545	96.27908	111	105.380264	86.900986
chr3	197405933	197406298	65.64483	59	60.217293	55.1487
chr3	197723259	197723702	43.763218	55	40.144863	83.55864
chr3	198655533	198655775	39.386894	52	55.19919	53.477528
chr3	20081707	20082206	113.78436	173	75.27162	150.40555
chr3	24202310	24202648	74.39747	98	55.19919	78.54512
chr3	30681512	30681833	43.763218	43	25.09054	40.108147
chr3	32157437	32157746	56.89218	42	95.34405	35.094627
chr3	32601171	32601497	30.634253	68	35.126755	55.1487
chr3	32725868	32726156	43.763218	73	90.32594	65.175735

chr3	32967915	32968311	39.386894	54	35.126755	43.450493
chr3	33070786	33071157	126.91333	86	120.434586	86.900986
chr3	33113560	33113986	166.30023	66	210.76053	45.121662
chr3	33553686	33553983	30.634253	43	60.217293	21.725246
chr3	36986405	36986754	43.763218	35	30.108646	31.752281
chr3	37044958	37045289	87.526436	53	35.126755	51.806355
chr3	37246196	37246609	214.43977	168	160.57945	178.81548
chr3	37307721	37308141	61.268505	55	25.09054	48.46401
chr3	37547562	37547939	87.526436	97	70.25351	85.22981
chr3	39375611	39375878	13.128965	35	15.054323	33.423454
chr3	39405150	39405546	126.91333	144	90.32594	165.4461
chr3	40330560	40330832	56.89218	31	45.16297	41.77932
chr3	40518561	40518884	87.526436	103	145.52513	103.61271
chr3	42183433	42183824	214.43977	180	155.56134	158.76141
chr3	42205576	42205881	39.386894	42	10.036216	18.3829
chr3	4241701	4242082	56.89218	106	70.25351	78.54512
chr3	42598675	42599039	48.13954	32	25.09054	40.108147
chr3	42831703	42832048	48.13954	49	30.108646	43.450493
chr3	42853015	42853543	192.55817	163	155.56134	145.39203
chr3	42868908	42869214	65.64483	69	40.144863	33.423454
chr3	42872622	42872969	13.128965	42	20.072432	13.369382
chr3	43687205	43687475	30.634253	32	25.09054	28.409937
chr3	43687714	43688013	43.763218	36	30.108646	35.094627
chr3	43787188	43787554	70.02115	76	90.32594	83.55864
chr3	4426010	4426358	35.010574	48	60.217293	21.725246
chr3	44943473	44943748	26.25793	68	50.18108	41.77932

chr3	45875549	45875784	30.634253	56	5.018108	60.16222
chr3	46244812	46245094	39.386894	48	25.09054	30.08111
chr3	46423502	46423818	126.91333	61	60.217293	90.243324
chr3	46519378	46519763	78.77379	115	40.144863	63.504562
chr3	46565863	46566179	26.25793	50	15.054323	36.7658
chr3	46630941	46631247	30.634253	33	15.054323	38.436974
chr3	47421354	47421677	21.881609	31	50.18108	35.094627
chr3	48224527	48224864	83.150116	94	70.25351	68.51808
chr3	48311102	48311437	35.010574	43	35.126755	36.7658
chr3	48567730	48568033	17.505287	32	15.054323	16.711727
chr3	49186031	49186371	83.150116	76	105.380264	66.84691
chr3	49362134	49362512	56.89218	124	75.27162	138.70734
chr3	49372043	49372396	35.010574	30	50.18108	36.7658
chr3	49373753	49374062	118.16069	117	150.54324	140.37851
chr3	49513414	49513707	39.386894	23	25.09054	33.423454
chr3	49685720	49686203	253.82666	140	250.9054	152.07672
chr3	50304011	50304346	35.010574	44	40.144863	48.46401
chr3	50551983	50552337	126.91333	82	110.39838	86.900986
chr3	52772524	52772781	21.881609	32	20.072432	18.3829
chr3	52921947	52922415	74.39747	131	80.28973	115.31092
chr3	53020238	53020556	8.752644	36	10.036216	21.725246
chr3	5445504	5445965	83.150116	137	80.28973	147.0632
chr3	56799561	56799826	13.128965	42	45.16297	33.423454
chr3	56805284	56805571	21.881609	38	30.108646	35.094627
chr3	57238019	57238309	8.752644	35	35.126755	33.423454
chr3	57548792	57549059	30.634253	54	75.27162	63.504562

chr3	59479122	59479386	13.128965	40	25.09054	25.06759
chr3	60950819	60951178	48.13954	59	85.30783	51.806355
chr3	61112838	61113196	83.150116	57	30.108646	38.436974
chr3	63897673	63898012	30.634253	47	25.09054	48.46401
chr3	63976250	63976585	135.66597	79	85.30783	63.504562
chr3	67150327	67150699	43.763218	74	30.108646	43.450493
chr3	69923734	69924159	109.40804	77	65.235405	56.819874
chr3	70697752	70698035	48.13954	50	25.09054	36.7658
chr3	71532911	71533217	65.64483	55	25.09054	40.108147
chr3	72420709	72421161	201.3108	145	205.74242	162.10376
chr3	72876229	72876490	17.505287	29	40.144863	31.752281
chr3	73275768	73276078	52.51586	24	35.126755	31.752281
chr3	8459916	8460179	13.128965	35	15.054323	25.06759
chr3	87310552	87310800	35.010574	53	35.126755	33.423454
chr3	9753501	9753768	13.128965	16	35.126755	33.423454
chr3	99785214	99785734	210.06345	245	220.79675	257.3606
chr3	99795120	99795499	26.25793	30	65.235405	40.108147
chr3	9995670	9995921	35.010574	69	40.144863	83.55864
chr4	102432460	102432725	30.634253	37	15.054323	31.752281
chr4	103484078	103484408	43.763218	49	25.09054	40.108147
chr4	103495905	103496329	65.64483	44	70.25351	41.77932
chr4	104217440	104217723	35.010574	34	35.126755	8.355864
chr4	1066105	1066372	52.51586	44	40.144863	40.108147
chr4	109135521	109135813	21.881609	34	10.036216	38.436974
chr4	109255163	109255440	26.25793	36	15.054323	18.3829
chr4	110635264	110635528	35.010574	34	40.144863	38.436974

	chr4	110955833	110956283	26.25793	38	40.144863	43.450493
	chr4	111213685	111213960	13.128965	38	15.054323	18.3829
	chr4	119906012	119906350	74.39747	81	35.126755	65.175735
	chr4	119907821	119908144	52.51586	60	20.072432	58.491047
	chr4	124728759	124729040	70.02115	43	45.16297	20.054073
	chr4	1277923	1278217	26.25793	42	35.126755	18.3829
	chr4	129444420	129444952	52.51586	78	50.18108	66.84691
	chr4	129474918	129475243	83.150116	62	30.108646	98.59919
	chr4	129612215	129612458	17.505287	40	45.16297	43.450493
	chr4	13592772	13593129	43.763218	61	65.235405	75.202774
	chr4	139812103	139812598	100.6554	109	130.47081	125.33795
	chr4	140982099	140982444	96.27908	59	150.54324	48.46401
	chr4	142492907	142493292	30.634253	37	15.054323	16.711727
	chr4	143053449	143053795	87.526436	83	60.217293	85.22981
	chr4	144485508	144485770	21.881609	32	20.072432	21.725246
	chr4	144699346	144699684	48.13954	43	50.18108	23.396418
	chr4	145245417	145245735	39.386894	63	5.018108	50.13518
GYPA promoter	chr4	145281264	145281648	30.634253	33	25.09054	41.77932
	chr4	146637843	146638163	35.010574	30	25.09054	66.84691
	chr4	147548369	147548652	4.376322	35	25.09054	41.77932
	chr4	149414298	149414650	78.77379	120	55.19919	125.33795
	chr4	152812330	152812797	78.77379	110	95.34405	85.22981
	chr4	152814495	152814793	30.634253	53	25.09054	41.77932
	chr4	152886442	152886830	35.010574	36	20.072432	10.027037
	chr4	153750081	153750443	83.150116	81	70.25351	68.51808
	chr4	153771013	153771315	61.268505	49	75.27162	40.108147



chr4	154102399	154102686	118.16069	72	115.41648	58.491047
chr4	154164703	154165112	183.80551	140	170.61566	80.21629
chr4	154199035	154199289	17.505287	39	25.09054	35.094627
chr4	154220450	154220985	223.19241	216	215.77864	212.23894
chr4	154278895	154279191	35.010574	75	35.126755	75.202774
chr4	154604688	154605023	26.25793	81	20.072432	96.92802
chr4	154669248	154669758	126.91333	164	130.47081	172.1308
chr4	156203512	156203968	157.54758	131	135.4889	115.31092
chr4	160182837	160183167	70.02115	103	50.18108	103.61271
chr4	160291629	160292100	271.33194	238	245.88728	282.4282
chr4	169579461	169579757	48.13954	54	55.19919	33.423454
chr4	170823200	170823497	26.25793	31	20.072432	20.054073
chr4	171164788	171165135	113.78436	175	130.47081	208.89659
chr4	174156844	174157078	100.6554	104	75.27162	90.243324
chr4	174416005	174416326	26.25793	30	35.126755	31.752281
chr4	175413565	175413876	56.89218	39	20.072432	35.094627
chr4	175812398	175812738	21.881609	49	95.34405	78.54512
chr4	180908646	180908976	35.010574	77	15.054323	61.833393
chr4	184399308	184399668	43.763218	60	55.19919	43.450493
chr4	184614075	184614401	52.51586	45	35.126755	31.752281
chr4	185544520	185544861	56.89218	67	65.235405	58.491047
chr4	185571405	185571689	43.763218	48	70.25351	40.108147
chr4	185904297	185904622	52.51586	51	35.126755	30.08111
chr4	190996952	190997337	144.41862	118	125.4527	137.03616
chr4	191132733	191132980	21.881609	32	0	26.738764
chr4	37772354	37772744	21.881609	64	45.16297	58.491047

chr4	38060533	38060812	35.010574	36	15.054323	23.396418
chr4	38217516	38217804	39.386894	50	35.126755	41.77932
chr4	38340137	38340460	74.39747	50	65.235405	53.477528
chr4	38345239	38345567	17.505287	51	25.09054	56.819874
chr4	38584088	38584355	74.39747	41	55.19919	36.7658
chr4	47433472	47433719	52.51586	46	45.16297	43.450493
chr4	47900560	47900849	83.150116	105	70.25351	113.63975
chr4	48192840	48193083	4.376322	31	35.126755	16.711727
chr4	48377917	48378384	78.77379	111	40.144863	90.243324
chr4	48380573	48380890	78.77379	43	70.25351	36.7658
chr4	5056096	5056458	61.268505	81	70.25351	71.86043
chr4	5088983	5089290	83.150116	57	30.108646	58.491047
chr4	5090121	5090465	70.02115	43	45.16297	38.436974
chr4	5197020	5197388	30.634253	52	70.25351	65.175735
chr4	54615483	54615741	0	38	15.054323	26.738764
chr4	55034140	55034392	8.752644	34	0	26.738764
chr4	55132184	55132474	21.881609	32	35.126755	28.409937
chr4	56610723	56611103	35.010574	53	45.16297	28.409937
chr4	56950515	56950907	109.40804	97	100.36216	93.58567
chr4	6783218	6783663	201.3108	210	200.72432	242.32005
chr4	6821936	6822312	26.25793	50	20.072432	41.77932
chr4	6942104	6942464	61.268505	69	70.25351	66.84691
chr4	71987667	71988195	157.54758	296	215.77864	334.23456
chr4	73654341	73654658	35.010574	47	35.126755	23.396418
chr4	75367510	75367830	17.505287	44	25.09054	35.094627
chr4	79586811	79587112	74.39747	47	95.34405	21.725246

chr4	79762857	79763159	61.268505	51	25.09054	43.450493
chr4	79805332	79805749	78.77379	98	55.19919	73.5316
chr4	79832115	79832618	201.3108	337	210.76053	447.8743
chr4	79872727	79873066	52.51586	46	25.09054	50.13518
chr4	79904625	79904878	52.51586	45	40.144863	45.121662
chr4	79910497	79910803	30.634253	33	45.16297	31.752281
chr4	82398069	82398362	39.386894	41	10.036216	36.7658
chr4	82561660	82562032	43.763218	59	50.18108	81.88747
chr4	82930716	82931053	105.03172	95	70.25351	93.58567
chr4	82932719	82932975	8.752644	33	5.018108	21.725246
chr4	82946735	82947049	70.02115	45	20.072432	36.7658
chr4	8356175	8356496	8.752644	18	10.036216	33.423454
chr4	88157767	88158110	100.6554	85	50.18108	85.22981
chr4	88194598	88194943	35.010574	67	55.19919	40.108147
chr4	89536896	89537208	21.881609	55	25.09054	26.738764
chr4	90439774	90440062	83.150116	33	75.27162	35.094627
chr4	90976193	90976563	188.18184	50	205.74242	66.84691
chr4	91003770	91004093	35.010574	37	60.217293	83.55864
chr4	95690569	95690831	70.02115	45	60.217293	23.396418
chr4	97580277	97580565	17.505287	40	30.108646	25.06759
chr4	97612185	97612592	8.752644	45	20.072432	41.77932
chr4	9791811	9792383	113.78436	107	125.4527	83.55864
chr4	9936902	9937221	65.64483	75	135.4889	83.55864
chr4	99826989	99827457	100.6554	159	55.19919	155.41907
chr5	100447977	100448332	43.763218	59	25.09054	40.108147
chr5	102458440	102458739	13.128965	31	20.072432	20.054073

chr5	10655107	10655402	30.634253	65	40.144863	60.16222
chr5	107634801	107635072	96.27908	63	90.32594	46.792835
chr5	109067370	109067742	48.13954	80	35.126755	98.59919
chr5	111569627	111569901	39.386894	32	30.108646	23.396418
chr5	111581783	111582073	13.128965	36	5.018108	18.3829
chr5	111899011	111899271	26.25793	31	25.09054	10.027037
chr5	111913318	111913754	153.17126	136	140.50702	153.7479
chr5	1120987	1121256	170.67654	87	175.63377	113.63975
chr5	114827574	114827912	166.30023	150	160.57945	110.2974
chr5	114860888	114861164	43.763218	39	20.072432	43.450493
chr5	1158592	1158900	70.02115	93	65.235405	105.28388
chr5	118693740	118694530	196.93448	213	205.74242	180.48665
chr5	118725362	118725694	43.763218	40	15.054323	36.7658
chr5	1238908	1239303	43.763218	35	40.144863	45.121662
chr5	126339981	126340333	39.386894	45	45.16297	30.08111
chr5	126340451	126340844	135.66597	176	80.28973	185.50017
chr5	130544078	130544341	26.25793	34	25.09054	21.725246
chr5	130994116	130994459	83.150116	82	75.27162	76.87395
chr5	131003774	131004118	30.634253	63	55.19919	50.13518
chr5	131358044	131358600	175.05287	143	190.6881	157.09024
chr5	131677638	131678110	262.5793	194	306.10458	255.68942
chr5	131679087	131679523	293.21356	186	306.10458	213.91011
chr5	131748236	131748570	26.25793	36	40.144863	26.738764
chr5	131786354	131786621	83.150116	108	95.34405	130.35147
chr5	133266072	133266521	52.51586	35	60.217293	55.1487
chr5	133300280	133300550	43.763218	58	80.28973	70.189255

chr5	134497698	134497928	21.881609	39	30.108646	36.7658
chr5	134498244	134498507	21.881609	24	40.144863	35.094627
chr5	134499404	134500084	118.16069	102	150.54324	177.14432
chr5	134555997	134556428	135.66597	133	165.59756	203.88307
chr5	134635430	134635713	39.386894	35	30.108646	36.7658
chr5	134840239	134840574	61.268505	54	30.108646	28.409937
chr5	138095977	138096450	87.526436	117	135.4889	66.84691
chr5	138291538	138291939	56.89218	68	55.19919	65.175735
chr5	138333432	138333819	13.128965	42	25.09054	13.369382
chr5	138552187	138552536	30.634253	40	50.18108	21.725246
chr5	138639673	138639951	30.634253	46	50.18108	38.436974
chr5	139029679	139029952	122.53701	53	190.6881	46.792835
chr5	139577281	139577616	78.77379	129	65.235405	93.58567
chr5	140038821	140039153	83.150116	74	45.16297	36.7658
chr5	14330545	14330786	13.128965	33	30.108646	15.040555
chr5	14379668	14379997	96.27908	57	110.39838	63.504562
chr5	14449891	14450209	17.505287	32	40.144863	30.08111
chr5	14482142	14482536	52.51586	90	85.30783	90.243324
chr5	145214400	145214788	35.010574	60	25.09054	58.491047
chr5	146986341	146986622	26.25793	76	45.16297	71.86043
chr5	148422906	148423272	30.634253	60	45.16297	46.792835
chr5	148816567	148816861	113.78436	80	135.4889	71.86043
chr5	148879427	148879708	8.752644	35	10.036216	40.108147
chr5	148882160	148882471	83.150116	51	20.072432	36.7658
chr5	148965788	148966178	175.05287	156	125.4527	113.63975
chr5	14914526	14914802	56.89218	50	10.036216	33.423454

chr5	14922272	14922735	100.6554	89	55.19919	96.92802
chr5	149386650	149386936	87.526436	52	65.235405	46.792835
chr5	149415124	149415517	56.89218	112	65.235405	73.5316
chr5	150819740	150820049	21.881609	31	20.072432	25.06759
chr5	150825259	150825695	61.268505	119	70.25351	105.28388
chr5	153253635	153253890	13.128965	22	85.30783	31.752281
chr5	153557093	153557482	96.27908	88	50.18108	81.88747
chr5	153733449	153733903	70.02115	54	60.217293	58.491047
chr5	154013726	154014113	455.13745	274	506.8289	325.8787
chr5	154135961	154136285	43.763218	34	75.27162	28.409937
chr5	154178261	154178546	17.505287	58	50.18108	60.16222
chr5	154194581	154195046	135.66597	154	80.28973	157.09024
chr5	154235059	154235326	48.13954	21	50.18108	51.806355
chr5	157092256	157092547	21.881609	52	40.144863	56.819874
chr5	157104281	157104631	78.77379	67	70.25351	73.5316
chr5	159620472	159620970	109.40804	202	95.34405	198.86955
chr5	16536023	16536438	39.386894	76	65.235405	35.094627
chr5	167930404	167930727	21.881609	40	10.036216	38.436974
chr5	168173134	168173660	231.94505	173	210.76053	165.4461
chr5	168235476	168235840	61.268505	85	65.235405	80.21629
chr5	168236993	168237413	214.43977	191	180.65189	233.96419
chr5	169608230	169608616	140.0423	133	140.50702	127.009125
chr5	169676637	169676930	30.634253	51	20.072432	55.1487
chr5	170622810	170623040	17.505287	32	15.054323	26.738764
chr5	171503942	171504323	65.64483	79	60.217293	55.1487
chr5	172132163	172132586	122.53701	105	135.4889	88.57216

chr5	172683741	172683999	35.010574	33	20.072432	18.3829
chr5	173190835	173191113	13.128965	36	10.036216	31.752281
chr5	173198784	173199252	74.39747	100	85.30783	86.900986
chr5	173220219	173220621	196.93448	192	240.86917	222.26598
chr5	173244969	173245289	109.40804	62	95.34405	78.54512
chr5	177487062	177487295	13.128965	61	20.072432	48.46401
chr5	177808856	177809137	26.25793	37	10.036216	13.369382
chr5	179180981	179181273	113.78436	32	170.61566	38.436974
chr5	179914921	179915243	56.89218	88	25.09054	81.88747
chr5	29831939	29832343	96.27908	163	70.25351	150.40555
chr5	30012726	30013014	39.386894	44	15.054323	45.121662
chr5	31114923	31115317	35.010574	55	35.126755	60.16222
chr5	31472780	31473070	0	36	0	21.725246
chr5	31933927	31934332	48.13954	50	105.380264	43.450493
chr5	32321392	32321733	39.386894	94	35.126755	73.5316
chr5	34735660	34735943	39.386894	33	30.108646	18.3829
chr5	37223452	37223799	83.150116	118	140.50702	111.968575
chr5	39292532	39292790	8.752644	38	0	15.040555
chr5	40088680	40089107	74.39747	78	65.235405	63.504562
chr5	41774614	41774931	43.763218	50	30.108646	41.77932
chr5	42908715	42908960	118.16069	89	55.19919	76.87395
chr5	43808689	43808986	8.752644	28	20.072432	40.108147
chr5	49716025	49716366	52.51586	57	60.217293	76.87395
chr5	53657232	53657594	157.54758	122	95.34405	111.968575
chr5	55369044	55369505	166.30023	106	145.52513	66.84691
chr5	55455203	55455713	175.05287	180	110.39838	137.03616

chr5	56008086	56008365	8.752644	35	35.126755	13.369382
chr5	56020049	56020293	26.25793	37	15.054323	21.725246
chr5	64432495	64432892	56.89218	140	120.434586	167.11728
chr5	65141795	65142117	52.51586	60	70.25351	45.121662
chr5	66143879	66144188	39.386894	38	65.235405	20.054073
chr5	67147266	67147668	21.881609	30	40.144863	45.121662
chr5	67621784	67622062	17.505287	38	25.09054	31.752281
chr5	67698862	67699314	201.3108	199	180.65189	208.89659
chr5	67746765	67747079	48.13954	40	45.16297	26.738764
chr5	67751715	67751993	48.13954	41	10.036216	31.752281
chr5	67752187	67752603	183.80551	178	140.50702	220.5948
chr5	67759753	67760251	301.96622	190	286.03214	240.64888
chr5	67812001	67812314	48.13954	61	35.126755	73.5316
chr5	67813787	67814114	8.752644	54	10.036216	55.1487
chr5	68632147	68632436	39.386894	42	30.108646	38.436974
chr5	71565779	71566037	4.376322	36	15.054323	30.08111
chr5	71929203	71929557	48.13954	50	65.235405	45.121662
chr5	72285217	72285580	131.28966	97	95.34405	86.900986
chr5	75859184	75859571	74.39747	75	125.4527	63.504562
chr5	75989519	75989949	175.05287	171	386.39432	210.56776
chr5	76181547	76181835	30.634253	41	55.19919	30.08111
chr5	76278734	76279071	61.268505	53	70.25351	58.491047
chr5	77213137	77213431	43.763218	42	30.108646	26.738764
chr5	77854915	77855324	113.78436	102	125.4527	121.99561
chr5	77919182	77919694	201.3108	199	170.61566	203.88307
chr5	79142629	79143068	35.010574	57	20.072432	70.189255



chr5	79410493	79410865	48.13954	34	85.30783	51.806355
chr5	79985101	79985417	39.386894	28	70.25351	68.51808
chr5	81086244	81086589	43.763218	58	35.126755	50.13518
chr5	85858423	85858764	17.505287	47	60.217293	45.121662
chr5	86447530	86447830	78.77379	73	115.41648	78.54512
chr5	89975741	89976128	140.0423	103	205.74242	133.69382
chr5	92944381	92944699	26.25793	49	55.19919	35.094627
chr5	93035608	93036035	161.9239	175	105.380264	165.4461
chr5	95010017	95010330	65.64483	43	60.217293	56.819874
chr5	95295883	95296314	70.02115	86	105.380264	95.25684
chr5	95358695	95359102	65.64483	40	75.27162	25.06759
chr5	95392709	95392971	65.64483	48	15.054323	53.477528
chr5	95442976	95443255	39.386894	42	35.126755	48.46401
chr5	96103402	96103736	65.64483	73	80.28973	45.121662
chr6	10833268	10833685	52.51586	50	20.072432	38.436974
chr6	10857946	10858369	83.150116	90	70.25351	78.54512
chr6	10879768	10880071	39.386894	47	20.072432	23.396418
chr6	108970162	108970604	65.64483	90	55.19919	61.833393
chr6	108986947	108987256	56.89218	54	65.235405	80.21629
chr6	108990592	108990918	48.13954	31	35.126755	28.409937
chr6	109002622	109003068	74.39747	141	80.28973	190.51369
chr6	109003889	109004237	56.89218	60	35.126755	40.108147
chr6	109006450	109006856	91.902756	103	145.52513	130.35147
chr6	109009137	109009496	13.128965	36	35.126755	45.121662
chr6	109026106	109026430	21.881609	30	45.16297	31.752281
chr6	109530691	109530938	21.881609	31	10.036216	31.752281

chr6	109768230	109768546	61.268505	44	20.072432	38.436974
chr6	110629225	110629736	30.634253	53	45.16297	58.491047
chr6	110895698	110896130	131.28966	110	100.36216	118.65327
chr6	112031620	112031961	30.634253	36	50.18108	33.423454
chr6	112232851	112233123	30.634253	56	50.18108	36.7658
chr6	114387182	114387428	43.763218	36	5.018108	30.08111
chr6	117194343	117194682	48.13954	41	75.27162	20.054073
chr6	119842963	119843353	56.89218	49	35.126755	38.436974
chr6	119990190	119990540	153.17126	118	125.4527	133.69382
chr6	125128116	125128553	135.66597	112	110.39838	125.33795
chr6	125446076	125446389	135.66597	68	95.34405	40.108147
chr6	125891404	125891691	61.268505	52	45.16297	46.792835
chr6	126113134	126113410	21.881609	30	40.144863	36.7658
chr6	126152530	126153043	61.268505	62	40.144863	35.094627
chr6	126235038	126235336	43.763218	52	25.09054	23.396418
chr6	126475147	126475486	43.763218	68	70.25351	56.819874
chr6	129870740	129871067	126.91333	107	80.28973	103.61271
chr6	130026065	130026301	30.634253	32	45.16297	28.409937
chr6	130064634	130064894	13.128965	33	40.144863	21.725246
chr6	130569343	130569637	30.634253	15	45.16297	43.450493
chr6	131391569	131391838	21.881609	32	15.054323	10.027037
chr6	132876043	132876355	39.386894	30	50.18108	55.1487
chr6	133327040	133327367	43.763218	76	35.126755	81.88747
chr6	134064455	134064784	35.010574	56	10.036216	50.13518
chr6	134320801	134321046	30.634253	38	30.108646	45.121662
chr6	13443066	13443456	83.150116	91	90.32594	100.27036

chr6	134558430	134558712	70.02115	38	30.108646	23.396418
chr6	13503506	13503769	0	46	20.072432	40.108147
chr6	13514033	13514399	52.51586	38	60.217293	36.7658
chr6	13516038	13516388	39.386894	53	55.19919	40.108147
chr6	135436936	135437171	30.634253	31	10.036216	21.725246
chr6	135459982	135460419	61.268505	35	45.16297	20.054073
chr6	135480939	135481272	21.881609	32	25.09054	11.698209
chr6	135554625	135554876	35.010574	33	50.18108	21.725246
chr6	135684179	135684486	61.268505	54	35.126755	40.108147
chr6	135685969	135686426	43.763218	35	40.144863	35.094627
chr6	13624174	13624431	26.25793	41	15.054323	30.08111
chr6	138226136	138226470	39.386894	24	20.072432	43.450493
chr6	139582216	139582598	65.64483	36	60.217293	23.396418
chr6	139808323	139808648	56.89218	84	60.217293	68.51808
chr6	139896982	139897285	118.16069	75	60.217293	51.806355
chr6	140011227	140011564	52.51586	39	35.126755	28.409937
chr6	14021173	14021501	17.505287	28	0	40.108147
chr6	14088146	14088416	56.89218	36	35.126755	30.08111
chr6	142763358	142763713	113.78436	79	95.34405	40.108147
chr6	145249504	145249803	43.763218	129	45.16297	106.955055
chr6	14585087	14585442	126.91333	92	135.4889	83.55864
chr6	147277370	147277790	52.51586	85	70.25351	86.900986
chr6	14836849	14837200	17.505287	37	50.18108	51.806355
chr6	14842819	14843250	218.81609	151	215.77864	167.11728
chr6	149482180	149482437	26.25793	32	25.09054	25.06759
chr6	149503344	149503627	21.881609	47	30.108646	41.77932

chr6	149572674	149572928		78.77379	100	55.19919	78.54512
chr6	15020373	15020730		35.010574	39	40.144863	43.450493
chr6	15197006	15197296		70.02115	74	105.380264	68.51808
chr6	15215210	15215471		43.763218	39	35.126755	25.06759
chr6	152454777	152455199		43.763218	52	25.09054	45.121662
chr6	15412889	15413270		30.634253	59	20.072432	53.477528
chr6	154935432	154935834		78.77379	70	30.108646	60.16222
chr6	15590183	15590456		17.505287	23	25.09054	33.423454
chr6	156099660	156100036		140.0423	136	115.41648	203.88307
chr6	157802553	157802848	YES qPCR	17.505287	10	60.217293	40.108147
chr6	157829644	157829986		100.6554	56	90.32594	51.806355
chr6	157856046	157856470		148.79494	94	155.56134	160.43259
chr6	158247495	158247827		48.13954	104	50.18108	75.202774
chr6	159158321	159158681		39.386894	31	60.217293	35.094627
chr6	159840152	159840432		43.763218	121	55.19919	137.03616
chr6	160372890	160373246		61.268505	65	90.32594	78.54512
chr6	160442484	160442875		39.386894	126	60.217293	123.66679
chr6	161595884	161596244		157.54758	140	135.4889	148.73438
chr6	161606488	161606887		39.386894	39	100.36216	61.833393
chr6	16323755	16324054		61.268505	62	35.126755	53.477528
chr6	16375903	16376212		48.13954	44	100.36216	46.792835
chr6	16378353	16378994		258.20297	259	225.81485	285.77054
chr6	164383427	164383686	YES	4.376322	17	40.144863	31.752281
chr6	167045829	167046212		48.13954	81	75.27162	100.27036
chr6	167051609	167051966		91.902756	108	115.41648	130.35147
chr6	167052051	167052325		30.634253	50	70.25351	46.792835

	chr6	20177326	20177652		26.25793	28	15.054323	31.752281
	chr6	20517922	20518246		39.386894	54	30.108646	43.450493
	chr6	20683415	20683654		78.77379	43	50.18108	40.108147
	chr6	24559842	24560310		39.386894	60	20.072432	71.86043
	chr6	24601784	24602077	YES	4.376322	36	45.16297	60.16222
	chr6	25806738	25807241		118.16069	128	85.30783	132.02264
TRIM10 promoter	chr6	30236540	30237299		354.48206	267	396.4305	374.34268
	chr6	30691443	30692141		91.902756	35	35.126755	46.792835
	chr6	30788329	30788709		30.634253	46	20.072432	33.423454
	chr6	31064244	31064540		39.386894	35	30.108646	20.054073
	chr6	31762320	31762613		13.128965	32	40.144863	23.396418
	chr6	31777691	31778048		61.268505	53	90.32594	83.55864
	chr6	32183190	32183494		30.634253	55	45.16297	48.46401
	chr6	32207341	32207672		293.21356	145	366.32187	170.45963
	chr6	32272561	32272869		26.25793	32	30.108646	13.369382
	chr6	3233643	3233946		8.752644	31	20.072432	31.752281
	chr6	32364230	32364548		61.268505	58	35.126755	38.436974
	chr6	3363811	3364110		39.386894	42	25.09054	28.409937
	chr6	3372880	3373244		17.505287	49	10.036216	16.711727
	chr6	34349080	34349347		30.634253	34	10.036216	20.054073
	chr6	34691372	34691760		39.386894	50	25.09054	36.7658
	chr6	3516504	3516818		48.13954	52	45.16297	55.1487
	chr6	3596136	3596540		175.05287	128	210.76053	137.03616
	chr6	36192766	36193073		56.89218	37	40.144863	26.738764
	chr6	36194317	36194738		140.0423	96	125.4527	85.22981
	chr6	36423431	36423850		118.16069	75	85.30783	56.819874

chr6	36653163	36653419	35.010574	31	30.108646	25.06759
chr6	37179050	37179495	144.41862	133	120.434586	128.6803
chr6	37185795	37186077	26.25793	30	25.09054	33.423454
chr6	37377716	37378275	214.43977	217	215.77864	272.40115
chr6	37390546	37390933	161.9239	186	150.54324	232.29301
chr6	37535936	37536345	166.30023	172	110.39838	203.88307
chr6	37743330	37743613	26.25793	32	25.09054	11.698209
chr6	39263312	39263609	21.881609	38	15.054323	30.08111
chr6	40596465	40596697	17.505287	26	20.072432	36.7658
chr6	40791336	40791897	240.6977	222	210.76053	262.3741
chr6	41117974	41118346	74.39747	91	80.28973	65.175735
chr6	4122262	4122534	4.376322	48	10.036216	53.477528
chr6	41276315	41276608	21.881609	41	35.126755	23.396418
chr6	41894336	41894731	61.268505	63	30.108646	63.504562
chr6	42032835	42033318	35.010574	74	80.28973	43.450493
chr6	42092752	42093298	245.07402	169	235.85107	167.11728
chr6	42106654	42106888	35.010574	33	70.25351	20.054073
chr6	42167908	42168153	113.78436	82	90.32594	70.189255
chr6	4219705	4219952	105.03172	69	130.47081	73.5316
chr6	43302196	43302473	21.881609	38	10.036216	21.725246
chr6	43706884	43707221	148.79494	169	100.36216	148.73438
chr6	43852200	43852467	39.386894	40	35.126755	40.108147
chr6	44045283	44045579	21.881609	39	40.144863	38.436974
chr6	44062277	44062600	30.634253	32	65.235405	16.711727
chr6	44301497	44301807	91.902756	53	90.32594	51.806355
chr6	456783	457121	30.634253	54	5.018108	55.1487

chr6	46293444	46293821		52.51586	63	35.126755	46.792835
chr6	46349614	46349999		48.13954	58	85.30783	56.819874
chr6	4673182	4673661		78.77379	106	45.16297	101.941536
chr6	47496163	47496679		122.53701	140	85.30783	91.9145
chr6	4856355	4856723		205.68712	176	210.76053	198.86955
chr6	4873663	4873973		56.89218	36	40.144863	35.094627
chr6	4881953	4882200		21.881609	37	15.054323	16.711727
chr6	49712296	49712776		148.79494	125	60.217293	140.37851
chr6	49721903	49722314		236.32138	220	215.77864	205.55424
chr6	49811922	49812335		70.02115	96	145.52513	105.28388
chr6	51034982	51035252		30.634253	26	45.16297	33.423454
chr6	52376444	52376794		61.268505	50	50.18108	60.16222
chr6	52477425	52477818		35.010574	48	60.217293	48.46401
chr6	53040576	53040901		48.13954	96	25.09054	95.25684
chr6	53263315	53263596		48.13954	62	20.072432	48.46401
chr6	53504874	53505234		131.28966	86	90.32594	86.900986
chr6	53512351	53512736		61.268505	76	90.32594	88.57216
chr6	5412027	5412339		13.128965	75	10.036216	55.1487
chr6	5458790	5459032		39.386894	37	30.108646	15.040555
chr6	57062483	57062828		56.89218	97	50.18108	105.28388
chr6	63233127	63233367		21.881609	19	20.072432	33.423454
chr6	6424981	6425350	YES qPCR	8.752644	14	60.217293	61.833393
chr6	6649655	6650031		100.6554	73	110.39838	31.752281
chr6	6654369	6654656		39.386894	29	45.16297	46.792835
chr6	6655200	6655448	YES	21.881609	31	5.018108	3.3423455
chr6	6831549	6831994		122.53701	108	115.41648	153.7479

chr6	70929681	70929952	4.376322	36	5.018108	3.3423455
chr6	71103877	71104274	131.28966	200	90.32594	200.54073
chr6	7170098	7170519	30.634253	64	35.126755	56.819874
chr6	7413718	7414042	17.505287	42	50.18108	21.725246
chr6	7525139	7525410	21.881609	48	15.054323	20.054073
chr6	7844850	7845291	91.902756	88	105.380264	63.504562
chr6	82704792	82705140	26.25793	30	20.072432	51.806355
chr6	85036413	85036875	170.67654	131	155.56134	143.72086
chr6	86254286	86254627	48.13954	46	30.108646	31.752281
chr6	88131045	88131528	43.763218	133	35.126755	101.941536
chr6	90595770	90596065	74.39747	61	35.126755	38.436974
chr6	90925408	90925716	52.51586	47	30.108646	33.423454
chr6	90929145	90929468	43.763218	40	40.144863	26.738764
chr6	90951417	90951719	65.64483	47	45.16297	48.46401
chr7	100076959	100077397	205.68712	121	190.6881	115.31092
chr7	100329734	100330151	105.03172	114	110.39838	90.243324
chr7	100674064	100674448	109.40804	61	190.6881	78.54512
chr7	101510688	101510956	48.13954	38	20.072432	13.369382
chr7	101869180	101869448	105.03172	60	80.28973	35.094627
chr7	102353696	102353999	96.27908	64	80.28973	48.46401
chr7	102577793	102578226	105.03172	110	90.32594	120.32444
chr7	102681908	102682166	21.881609	34	65.235405	60.16222
chr7	102968785	102969074	35.010574	46	5.018108	5.0135183
chr7	1050151	1050479	109.40804	93	55.19919	60.16222
chr7	105446304	105446543	30.634253	79	5.018108	88.57216
chr7	105996561	105997050	109.40804	111	75.27162	116.98209



chr7	106406282	106406658	109.40804	111	110.39838	123.66679
chr7	106435019	106435435	175.05287	173	190.6881	111.968575
chr7	107261401	107261672	61.268505	31	60.217293	16.711727
chr7	107264017	107264468	179.4292	240	110.39838	237.30653
chr7	10809901	10810200	122.53701	100	65.235405	66.84691
chr7	110651037	110651310	26.25793	39	15.054323	31.752281
chr7	110902507	110902832	87.526436	52	50.18108	35.094627
chr7	120414586	120414888	17.505287	38	20.072432	20.054073
chr7	125032607	125032884	21.881609	20	15.054323	33.423454
chr7	127236697	127237113	96.27908	98	135.4889	127.009125
chr7	12737989	12738291	83.150116	65	65.235405	68.51808
chr7	127414190	127414567	74.39747	92	70.25351	111.968575
chr7	128577320	128577602	83.150116	61	140.50702	50.13518
chr7	129147460	129147796	48.13954	72	40.144863	66.84691
chr7	129177163	129177615	218.81609	166	270.9778	173.80197
chr7	129385672	129386145	240.6977	222	175.63377	233.96419
chr7	131825154	131825467	26.25793	40	30.108646	23.396418
chr7	133695063	133695474	61.268505	69	85.30783	76.87395
chr7	133975216	133975530	78.77379	107	80.28973	110.2974
chr7	133995775	133996105	100.6554	100	70.25351	80.21629
chr7	134170166	134170527	157.54758	96	140.50702	96.92802
chr7	134999253	134999645	188.18184	117	165.59756	128.6803
chr7	135368756	135369078	52.51586	49	90.32594	28.409937
chr7	138426148	138426524	161.9239	121	140.50702	115.31092
chr7	139262195	139262954	65.64483	185	60.217293	242.32005
chr7	139614100	139614381	39.386894	43	35.126755	33.423454

chr7	141838153	141838482	70.02115	81	60.217293	71.86043
chr7	142246402	142246775	65.64483	119	45.16297	80.21629
chr7	142369453	142369773	74.39747	71	50.18108	66.84691
chr7	146056682	146057003	56.89218	77	35.126755	50.13518
chr7	150283888	150284247	48.13954	14	115.41648	35.094627
chr7	150322603	150322926	78.77379	47	60.217293	30.08111
chr7	151339429	151339736	4.376322	48	5.018108	21.725246
chr7	155070605	155071000	52.51586	40	35.126755	33.423454
chr7	156662975	156663399	96.27908	76	85.30783	60.16222
chr7	16275110	16275553	157.54758	115	200.72432	103.61271
chr7	1654381	1654707	113.78436	46	105.380264	31.752281
chr7	17236311	17236614	30.634253	37	45.16297	35.094627
chr7	20704653	20705026	148.79494	114	130.47081	110.2974
chr7	21428937	21429174	26.25793	35	50.18108	20.054073
chr7	2310709	2311051	170.67654	139	165.59756	143.72086
chr7	23167694	23167990	30.634253	57	10.036216	48.46401
chr7	25501493	25501881	43.763218	83	45.16297	68.51808
chr7	26186900	26187130	83.150116	68	50.18108	45.121662
chr7	26206676	26206982	30.634253	19	35.126755	33.423454
chr7	2741375	2741817	223.19241	212	205.74242	260.70294
chr7	28188112	28188695	56.89218	85	45.16297	96.92802
chr7	28206867	28207159	179.4292	153	140.50702	148.73438
chr7	28209911	28210376	166.30023	183	175.63377	188.84251
chr7	28484726	28485025	35.010574	19	35.126755	43.450493
chr7	29115523	29115954	70.02115	138	75.27162	106.955055
chr7	29897997	29898295	35.010574	41	10.036216	26.738764

chr7	30150812	30151075	30.634253	34	25.09054	25.06759
chr7	30152454	30152687	13.128965	39	15.054323	26.738764
chr7	30767365	30767744	48.13954	47	75.27162	43.450493
chr7	30903233	30903847	153.17126	104	195.7062	168.78845
chr7	30921235	30921661	122.53701	92	155.56134	85.22981
chr7	30932258	30932814	192.55817	116	155.56134	111.968575
chr7	33047862	33048120	87.526436	54	70.25351	53.477528
chr7	36934510	36934844	39.386894	51	60.217293	23.396418
chr7	37082814	37083186	74.39747	54	80.28973	50.13518
chr7	37363747	37364077	74.39747	75	55.19919	76.87395
chr7	37411943	37412312	131.28966	127	125.4527	133.69382
chr7	37823756	37824111	70.02115	75	65.235405	65.175735
chr7	39816348	39816674	87.526436	83	90.32594	46.792835
chr7	44660577	44660840	8.752644	34	0	18.3829
chr7	44853546	44853873	43.763218	49	40.144863	28.409937
chr7	45007400	45007674	30.634253	29	30.108646	38.436974
chr7	45251104	45251476	21.881609	37	45.16297	15.040555
chr7	47272957	47273402	48.13954	68	50.18108	71.86043
chr7	47348953	47349261	61.268505	37	75.27162	31.752281
chr7	47380203	47380515	105.03172	93	120.434586	165.4461
chr7	47569258	47569523	13.128965	46	25.09054	30.08111
chr7	47574678	47575177	144.41862	172	180.65189	188.84251
chr7	50390936	50391333	56.89218	70	50.18108	65.175735
chr7	50391401	50391641	52.51586	38	65.235405	26.738764
chr7	50395227	50395563	74.39747	58	95.34405	63.504562
chr7	50395859	50396277	35.010574	47	55.19919	20.054073

chr7	50532218	50532595		17.505287	32	15.054323	48.46401
chr7	52009183	52009434		70.02115	35	25.09054	8.355864
chr7	5464071	5464364		52.51586	34	50.18108	11.698209
chr7	5532560	5533121		122.53701	40	70.25351	21.725246
chr7	55589297	55589574		61.268505	51	30.108646	48.46401
chr7	6028840	6029169		43.763218	62	30.108646	48.46401
chr7	6030116	6030536		183.80551	152	130.47081	167.11728
chr7	6038412	6038737		39.386894	100	70.25351	91.9145
chr7	6062817	6063131		105.03172	92	70.25351	100.27036
chr7	65656657	65656999		17.505287	27	20.072432	45.121662
chr7	65742224	65742562		126.91333	63	85.30783	75.202774
chr7	69672394	69672742		91.902756	36	70.25351	33.423454
chr7	7105775	7106187		87.526436	55	55.19919	40.108147
chr7	7106460	7106904		210.06345	221	180.65189	220.5948
chr7	7110488	7110852		78.77379	59	50.18108	58.491047
chr7	72810921	72811231		30.634253	31	25.09054	26.738764
chr7	72938482	72938772		87.526436	83	70.25351	93.58567
chr7	7620599	7620866		48.13954	33	40.144863	41.77932
chr7	76830225	76830464		8.752644	31	15.054323	21.725246
chr7	80113270	80113787		275.70828	213	200.72432	233.96419
chr7	80676220	80676588		30.634253	47	100.36216	40.108147
chr7	8207923	8208229	YES	39.386894	60	5.018108	10.027037
chr7	8232731	8233027		52.51586	59	65.235405	30.08111
chr7	90193965	90194282		13.128965	24	35.126755	35.094627
chr7	92649072	92649431		61.268505	67	30.108646	66.84691
chr7	92686306	92686602		39.386894	51	25.09054	45.121662

chr7	92686731	92687003	48.13954	45	10.036216	16.711727
chr7	93362558	93362893	26.25793	61	25.09054	61.833393
chr7	95666696	95666976	17.505287	26	55.19919	31.752281
chr7	97600398	97600756	56.89218	82	40.144863	43.450493
chr7	98366479	98366905	65.64483	58	55.19919	60.16222
chr7	99100897	99101251	35.010574	33	70.25351	35.094627
chr7	99497081	99497470	122.53701	169	115.41648	182.15782
chr7	99866493	99866752	17.505287	22	25.09054	36.7658
chr7	99946323	99946654	52.51586	39	20.072432	36.7658
chr8	101491894	101492322	135.66597	136	180.65189	125.33795
chr8	101496880	101497196	30.634253	41	65.235405	30.08111
chr8	101553625	101554006	131.28966	123	35.126755	68.51808
chr8	101845318	101845721	131.28966	177	150.54324	185.50017
chr8	103672278	103672713	170.67654	122	165.59756	140.37851
chr8	103980686	103981170	113.78436	182	180.65189	255.68942
chr8	104160309	104160567	21.881609	34	15.054323	18.3829
chr8	106601872	106602190	26.25793	85	30.108646	73.5316
chr8	10672174	10672588	109.40804	76	120.434586	70.189255
chr8	108832672	108833019	35.010574	65	65.235405	38.436974
chr8	110145425	110145783	39.386894	55	20.072432	51.806355
chr8	110450979	110451301	56.89218	41	60.217293	40.108147
chr8	110474154	110474469	87.526436	115	80.28973	101.941536
chr8	11245229	11245543	65.64483	56	75.27162	65.175735
chr8	117265359	117265795	17.505287	60	25.09054	18.3829
chr8	11757599	11757971	218.81609	159	185.67	203.88307
chr8	11774234	11774683	201.3108	122	200.72432	155.41907

chr8	123248650	123248884	48.13954	32	15.054323	36.7658
chr8	123909580	123909977	17.505287	91	30.108646	45.121662
chr8	124248842	124249212	122.53701	95	80.28973	76.87395
chr8	124263800	124264219	148.79494	195	210.76053	222.26598
chr8	12451068	12451333	113.78436	100	175.63377	175.47314
chr8	124595714	124595982	21.881609	32	25.09054	16.711727
chr8	125003519	125003870	8.752644	50	35.126755	60.16222
chr8	125655928	125656244	74.39747	73	60.217293	98.59919
chr8	125664887	125665130	17.505287	36	40.144863	25.06759
chr8	125732544	125732869	74.39747	79	60.217293	73.5316
chr8	125765955	125766220	48.13954	41	35.126755	31.752281
chr8	125924220	125924507	35.010574	37	25.09054	30.08111
chr8	125997642	125998194	288.83725	241	316.1408	252.34708
chr8	126262405	126262667	74.39747	95	60.217293	103.61271
chr8	126360506	126360811	52.51586	36	35.126755	38.436974
chr8	128980193	128980557	105.03172	69	75.27162	73.5316
chr8	129041736	129042115	43.763218	115	105.380264	68.51808
chr8	129095876	129096114	13.128965	36	20.072432	26.738764
chr8	129126415	129126730	39.386894	33	30.108646	26.738764
chr8	129130309	129130617	35.010574	32	25.09054	16.711727
chr8	13007833	13008153	48.13954	61	35.126755	40.108147
chr8	130663574	130663863	13.128965	22	45.16297	31.752281
chr8	131383811	131384142	30.634253	46	30.108646	31.752281
chr8	131424474	131424936	109.40804	114	95.34405	98.59919
chr8	131437525	131437924	78.77379	93	50.18108	75.202774
chr8	134081564	134081878	61.268505	34	15.054323	36.7658

chr8	134353224	134353524	35.010574	84	75.27162	68.51808
chr8	135624293	135624689	30.634253	35	50.18108	46.792835
chr8	141698180	141698643	236.32138	128	185.67	128.6803
chr8	141757921	141758216	21.881609	127	65.235405	140.37851
chr8	141772872	141773277	109.40804	123	110.39838	111.968575
chr8	141904370	141904679	87.526436	52	40.144863	40.108147
chr8	142343412	142343791	70.02115	54	35.126755	48.46401
chr8	142376699	142377033	35.010574	39	55.19919	36.7658
chr8	142636888	142637315	205.68712	137	230.83296	183.829
chr8	143739815	143740157	65.64483	46	45.16297	75.202774
chr8	144447345	144447668	35.010574	60	75.27162	73.5316
chr8	144552088	144552457	52.51586	39	75.27162	28.409937
chr8	145141535	145141771	30.634253	40	30.108646	33.423454
chr8	145509486	145509855	87.526436	128	60.217293	91.9145
chr8	17060468	17060706	26.25793	55	30.108646	66.84691
chr8	20136392	20136734	100.6554	45	50.18108	26.738764
chr8	21771858	21772177	78.77379	68	25.09054	35.094627
chr8	21776968	21777243	83.150116	58	120.434586	51.806355
chr8	21873877	21874322	56.89218	177	45.16297	187.17134
chr8	21973240	21973693	240.6977	113	250.9054	100.27036
chr8	22030079	22030366	61.268505	40	65.235405	28.409937
chr8	23400400	23400688	30.634253	40	25.09054	36.7658
chr8	23406060	23406592	105.03172	70	70.25351	66.84691
chr8	23407537	23408084	459.5138	330	516.8651	374.34268
chr8	23422066	23422717	223.19241	232	215.77864	235.63536
chr8	23441054	23441733	319.4715	249	235.85107	284.09937

chr8	23486362	23486795	35.010574	39	45.16297	30.08111
chr8	23486967	23487494	70.02115	48	85.30783	30.08111
chr8	24036899	24037169	21.881609	34	20.072432	21.725246
chr8	26206445	26206746	61.268505	51	25.09054	28.409937
chr8	26304467	26304866	227.56873	183	110.39838	202.2119
chr8	27228815	27229138	26.25793	77	10.036216	35.094627
chr8	27254470	27254781	30.634253	44	45.16297	33.423454
chr8	27275137	27275538	100.6554	91	100.36216	90.243324
chr8	27277072	27277449	78.77379	69	120.434586	93.58567
chr8	30148085	30148328	48.13954	60	35.126755	56.819874
chr8	37112246	37112597	61.268505	72	55.19919	98.59919
chr8	37650352	37650663	122.53701	92	145.52513	88.57216
chr8	37843796	37844106	43.763218	83	80.28973	95.25684
chr8	37868433	37868808	39.386894	60	10.036216	41.77932
chr8	38187374	38187702	52.51586	110	60.217293	111.968575
chr8	38801245	38801495	61.268505	39	35.126755	31.752281
chr8	40695278	40695649	48.13954	62	70.25351	71.86043
chr8	41744490	41744832	70.02115	58	30.108646	71.86043
chr8	41749307	41749815	148.79494	185	105.380264	197.19838
chr8	41773339	41773703	100.6554	40	95.34405	76.87395
chr8	41799731	41800064	43.763218	46	20.072432	46.792835
chr8	42010520	42010882	39.386894	62	35.126755	80.21629
chr8	42461235	42461819	105.03172	184	160.57945	213.91011
chr8	48632331	48632677	113.78436	122	105.380264	86.900986
chr8	49469158	49469402	30.634253	48	10.036216	28.409937
chr8	49509267	49509667	113.78436	137	75.27162	90.243324



chr8	49720595	49720862	13.128965	37	0	8.355864
chr8	49955215	49955461	113.78436	109	45.16297	78.54512
chr8	50376179	50376438	52.51586	34	25.09054	13.369382
chr8	53788150	53788513	70.02115	64	45.16297	76.87395
chr8	54567856	54568166	56.89218	54	70.25351	90.243324
chr8	54568978	54569469	43.763218	65	50.18108	90.243324
chr8	5808457	5808729	17.505287	30	10.036216	35.094627
chr8	5862837	5863088	17.505287	45	60.217293	71.86043
chr8	58903365	58903717	26.25793	72	75.27162	172.1308
chr8	59006253	59006600	8.752644	18	25.09054	31.752281
chr8	61651083	61651421	48.13954	50	75.27162	45.121662
chr8	62151434	62152041	126.91333	151	160.57945	110.2974
chr8	6521303	6521562	8.752644	32	0	18.3829
chr8	6618882	6619172	43.763218	27	10.036216	35.094627
chr8	66818125	66818420	48.13954	43	50.18108	21.725246
chr8	68330394	68330700	17.505287	32	15.054323	20.054073
chr8	71275991	71276281	26.25793	22	25.09054	33.423454
chr8	71297462	71297785	17.505287	32	25.09054	21.725246
chr8	81077424	81077721	26.25793	42	75.27162	31.752281
chr8	8241094	8241423	48.13954	61	30.108646	25.06759
chr8	86425316	86426112	183.80551	78	160.57945	86.900986
chr8	86451298	86452108	87.526436	48	90.32594	30.08111
chr8	86459095	86459683	65.64483	36	65.235405	11.698209
chr8	86553548	86553915	122.53701	62	65.235405	53.477528
chr8	86554868	86555285	48.13954	172	50.18108	187.17134
chr8	87040500	87040860	61.268505	97	75.27162	81.88747

## ALAD intron 1

chr8	88767950	88768235	4.376322	67	10.036216	50.13518
chr8	9059366	9059663	17.505287	34	35.126755	68.51808
chr8	91278803	91279151	17.505287	57	25.09054	25.06759
chr8	91727762	91728160	91.902756	74	105.380264	60.16222
chr8	93176735	93176979	52.51586	51	60.217293	66.84691
chr8	96249013	96249320	35.010574	56	15.054323	58.491047
chr8	97725790	97726085	35.010574	41	70.25351	23.396418
chr8	99387613	99387952	144.41862	117	60.217293	98.59919
chr9	100734255	100734487	8.752644	32	10.036216	11.698209
chr9	101886291	101886534	21.881609	44	15.054323	18.3829
chr9	103371872	103372179	61.268505	52	30.108646	35.094627
chr9	103466574	103466929	153.17126	70	95.34405	41.77932
chr9	106622468	106622777	26.25793	51	30.108646	56.819874
chr9	107187549	107187919	39.386894	55	20.072432	36.7658
chr9	109586591	109586958	48.13954	79	35.126755	63.504562
chr9	109896178	109896489	35.010574	70	75.27162	81.88747
chr9	112234442	112234780	43.763218	59	80.28973	51.806355
chr9	115024487	115024790	30.634253	29	20.072432	38.436974
chr9	115070362	115070712	21.881609	42	25.09054	21.725246
chr9	115199253	115199720	74.39747	146	105.380264	137.03616
chr9	115374307	115374902	118.16069	85	95.34405	103.61271
chr9	116041046	116041285	83.150116	35	60.217293	35.094627
chr9	118122264	118122845	227.56873	159	225.81485	165.4461
chr9	118267266	118267597	131.28966	78	215.77864	76.87395
chr9	123152966	123153331	39.386894	80	25.09054	83.55864
chr9	123171771	123172340	358.8584	165	441.5935	193.85603

chr9	123178949	123179208	4.376322	34	15.054323	6.684691
chr9	123449178	123449424	13.128965	34	20.072432	23.396418
chr9	124134249	124134632	61.268505	138	85.30783	145.39203
chr9	124623600	124624136	87.526436	149	110.39838	142.04968
chr9	124837180	124837475	61.268505	32	55.19919	21.725246
chr9	126314286	126314553	30.634253	26	25.09054	41.77932
chr9	126840351	126840619	26.25793	49	10.036216	35.094627
chr9	127315819	127316147	30.634253	69	60.217293	50.13518
chr9	129257639	129257877	8.752644	22	40.144863	31.752281
chr9	129686580	129686973	39.386894	90	75.27162	96.92802
chr9	129713273	129713597	144.41862	156	160.57945	183.829
chr9	129917684	129917969	148.79494	168	140.50702	162.10376
chr9	129952211	129952524	35.010574	30	45.16297	31.752281
chr9	130360484	130361023	109.40804	186	205.74242	192.18486
chr9	130871426	130871724	131.28966	157	170.61566	183.829
chr9	131592447	131592775	35.010574	72	40.144863	61.833393
chr9	131665146	131665470	91.902756	90	100.36216	116.98209
chr9	131681311	131681577	113.78436	102	105.380264	88.57216
chr9	131983915	131984251	43.763218	61	80.28973	63.504562
chr9	132401170	132401456	61.268505	48	75.27162	43.450493
chr9	132402607	132403175	61.268505	135	125.4527	128.6803
chr9	132709340	132709687	13.128965	37	25.09054	28.409937
chr9	132922445	132922796	43.763218	42	45.16297	43.450493
chr9	133045746	133046052	91.902756	90	140.50702	90.243324
chr9	133196458	133196844	231.94505	169	200.72432	165.4461
chr9	133399989	133400322	52.51586	35	25.09054	20.054073

chr9	134664334	134664735		39.386894	71	50.18108	51.806355
chr9	134849978	134850348		100.6554	126	145.52513	113.63975
chr9	134859816	134860142		30.634253	16	70.25351	31.752281
chr9	134864188	134864694		223.19241	178	291.05026	217.25246
chr9	134869294	134869857		100.6554	150	115.41648	158.76141
chr9	135026522	135026951		113.78436	81	120.434586	76.87395
chr9	135376679	135376971		26.25793	45	30.108646	58.491047
chr9	135716018	135716375		65.64483	56	90.32594	55.1487
chr9	135724582	135724937		52.51586	105	80.28973	75.202774
chr9	136348291	136348578		87.526436	98	70.25351	120.32444
chr9	136370078	136370554		297.58987	195	471.70215	274.07233
chr9	136388617	136388906		48.13954	35	55.19919	38.436974
chr9	137983571	137984079		175.05287	195	145.52513	230.62184
chr9	138221898	138222238		52.51586	62	115.41648	63.504562
chr9	138990173	138990517		65.64483	55	180.65189	33.423454
chr9	139255245	139255736		87.526436	39	85.30783	43.450493
chr9	14385750	14386140		135.66597	69	115.41648	43.450493
chr9	14423312	14423568		30.634253	25	35.126755	33.423454
chr9	14917112	14917465		35.010574	61	40.144863	40.108147
chr9	15393262	15393501		21.881609	43	50.18108	53.477528
chr9	15833352	15833637		61.268505	31	80.28973	26.738764
chr9	19077313	19077562	YES	0	6	30.108646	33.423454
chr9	19114011	19114285		65.64483	87	65.235405	145.39203
chr9	19144156	19144463		26.25793	53	40.144863	60.16222
chr9	20372386	20372724		21.881609	36	30.108646	21.725246
chr9	21037366	21037731		35.010574	62	45.16297	50.13518

chr9	21086390	21086810	17.505287	37	15.054323	65.175735
chr9	32544073	32544443	205.68712	148	175.63377	130.35147
chr9	32933136	32933608	70.02115	116	65.235405	173.80197
chr9	33261980	33262243	48.13954	46	30.108646	43.450493
chr9	33321297	33321736	105.03172	117	95.34405	130.35147
chr9	33436010	33436294	35.010574	31	15.054323	35.094627
chr9	34140115	34140544	157.54758	130	85.30783	83.55864
chr9	34141354	34141637	26.25793	39	10.036216	20.054073
chr9	35099239	35099626	96.27908	110	110.39838	147.0632
chr9	35718442	35718750	13.128965	48	40.144863	38.436974
chr9	35803807	35804056	21.881609	31	15.054323	26.738764
chr9	36132590	36132886	21.881609	34	15.054323	23.396418
chr9	37187076	37187462	78.77379	78	55.19919	50.13518
chr9	37669045	37669363	39.386894	69	45.16297	56.819874
chr9	37670042	37670363	105.03172	95	35.126755	70.189255
chr9	37895271	37895591	35.010574	25	70.25351	40.108147
chr9	435045	435325	39.386894	36	25.09054	20.054073
chr9	4753205	4753545	52.51586	71	105.380264	105.28388
chr9	4788436	4788678	17.505287	51	55.19919	31.752281
chr9	4818757	4819002	17.505287	37	45.16297	28.409937
chr9	4852706	4853209	61.268505	131	105.380264	115.31092
chr9	5182083	5182317	30.634253	36	20.072432	8.355864
chr9	5473356	5473611	52.51586	33	35.126755	21.725246
chr9	6747005	6747535	56.89218	54	65.235405	55.1487
chr9	67911852	67912228	30.634253	56	15.054323	30.08111
chr9	6883351	6883760	78.77379	70	70.25351	66.84691

chr9	6886587	6886888	65.64483	99	65.235405	61.833393
chr9	70525527	70525835	13.128965	93	40.144863	106.955055
chr9	70551787	70552232	126.91333	163	75.27162	152.07672
chr9	70787912	70788219	48.13954	67	25.09054	46.792835
chr9	70823455	70823865	52.51586	81	45.16297	125.33795
chr9	70992042	70992367	61.268505	61	45.16297	40.108147
chr9	71020658	71021015	39.386894	90	50.18108	71.86043
chr9	71337052	71337501	56.89218	103	65.235405	86.900986
chr9	71925507	71925859	65.64483	74	20.072432	83.55864
chr9	72289952	72290447	306.34253	184	255.92351	213.91011
chr9	73547085	73547321	35.010574	48	30.108646	28.409937
chr9	74384964	74385297	65.64483	109	30.108646	76.87395
chr9	76856069	76856372	61.268505	71	35.126755	65.175735
chr9	78435652	78436019	61.268505	66	40.144863	30.08111
chr9	78472277	78472512	8.752644	48	25.09054	50.13518
chr9	79791855	79792152	39.386894	33	20.072432	13.369382
chr9	79826531	79826903	83.150116	75	90.32594	51.806355
chr9	85454342	85454709	17.505287	43	15.054323	15.040555
chr9	87932438	87932759	35.010574	40	75.27162	33.423454
chr9	88089894	88090290	135.66597	140	75.27162	138.70734
chr9	88091052	88091385	109.40804	118	85.30783	121.99561
chr9	89323252	89323897	175.05287	172	140.50702	195.5272
chr9	89479278	89479677	35.010574	146	20.072432	170.45963
chr9	89608701	89609061	87.526436	144	85.30783	155.41907
chr9	89615388	89615803	70.02115	134	40.144863	153.7479
chr9	90857340	90857883	91.902756	128	55.19919	111.968575

chr9	91237106	91237356	148.79494	98	95.34405	81.88747
chr9	91411424	91411841	78.77379	64	85.30783	61.833393
chr9	91915161	91915431	26.25793	35	40.144863	8.355864
chr9	93797422	93797791	30.634253	52	40.144863	36.7658
chr9	93847113	93847447	61.268505	50	40.144863	41.77932
chr9	94457133	94457509	61.268505	42	45.16297	48.46401
chr9	99082986	99083257	17.505287	22	90.32594	35.094627
chr9	99305557	99305869	65.64483	105	75.27162	95.25684
chr9	99740133	99740633	131.28966	193	115.41648	228.95067
chr9	99742370	99742781	70.02115	72	60.217293	65.175735
chr9	99745329	99745775	140.0423	169	85.30783	210.56776
chr9	99762999	99763331	70.02115	124	95.34405	123.66679
chrX	100502121	100502469	56.89218	61	110.39838	58.491047
chrX	10087105	10087435	17.505287	38	45.16297	35.094627
chrX	10107011	10107287	61.268505	53	80.28973	58.491047
chrX	102265884	102266118	56.89218	36	35.126755	33.423454
chrX	10510476	10510790	30.634253	33	15.054323	21.725246
chrX	106298223	106298461	30.634253	33	0	16.711727
chrX	106707854	106708185	65.64483	68	60.217293	55.1487
chrX	10748069	10748380	96.27908	73	95.34405	101.941536
chrX	10779945	10780195	52.51586	47	55.19919	33.423454
chrX	108972136	108972378	52.51586	30	15.054323	35.094627
chrX	109308372	109308745	61.268505	110	35.126755	103.61271
chrX	109529884	109530249	52.51586	58	55.19919	40.108147
chrX	109532774	109533092	61.268505	74	75.27162	51.806355
chrX	122746487	122746789	70.02115	82	75.27162	88.57216

chrX	123310631	123310932	74.39747	84	50.18108	81.88747
chrX	123660306	123660629	43.763218	35	30.108646	60.16222
chrX	123725941	123726226	74.39747	57	25.09054	43.450493
chrX	129141278	129141604	35.010574	75	45.16297	98.59919
chrX	129556061	129556353	87.526436	99	65.235405	73.5316
chrX	132360532	132360828	26.25793	16	5.018108	38.436974
chrX	133870976	133871380	61.268505	62	35.126755	56.819874
chrX	134483877	134484205	4.376322	44	25.09054	33.423454
chrX	13575679	13576052	100.6554	90	80.28973	137.03616
chrX	149285036	149285424	70.02115	63	40.144863	63.504562
chrX	150552318	150552676	52.51586	48	55.19919	66.84691
chrX	153680538	153680969	65.64483	81	65.235405	91.9145
chrX	154217185	154217455	48.13954	48	40.144863	30.08111
chrX	16884633	16884947	52.51586	45	25.09054	21.725246
chrX	17000489	17000726	30.634253	35	25.09054	33.423454
chrX	19259904	19260144	52.51586	39	25.09054	25.06759
chrX	23592618	23592853	35.010574	25	60.217293	38.436974
chrX	23815549	23815912	56.89218	58	65.235405	55.1487
chrX	30809892	30810198	21.881609	53	10.036216	43.450493
chrX	37397031	37397355	35.010574	44	30.108646	46.792835
chrX	37424096	37424383	13.128965	43	5.018108	35.094627
chrX	37460910	37461232	21.881609	55	35.126755	60.16222
chrX	38393904	38394244	52.51586	57	45.16297	71.86043
chrX	38397362	38397704	109.40804	149	170.61566	175.47314
chrX	38896559	38896952	61.268505	74	35.126755	46.792835
chrX	39235874	39236256	48.13954	49	25.09054	75.202774



	chrX	40010768	40011035	13.128965	34	35.126755	18.3829
	chrX	40288573	40288911	126.91333	63	145.52513	51.806355
	chrX	40294302	40294616	56.89218	39	70.25351	36.7658
	chrX	40828608	40828928	196.93448	31	205.74242	40.108147
	chrX	44058470	44058789	39.386894	68	35.126755	66.84691
	chrX	48439580	48439875	26.25793	38	15.054323	23.396418
HS-3.5 GATA1	chrX	48526253	48526572	100.6554	85	165.59756	85.22981
IE GATA1 promoter	chrX	48529179	48529450	74.39747	39	35.126755	43.450493
HS+14 GATA1	chrX	48543919	48544307	52.51586	45	50.18108	41.77932
	chrX	48682792	48683097	52.51586	63	35.126755	55.1487
	chrX	48703787	48704105	52.51586	59	40.144863	61.833393
	chrX	49342529	49342816	17.505287	35	15.054323	33.423454
	chrX	53085164	53085447	65.64483	63	50.18108	43.450493
	chrX	54332088	54332652	109.40804	124	115.41648	108.62623
	chrX	55058014	55058504	157.54758	135	175.63377	153.7479
	chrX	55071234	55071626	105.03172	85	95.34405	121.99561
	chrX	55173675	55174102	52.51586	45	15.054323	50.13518
	chrX	56323109	56323358	43.763218	47	30.108646	50.13518
	chrX	56841216	56841534	61.268505	37	35.126755	38.436974
	chrX	70268077	70268475	43.763218	94	55.19919	93.58567
	chrX	77080236	77080606	83.150116	60	85.30783	61.833393
	chrX	9932023	9932255	17.505287	11	10.036216	31.752281
	chrX	9935767	9936047	52.51586	50	70.25351	41.77932
	chrX	9973394	9973704	30.634253	39	55.19919	61.833393
	chrX	9975260	9975653	65.64483	96	25.09054	93.58567
	chrY	11753449	11753725	13.128965	33	5.018108	33.423454

chrY	13045237	13045538	26.25793	44	25.09054	21.725246
chrY	14492684	14493044	56.89218	79	45.16297	110.2974

---

**Table S4.** Primer sequences for sequence analysis

<b>Sequence amplicon</b>	<b>Forward Primer</b>	<b>Reverse Primer</b>
Chr12:812	TGGAGCAGACAAATTAGAGGC	CGAAAAGCGCCATCTTACTC
Chr13:4146	CATGCTTCCAAATGGTTCCT	CCTTTACTGTGCTTCCCACA
Chr13:4149	CTGTTTTCTGTCTTTGCCA	AGGTCCCCACATGATTTTG
Chr15:917	TCCCTTAACCATAGAGTTGGAG	AAGCACAGGTCATCTTACGC
Chr19:193	GGGCGAAAGCACAGGTTGCTG	GGGGGACACACGAGGACGGA
Chr2:119	ACCAGTAACAGAAGGGCTCC	TATACCAACCCAGGTGGACA
Chr7:102	GAGTGTTCCCCACACCCTT	ACAAATGTAAACGTCACTAGACCC
Chr1:118	TGAAGCAGGCAGAGCTCAGAGGA	TGGACCAGCAGAGCCAGGACT
Chr15:963	GCCTGTAAGACTGCAAAGTAAG	GGCACATCTTTACCAGACAA
Chr16:734	CCTGGCTTTCATCTCAACAA	AGAGCCGTAGCCTTTGATTC
Chr2:236	CCTTTACAAACAGCCCAAGG	TCACGAGGAAGA ACTTTGGAG
Chr22:227	GCCACTCTGTTCCCTCACAG	GAAAGCTAAAAGCCCTTCCA
Chr6:157	GGCCTGGTTAAAATGCACA	GCACTCATCGCTCCAGTTAG
Chr6:642	GCAAAAAGATCCCAGAGGAG	TAGGCCATCAGTGGTCAAAG

**Table S5.** Genotypes of erythroid samples at SNPs surrounding the transcription start of *eNME4* (hg1 chr16:389326:390017).

Samples in bold have skewed expression of *NME4* in erythroid cells.

Sample	rs2071914	rs55976144	rs14293	rs11863625	rs62030825	rs62030826	rs28394836
X18	G/G	C/C	A/G	C/T	C/G	A/G	T/C
X19	G/G	C/C	A/G	C/T	C/G	A/G	T/C
X20	G/G	C/C	A/G	C/T	C/G	A/G	T/C
<b>X21</b>	<b>C/G</b>	<b>C/C</b>	<b>A/G</b>	<b>C/T</b>	<b>G/G</b>	<b>A/A</b>	<b>T/C</b>
<b>X24</b>	<b>C/G</b>	<b>C/C</b>	<b>A/G</b>	<b>C/T</b>	<b>G/G</b>	<b>A/A</b>	<b>T/C</b>
<b>X35</b>	<b>C/G</b>	<b>C/C</b>	<b>A/G</b>	<b>C/T</b>	<b>G/G</b>	<b>A/A</b>	<b>T/C</b>
<b>X36</b>	<b>C/G</b>	<b>C/C</b>	<b>A/G</b>	<b>C/T</b>	<b>G/G</b>	<b>A/A</b>	<b>T/C</b>