

AperTO - Archivio Istituzionale Open Access dell'Università di Torino

CDKN2A and BAP1 germline mutations predispose to melanoma and mesothelioma

This is the author's manuscript

Original Citation:

Availability:

This version is available <http://hdl.handle.net/2318/1562052> since 2020-02-28T15:24:36Z

Published version:

DOI:10.1016/j.canlet.2016.05.011

Terms of use:

Open Access

Anyone can freely access the full text of works made available as "Open Access". Works made available under a Creative Commons license can be used according to the terms and conditions of said license. Use of all other works requires consent of the right holder (author or publisher) if not exempted from copyright protection by the applicable law.

(Article begins on next page)

1 ***CDKN2A* and *BAP1* germline mutations predispose to melanoma and mesothelioma**

2 Betti M¹, Aspesi A¹, Biasi A¹, Casalone E^{2,3}, Ferrante D⁴, Ogliara P⁵, Gironi LC⁶, Giorgione R⁶,
3 Farinelli P⁶, Grosso F⁷, Libener R⁸, Rosato S⁹, Turchetti D¹⁰, Maffè A¹¹, Casadio C¹², Ascoli V¹³,
4 Dianzani C¹⁴, Colombo E⁶, Piccolini E¹⁵, Pavesi M¹⁶, Miccoli S¹⁰, Mirabelli D^{17,18}, Bracco C⁵,
5 Righi L¹⁹, Boldorini R²⁰, Papotti M²¹, Matullo G^{2,3}, Magnani C^{4,18}, Pasini B^{2,5,^}, Dianzani I^{1,18,^,*}

6 ¹Department of Health Sciences, University of Piemonte Orientale, Novara, Italy

7 ²Department of Medical Sciences, University of Turin, Turin, Italy

8 ³Human Genetics Foundation, HuGeF, Turin, Italy

9 ⁴CPO-Piemonte and Unit of Medical Statistics and Epidemiology, Department of Translational Medicine, University of Piemonte
10 Orientale, Novara, Italy

11 ⁵Medical Genetics Unit, AOU Città della Salute e della Scienza, Turin, Italy

12 ⁶Dermatology Clinic, Department of Clinical and Experimental Medicine, University of Piemonte Orientale, Novara, Italy

13 ⁷Division of Medical Oncology, SS. Antonio e Biagio General Hospital, Alessandria, Italy

14 ⁸Pathology Unit, SS. Antonio e Biagio General Hospital, Alessandria, Italy

15 ⁹Department of Obstetric, Gynecologic and Pediatric, Section of Clinical Genetics, Arcispedale S. Maria Nuova-IRCCS, Reggio
16 Emilia, Italy

17 ¹⁰Medical Genetics, Policlinico Sant'Orsola-Malpighi, Bologna, Italy

18 ¹¹Molecular Genetics and Biology Unit, Santa Croce e Carle Hospital, Cuneo, Italy

19 ¹²Thoracic Surgery Unit, Azienda Ospedaliero-Universitaria Maggiore della Carità, Novara, Italy

20 ¹³Department of Radiological, Oncological and Pathological Sciences, Sapienza University, Rome, Italy

21 ¹⁴Department of Dermatology, Campus Biomedico, University of Rome, Rome, Italy

22 ¹⁵Pneumology Unit, Santo Spirito Hospital, Casale Monferrato, Italy

23 ¹⁶Pathological Anatomy Unit, Santo Spirito Hospital, Casale Monferrato, Italy

24 ¹⁷Unit of Cancer Epidemiology, CPO-Piemonte and University of Turin, Turin, Italy

25 ¹⁸Interdepartmental Center for Studies on Asbestos and other Toxic Particulates "G. Scansetti", University of Turin, Turin, Italy

26 ¹⁹Department of Oncology, University of Turin at San Luigi Hospital, Orbassano, Turin, Italy

27 ²⁰Department of Health Sciences, Section of Pathological Anatomy, University of Piemonte Orientale, Novara, Italy

28 ²¹Department of Oncology, University of Turin, AOU Città della Salute e della Scienza di Torino, Turin, Italy

29

30 ^ Barbara Pasini and Irma Dianzani contributed equally to this work.

31

32

33

34

35 *Corresponding author:

36 Irma Dianzani

37 Department of Health Sciences, University of Piemonte Orientale

38 Via Solaroli 17, 28100 Novara, Italy

39 E-mail: irma.dianzani@med.uniupo.it

40

41 **Abstract**

42 *BAP1* germline mutations predispose to a cancer predisposition syndrome that includes
43 mesothelioma, cutaneous melanoma, uveal melanoma and other cancers. This co-occurrence
44 suggests that these tumors share a common carcinogenic pathway. To evaluate this hypothesis, we
45 studied 40 Italian families with mesothelioma and/or melanoma. The probands were sequenced for
46 *BAP1* and for the most common melanoma predisposition genes (i.e. *CDKN2A*, *CDK4*, *TERT*, *MITF*
47 and *POT1*) to investigate if these genes may also confer susceptibility to mesothelioma.

48 In two out of six families with both mesothelioma and melanoma we identified either a germline
49 nonsense mutation (c.1153C>T, p.Arg385*) in *BAP1* or a recurrent pathogenic germline mutation
50 (c.301G>T, p.Gly101Trp) in *CDKN2A*.

51 Our study suggests that *CDKN2A*, in addition to *BAP1*, could be involved in the melanoma and
52 mesothelioma susceptibility, leading to the rare familial cancer syndromes. It also suggests that
53 these tumors share key steps that drive carcinogenesis and that other genes may be involved in
54 inherited predisposition to malignant mesothelioma and melanoma.

55

56

57

58

59

60

61

62

63

64

65

66

67

68

69

70 **1. Introduction**

71 Monogenic cancer predisposition syndromes provide key insights into the complex stepwise
72 mechanisms of carcinogenesis. Identified in 2011, the inherited cancer predisposition syndrome
73 caused by germline mutations in the tumor suppressor gene *BAP1* (BRCA1-Associated Protein 1)
74 has shed light for the first time on monogenic malignant mesothelioma (MM) predisposition [1-6].
75 However, the *BAP1* syndrome spectrum (MIM#614327) includes also other tumors, e.g. cutaneous
76 melanoma (CM), uveal melanoma (UM) [7-18], epithelioid atypical Spitz tumors [19], lung
77 adenocarcinoma, meningiomas [20], neuroendocrine tumors, breast cancer, cholangiocarcinoma,
78 prostate cancer, paraganglioma, renal cell carcinomas [12,21-23] and basal cell carcinoma (BCC)
79 [24-25]. Recently, our group showed an additional tumor type associated with *BAP1*
80 germline mutation, the rare mucoepidermoid carcinoma [26].

81 So far 67 families with the *BAP1* cancer predisposition syndrome and 56 *BAP1* germline mutations
82 have been described [5-6,15-18].

83 More information is needed to ascertain the phenotype of this syndrome, including the evolution of
84 malignant tumors and their response to therapy. Information gained on other cancer-prone
85 syndromes has shown that peculiar response to treatment should influence treatment choice in
86 carriers of germline mutations as compared with sporadic tumors (for example, breast and ovarian
87 cancer due to *BRCA1* and *BRCA2*) [27].

88 Thus, to better characterize the *BAP1* cancer predisposition syndrome, we identified and studied 40
89 Italian families with a suspected predisposition for mesothelioma and/or melanoma. *BAP1* gene was
90 sequenced in a representative subject of each family and the same index cases were also studied for
91 the most common melanoma predisposition genes (i.e. *CDKN2A*, *CDK4*, *TERT*, *MITF*, *POT1*) [28-
92 29] to investigate if these genes may also confer susceptibility to mesothelioma.

93

94 **2. Materials and Methods**

95 *2.1 Probands and Families*

96 We focused only on melanoma and mesothelioma among the *BAP1*-related tumors because
97 of our clinical and epidemiological expertise focused on these tumors.

98 The probands with melanoma were collected from the melanoma databases of the Dermatology
99 Clinic, AOU Maggiore della Carità (Novara), the Medical Genetics Unit, AOU Città della Salute e
100 della Scienza (University of Turin), the Medical Genetics Unit, Policlinico S.Orsola-Malpighi

101 (University of Bologna), the Clinical Genetics Unit of the Department of Obstetric, Gynecologic
102 and Pediatric, Arcispedale S. Maria Nuova (Reggio Emilia) and of the Unit of Dermatology
103 & Plastic Surgery, Campus Biomedico University (Rome).

104 The probands with mesothelioma were collected from the databases of Mesothelioma Biobank
105 (Alessandria), Molecular Genetics and Biology Unit, Santa Croce and Carle Hospital (Cuneo),
106 Thoracic Surgery Unit, AOU Maggiore della Carità (Novara) and Pathology Unit, Sapienza
107 University (Rome).

108 Selection criteria for melanoma patients were the following: diagnosis of melanoma with family
109 history for tumors associated with *BAP1* mutations (i.e. uveal melanoma, mesothelioma, renal cell
110 carcinoma) or juvenile melanoma with family history for melanoma or multiple melanomas with
111 family history for melanoma. Mesothelioma selection criteria were: familial mesothelioma or
112 mesothelioma with family history for *BAP1* associated tumors or melanoma and mesothelioma in
113 the same proband or mesothelioma and other tumors occurring in the same subject.

114 Overall, we identified 40 Italian families classified into three groups (Table I): 6 families with both
115 mesothelioma and melanoma, 23 families with melanoma (without mesothelioma) and with
116 familiarity for *BAP1* associated tumors and 11 families with mesothelioma (without melanoma) and
117 with familiarity for *BAP1* associated tumors. Details on proband's tumors with age at diagnosis and
118 family history are reported in Table I. Pedigrees are shown in Figure 1 (A1,B1,C1) and
119 Supplementary Figure 1 B1. Histological details, asbestos exposure, Fitzpatrick skin phototype and
120 other clinical information are described in Supplementary Table I.

121 All the probands were Caucasian of Italian ancestry and signed an informed consent to participate
122 in the research project.

123

124 *2.2 Histological diagnosis*

125 The diagnosis of melanoma was based on histological and immunochemistry findings.
126 Histological criteria were related to the evaluation of morphological and cytological features;
127 antibodies against Human Melanoma Black-45 (HMB-45), S100 protein and p16 were used in
128 equivocal cases. Melanomas were classified in subtypes, and staged on the basis of the American
129 Joint Committee on Cancer (AJCC) TNM classification (7th edition) [30].

130 The diagnosis of mesothelioma was based on standard histological and
131 immunohistochemical criteria, including positivity to calretinin, vimentin, cytokeratins 5 and 6, and
132 WT1 and negativity to carcinoembryonic antigen, thyroid transcription factor 1 and Ber-EP4. The

133 MMs were classified on the basis of the WHO classification of pleural tumors [31].

134

135 *2.3 Information on asbestos exposure of mesothelioma patients*

136 Since asbestos exposure is the main risk factor for MM [32], it was carefully evaluated in all
137 MM probands. Information on asbestos exposure at work, at home and in the general environment
138 for index cases included in the Malignant Mesothelioma Registry of the Piedmont Region (RMM)
139 was collected by RMM using a standardized questionnaire [33], that was administered by trained
140 interviewers. For familial cases identified in the proband's pedigree, information was gathered from
141 their attending clinician's reports, clinical records and data included in the RMM. Information was
142 collected during the personal interview of the proband if available. Asbestos exposure was
143 classified as: high exposure, low exposure, no exposure, unknown exposure. Details are reported in
144 Betti et al. 2015 [26].

145

146 *2.4 Information on risk factors of melanoma probands*

147 The role of UV exposure is well known in the development of melanoma. People with pale
148 skin are at higher risk for this tumor. Dysplastic and/or melanocytic nevi are considered
149 premalignant lesions in melanoma carcinogenesis [34]. Thus, the professional or chronic UV
150 exposure, the occurrence of dysplastic and/or melanocytic nevi and Fitzpatrick skin phototype were
151 evaluated in melanoma probands.

152

153 *2.5 DNA extraction and Sequencing analyses*

154 Blood samples were collected in vacutainers with ethylenediaminetetraacetic acid (EDTA)
155 and stored at -20°C until use. Genomic DNA was extracted from peripheral blood using QIAamp®
156 DNA Blood Maxi Kit (QIAGEN, Valencia, CA, USA), according to the manufacturer's protocol.

157 The 17 exons, intron-exon boundaries and promoter region (~1000bp upstream of the ATG)
158 of *BAP1* (NM_004656.2), the exons and intron-exon boundaries of *CDKN2A* (NM_000077.4), the
159 exon 2 of *CDK4* (NM_000075.3), the promoter of *TERT* (NM_198253.2), the missense variant
160 p.Glu318Lys of *MITF* (NM_000248.3) and the exon 10 of *POT1* (NM_015450) were amplified.
161 The primers were designed using the reference sequences provided by NCBI or Ensembl databases
162 (Supplementary Table II).

163 PCR reactions were performed in a 25 μ L volume using GoTaq[®] Flexi Polymerase
164 (PROMEGA, Madison, WI, USA) for *BAP1* fragments amplification and Taq Gold 360+GC
165 enhancer for fragments amplification of melanoma predisposition genes. Sanger sequencing was
166 done using ABI PRISM 3130xl Genetic Analyzer or by IGA Technology Services (Udine, Italy).
167 Sequences were read by aligning with the reference sequence, using the GENESTREAM II Align
168 tool.

169 Each variant was confirmed on DNA obtained from a second independent blood vial.
170 Segregation analysis of three variants was done on DNA extracted from blood samples or tumor
171 FFPE of key relatives.

172

173 *2.6 Loss-of-heterozygosity analysis*

174 To assess *loss-of-heterozygosity (LOH)*, we performed Sanger sequencing and microsatellite
175 analysis on DNA obtained from tumor portions of FFPE (Formalin-fixed paraffin-embedded)
176 biopsy specimens. For each sample three serial 10 μ m thick sections were cut using microtome. The
177 slides were heated at 60°C for 30 min. The paraffin-embedded tissues were processed with xylene
178 and absolute ethanol. Deparaffinized tissues were scraped from the slides and placed in 1.5 ml-
179 Eppendorf tubes. DNA was purified using QIAamp[®] DNA FFPE Tissue Kit (QIAGEN, Valencia,
180 CA, USA) according to the manufacturer's protocol.

181 Sanger sequencing of the mutated region was then performed. LOH was indicated by loss of the
182 wild type allele in the mutation site.

183 Microsatellite analysis was performed using three markers (D3S3026, D3S3561 and D3S1578)
184 flanking the *BAP1* gene [20]. The analysis was carried out on genomic and tumor DNAs. Amplified
185 PCR products were separated with ABI 3130xl Genetic Analyzer and fragments were analyzed
186 using GeneMapper. LOH was indicated by apparent homozygosity at the microsatellite sites.

187

188 *2.7 Immunohistochemistry analysis*

189 To ascertain the role of germline *BAP1* or *CDKN2A* mutations, protein expression was evaluated
190 by immunohistochemistry (IHC) using a standard automated immunostainer (BenchMark,
191 Ventana Medical System, Tucson AZ).

192 Specific primary antibody against the anti-human BAP1 (mouse monoclonal, clone C-4, Santa
193 Cruz Biotechnology, Inc., Santa Cruz, CA) and anti-p16^{INK4a} (mouse monoclonal, CLONE E6H4,
194 Ventana Medical System, Tucson, AZ) were used, respectively.

195 BAP1 was considered positive when a weak-to-strong nuclear positivity was shown. The specificity
196 of BAP1 stain was validated in serial negative control sections by omitting the primary antibody for
197 each immunohistochemical run. Non-neoplastic cells, such as vascular endothelium or
198 inflammatory cells, were considered as internal positive controls.

199 To detect the p16 protein, every tumor was given a score according to the intensity of the nuclear or
200 cytoplasmic staining (no staining; weak staining; moderate staining; strong staining). A stained
201 slide with a high-degree intraepithelial lesion of the uterine cervix was used as a positive control.

202

203 *2.8 In silico prediction analyses*

204 Pathogenicity assessment of missense variants is an important problem in cancer
205 predisposition syndrome [35].

206 To address the problem concerning *BAP1* missense variants, we have considered the following
207 parameters: results of LOH assay, results of IHC, frequency in 1000 Genomes Project and ExAC
208 databases, disease-causing potential using seven different prediction tools (Mutation taster, SIFT,
209 Provean, Polyphen-2, Mutation assessor, Condel, Phyre2), segregation analysis.

210 Since a change in a coding sequence may activate a cryptic splice site, we have also evaluated
211 splice site prediction using seven different tools (Human Splicing Finder, MaxEnt, BDGP,
212 NetGene2, GeneScan, FGENESH 2.6, FSPLICE 1.0).

213 As controls for the prediction programs, we used the five most frequent missense variants in ExAC,
214 (these variants are expected to be silent changes, since they are commonly found in normal
215 individuals).

216 We considered LOH, IHC or splice site prediction as the most important parameters. If LOH and
217 IHC data were not available, we considered as pathogenic a missense variant that has a disease
218 causing potential for at least 5/7 tools.

219 Segregation should be evaluated taking into consideration that frequent cancers may also occur as
220 phenocopies, i.e. patient with cancer but without the mutation identified in other affected family
221 members. Phenocopies are events not so rare in inherited cancer predisposition syndromes.

222

223 *2.9 Multiplex Ligation-dependent Probe Amplification (MLPA)*

224 MLPA was used to evaluate the presence of copy number variations. MLPA assays were
225 performed on 100-200ng of genomic DNAs using the SALSA MLPA P417 BAP1 probemix and
226 the SALSA MLPA probemix P419-A1 CDKN2A/2B-CDK4 Melanoma according to instructions

227 provided by the manufacturer (MRC-Holland, Amsterdam, The Netherlands). Amplified PCR
228 products were separated with ABI 3130xl Genetic Analyzer and fragments were analyzed using
229 Coffalyser.NET software (MRC-Holland).

230

231 **3. Results**

232 *3.1 Risk factors*

233 Information on asbestos exposure was available for 10 out of 12 mesothelioma probands
234 (Supplementary Table I). All of them showed asbestos exposure, in agreement with literature [32].
235 Possible occupational exposure was reported for four probands, para-occupational or household
236 exposure for five patients and both possible occupational and household exposure for one proband.

237 One out of 28 melanoma probands showed professional or chronic UV exposure.
238 Information regarding Fitzpatrick skin phototype was available for 16 out of 28 probands: one had
239 phototype I, 10 had phototype II and 5 had phototype III. Information about dysplastic and/or
240 melanocytic nevi was available for 13 patients. Whereas one proband showed dysplastic nevi, 13
241 showed melanocytic nevi (7 probands <10, 2 probands 10-50, 4 probands >50). In total, 17 out of
242 28 probands showed at least well-documented risk factor (Supplementary Table I). Even if
243 information is lacking for 11 probands, our data confirms the high occurrence of well-documented
244 risk factors in melanoma patients [34].

245

246 *3.2 Mutation analysis*

247 Among the 40 probands with a family history of cancer we identified four *BAP1* germline
248 variants and a recurrent pathogenic germline mutation in *CDKN2A* in three and one index cases,
249 respectively (Table I).

250 Two *BAP1* and one *CDKN2A* germline variants were found in families with both
251 mesothelioma and melanoma. Two other *BAP1* germline variants were identified in a patient with
252 multiple cutaneous amelanotic melanomas (Table I).

253 The proband of family ID5 carried a heterozygous nonsense mutation in *BAP1* gene
254 (c.1153C>T, p.Arg385*, exon 12) (II-4 PB, Figure 1 A2). The mutation seemed heterozygous also
255 in the tumor samples (II-4 CM, II-4 MM, Figure 1 A2) and microsatellite analysis did not reveal
256 evidence of LOH (data not shown). However, IHC did not reveal any BAP1 nuclear expression in
257 both melanoma and mesothelioma cells (II-4 CM, II-4 MM, Figure 1A3). It is thus possible that the
258 second inactivating “hit” was either a somatic point mutation or a methylation event. This mutation

259 has been previously reported in three families with Spitz tumors and ocular and cutaneous
260 melanoma [8,14], but this is the first report in association with MM. The proband developed two
261 independent cutaneous melanomas (53, 57yrs), a meningioma (37yrs) and an epithelioid pleural
262 mesothelioma (53yrs) (Figure 1 A1, Table I). The mutation was transmitted to the proband's
263 healthy daughter (III-2 PB, Figure 1 A2) while the proband's brother died because of a basal cell
264 carcinoma, but no sample was available for segregation analysis.

265 The proband of melanoma family ID16 developed two cutaneous amelanotic melanomas and
266 showed a *BAP1* missense variant (c.1700A>C, p.Asp567Ala, exon 13) (IV-1 PB, Figure 1 B2) and
267 a 5bp duplication in the promoter region (c.-594dupCCCGT) (IV-1 PB, Supplementary Figure 1
268 A1). Sequencing analysis of both parents confirmed that these variants were inherited *in cis* from
269 the mother (III-5 PB, Figure 1 B2 and Supplementary Figure 1 A1), who presented with a non-
270 Hodgkin cutaneous lymphoma. A healthy maternal aunt and a proband's healthy sister were also
271 carriers (III-6 PB, IV-2 PB respectively, Figure 1 B2 and Supplementary Figure 1 A1). On the other
272 hand, the proband's healthy father and the paternal uncle affected by cutaneous melanoma did not
273 carry the variant allele. Thus, the cutaneous pigmented melanoma presented by the proband's
274 paternal uncle was not due to the aforementioned *BAP1* germline variants.

275 The missense variant appeared in heterozygous state also in the two melanomas from the proband
276 (IV-1 CM_1, IV-1 CM_2, Figure 1 B2).

277 Microsatellites analysis, performed on genomic and tumor DNAs, showed a decreased amount of
278 the shorter paternal allele for the only informative marker (D3S3026) (IV-1 CM_1, IV-1 CM_2,
279 Figure 1 B3). Considering a stromal cell contamination of tumor DNA from melanoma samples
280 (determined as 64% in average, 15-90%) [36], this result suggests the loss of the wild type allele
281 (LOH).

282 The presence of BAP1 protein was ascertained by IHC on FFPE pertaining to the two different
283 melanomas from the proband (IV-1 CM_1, IV-1 CM_2, Figure 1 B4). BAP1 was normally
284 expressed in the nucleus, showing that both the promoter duplication and the missense variant do
285 not drastically affect protein levels. Since IHC is not quantitative, this result does not conflict with a
286 tumor genotype that includes an expressed allele with a missense variant and a somatic deletion that
287 abolishes the expression of the wild type protein.

288 To assess the pathogenicity of this missense variant, we have compared the p.Asp567Ala
289 with all the eleven *BAP1* missense variants reported so far in patients with familiarity for *BAP1*

290 associated tumors (Supplementary Table III) using the parameters reported in the Materials and
291 Methods section.

292 Using these parameters, 7/12 variants could be considered as disease causing. Two of them are
293 predicted to cause aberrant splicing. One of these was experimentally confirmed [21], the second
294 was not tested by the authors [6]. The other missense variants should be considered as *variant of*
295 *unknown significance* (VUS), including p.Asp567Ala.

296 We have also performed a prediction of the three dimensional structure of the variant protein
297 according to Protein Homology/analogy Recognition Engine v.2 (Phyre2). The mutant hydrophobic
298 Ala567 is predicted to be buried within the globular portion of the protein and the relevant domains
299 of the BAP1 protein seem to assume a different position (Supplementary Figure 2).

300 In conclusion, a functional assay is strongly needed to assess the pathogenicity of missense variants
301 including p.Asp567Ala.

302 The duplication in the promoter was predicted to remove a MAZ (MYC-Associated Zinc Finger
303 Protein) binding site by PROMO (TRANSFAC), but has no effect on transcription factor binding
304 by AliBaba 2.1. The duplication is not reported in public databases (NCBI dbSNPs, 1000 Genomes
305 Project phase 3, Exome Variant Server, Exome Aggregation Consortium at march 2015). Thus,
306 considering that the protein is expressed, our data overall suggest that the duplication is a likely
307 neutral variant.

308 The proband of family ID4 showed a heterozygote 19bp duplication (c.-
309 247dupCCTTCGCCCCCGTCCCTCC) in the *BAP1* promoter region (II-1 PB, Supplementary
310 Figure 1 B2) not reported in the above mentioned databases. This variant is predicted to generate an
311 ETF binding site by AliBaba 2.1, but has no effect on transcription factor binding site by PROMO
312 (TRANSFAC). IHC performed on the mesothelioma tissue showed nuclear expression of BAP1
313 protein (data not shown), supporting the hypothesis that this variant does not significantly alter gene
314 transcription and could be considered as VUS. This family included both melanoma and MM in its
315 tumor spectrum, but additional specimens were not available for further studies.

316 Probands from the other families were analyzed using the same strategy, but no other
317 germline variant was found in *BAP1* gene.

318 Conversely, a recurrent pathogenic germline mutation (c.301G>T, p.Gly101Trp, exon 2) in
319 *CDKN2A* was found in the family ID3 showing both melanoma and mesothelioma. The *CDKN2A*
320 germline mutation was carried by the proband affected by cutaneous melanoma and by her mother
321 affected by both cutaneous melanoma and mesothelioma (III-3 PB, II-3 FFPE non-tumor tissue

322 respectively, Figure 1 C2). This mutation was found in heterozygosity with the wild type sequence
323 also in mesothelioma from the proband's mother (II-3 MM, Figure 1 C2).

324 Mesothelioma cells showed nuclear staining at IHC with anti-p16 antibody (II-3 MM, Figure 1 C3)
325 although the intensity of nuclear expression was slightly lower in less differentiated tumor cells.

326 MLPA analysis was performed on germline DNA from all the probands, but no copy
327 number variations has been identified.

328 The probands from the other families under study were sequenced for the most common
329 melanoma predisposition genes (*CDKN2A*, *CDK4* exon 2, *TERT* promoter, *MITF* exon 9, *POT1*
330 exon 10), but no additional germline variant was found. Details of the results for each proband are
331 reported in Table 1.

332

333 4. Discussion

334 Malignant mesothelioma is a rare and aggressive tumor that mainly arise from the pleura
335 and the peritoneum. The main risk factor is asbestos exposure [32]. Over 80% of MM patients have
336 a history of asbestos exposure, but only 10-17% of individuals heavily exposed to asbestos develop
337 MM [37]. Moreover, several families with multiples cases of MM have been described [38-41].
338 These observations suggest the involvement of inherited factors in the pathogenesis of MM. A
339 single high penetrance MM predisposition gene, *BAP1*, has been so far reported in familial cases of
340 MM [1]. Previous observations from our group and other researchers [26,42-43] limit the role of the
341 *BAP1* predisposition to the familial cases, as the mutation detection rate among sporadic cases
342 showing the mutations is less than 2% [26].

343 Cutaneous melanoma (CM) and uveal melanoma (UM) are also aggressive tumors that
344 originate from melanocytes of the skin and the eye, respectively. CM is responsible for 75% of
345 deaths from skin cancer [34] whereas UM accounts for less than 4% of all melanoma cases [44].
346 Although UV radiations are a well known environmental risk factor, 10% of melanomas are familial
347 regardless sun exposure or skin phototype. A subset of families (50%) carries mutations in one of
348 the known high penetrance melanoma predisposition genes: *CDKN2A*, *CDK4*, *POT1*, *TERT*, *MITF*
349 and *BAP1* [45].

350 Thus, germline mutations in *BAP1* are thought to be responsible for both MM and familial
351 melanoma. Within the 67 families identified so far as affected by this syndrome, 18 showed both
352 melanoma and mesothelioma [5-6,15-18]. Interestingly, six families from our series included
353 patients with mesothelioma and melanoma.

354 To better characterize the *BAP1* cancer syndrome we sequenced *BAP1* in 40 Italian families
355 in which multiple cases of either MM or melanoma, or cases of both malignancies occurred.
356 Moreover, we reasoned that given the shared predisposition for these tumors due to *BAP1*, other
357 genes predisposing to melanoma could also predispose to MM. Thus, we also analysed *CDKN2A*,
358 *CDK4*, *TERT*, *MITF* and *POT1* in the MM families.

359 We identified a germline *BAP1* truncating mutation (c.1153C>T, p.Arg385*) in a patient
360 who developed both MM and melanoma (Family ID5). This nonsense mutation has been previously
361 identified in three families with familial melanoma [8,14], but never in MM. This patient is still
362 alive five years after the diagnosis of epithelioid MM and was not heavily exposed to asbestos.
363 Epithelioid histology, long survival and low asbestos exposure have all been described in patients
364 with MM carrying germline *BAP1* mutations [1,46-48]. Further studies are needed to ascertain
365 whether these aspects are typical of the *BAP1* cancer syndrome. However, it is possible that studies
366 on familial predispositions are biased towards an over representation of long-survivors while short
367 survival might hamper sample collection and proper investigation.

368 A further patient (Family ID4), whose father died of MM, developed cutaneous melanoma
369 and breast cancer and carried a germline 19bp duplication in *BAP1* promoter region (c.-247dup
370 CCTTCGCCCCCGTCCCTCC). This VUS is not included in public databases, but could not be
371 traced in segregation analysis because key relatives were not available.

372 Our study also stresses the need of a reliable functional assay to evaluate the pathogenicity
373 of missense variants. In fact, the use of multiple *in silico* prediction tools did not allow to assess the
374 pathogenicity of the p.Asp567Ala variant found in a patient with multiple melanomas (family
375 ID16).

376 Finally, looking for mutations in the familial melanoma genes we found a germline
377 *CDKN2A* mutation in family ID3 (c.301G>T, p.Gly101Trp). This mutation has been frequently
378 identified in familial melanoma (44%) [49]. The proband was diagnosed with cutaneous melanoma,
379 whereas her mother had both cutaneous melanoma and MM. Mesothelioma tissue of the proband's
380 mother showed p16 nuclear expression. A retained p16 expression for this mutation is reported in
381 literature for melanoma [50]. Ghiorzo et al., reported that 28 out of 30 Gly101Trp-positive
382 melanoma samples retained p16 expression and in 25 of these, p16 expression was predominantly
383 nuclear.

384 Asbestos exposure at work of the proband's mother was assessed as 'low exposure', a
385 category including all occupational exposures occurring outside industries where asbestos was
386 directly used as a raw material.

387 Patients with *BAP1* mutations seem to develop mesothelioma even after a low asbestos
388 exposure [1]. Our finding suggests that the *CDKN2A* p.Gly101Trp behaves as *BAP1* mutations: the
389 mutation carrier is at high risk for tumors and the type of carcinogen exposure is important for the
390 cancer type that is developed. In conclusion, our study suggests for the first time that also *CDKN2A*
391 may predispose to MM.

392 Although the coincidence of two rare tumors in a single patient promptly suggests a
393 common origin, we cannot exclude the independent occurrence of a malignant mesothelioma in a
394 patient otherwise predisposed to melanoma. Indeed, we failed to identify additional *CDKN2A*
395 germline mutations in our series but the same is true for *BAP1* whose mutations are very rare and do
396 not explain most familial clustering of tumors investigated in this work, as well as cases or families
397 with both melanoma and renal cell cancer.

398 Both *BAP1* and *CDKN2A* genes are found somatically deleted or mutated in MM tissues
399 [51]. This study further supports that loss of either *BAP1* or *CDKN2A* is an important step in both
400 melanoma and MM carcinogenesis and individuals that carry a germline mutation in either of these
401 two genes might have an increased risk for both tumors.

402 Three other families (IDs 1,2,6) showed co-occurrence of MM and melanoma. The fact that
403 none of these families showed germline mutations in either *BAP1* or *CDKN2A*, *CDK4*, *TERT*, *MITF*
404 and *POT1* suggests that other genes may be involved in melanoma and MM shared predisposition.
405 Other cancer predisposition syndromes have been reportedly associated with both tumors. Patients
406 with Li Fraumeni syndrome due to *TP53* mutations frequently develop melanoma [52-53], more
407 rarely MM [54]. Moreover, the occurrence of both melanoma and mesothelioma has been reported
408 in a patient with neurofibromatosis type 2, due to heterozygous germline mutations in *NF2* [55-57].
409 Both *TP53* and *NF2* are often somatically deleted in MM. Thus, at least four genes that cause
410 inherited cancer predisposition syndromes, including MM and melanoma in their spectrum, are
411 often subjected to inactivating somatic mutations or deletions both in melanoma and MM [7,58-59].
412 An occurrence of MM as a second tumor after melanoma was reported two-fold more frequently
413 than expected ($p < 0.05$, in males) in a recent survey performed on Italian cancer registries [60]. A
414 genetic susceptibility may explain the statistically significant co-occurrence of the two tumors in the
415 same individual.

416 A common denominator between mesothelioma and melanoma is also the well-defined role of
417 environmental carcinogens. In mice, germline *Bap1* mutations increase the susceptibility to
418 asbestos-induced mesothelioma formation [61] and *BAP1* mutation carriers may be prone to UV
419 carcinogenesis and melanoma development [5].

420 Our study suggests that *CDKN2A*, in addition to *BAP1*, could be involved in melanoma and
421 mesothelioma susceptibility and these tumors share key steps that drive carcinogenesis and may
422 cause familial aggregations of cases. Our hypothesis should be confirmed on a larger patients serie.
423 Our study also suggests that other unknown genes may be involved in familial MM or familial
424 melanoma, including uveal melanoma. Exome-sequencing analysis in families that show both MM
425 and melanoma could help to identify new genes involved in the shared susceptibility between these
426 tumors.

427

428 **Acknowledgments**

429 We wish to thank all of the patients who generously participated to this study, Dr. Guido Casalis
430 Cavalchini for contributing cases to this series, Prof. Emanuele Albano for helpful discussion, and
431 Ms. Victoria Franzinetti for the careful revision of the text.

432 This study was supported by Istituto Superiore di Sanità (Progetto Amianto) (to C. Magnani in
433 collaboration with I. Dianzani), HuGeF, Compagnia di San Paolo and AIRC (IG 174646) (to G.
434 Matullo).

435

436 **References**

- 437 [1] Testa JR, Cheung M, Pei J, Below JE, Tan Y, Sementino E, Cox NJ, Dogan AU, Pass HI, Trusa S, Hesdorffer M,
438 Nasu M, Powers A, Rivera Z, Comertpay S, Tanji M, Gaudino G, Yang H, Carbone M. 2011. Germline BAP1
439 mutations predispose to malignant mesothelioma. *Nat Genet* 43(10):1022-5. doi: 10.1038/ng.912.
- 440 [2] Wiesner T, Fried I, Ulz P, Stacher E, Popper H, Murali R, Kutzner H, Lax S, Smolle-Juttner F, Geigl JB, Speicher
441 MR. 2012. Toward an improved definition of the tumor spectrum associated with BAP1 germline mutations. *J Clin*
442 *Oncol* 30(32):e337-40. doi: 10.1200/JCO.2011.41.2965.
- 443 [3] Ribeiro C, Campelos S, Moura CS, Machado JC, Justino A, Parente B. 2013. Well-differentiated papillary
444 mesothelioma: clustering in a Portuguese family with a germline BAP1 mutation. *Ann Oncol* 24:2147-50. doi:
445 10.1093/annonc/mdt135.
- 446 [4] Cheung M, Talarchek J, Schindeler K, Saraiva E, Penney LS, Ludman M, Testa JR. 2013. Further evidence for
447 germline BAP1 mutations predisposing to melanoma and malignant mesothelioma. *Cancer Genet* 206:206-10. doi:
448 10.1016/j.cancergen.2013.05.018.
- 449 [5] Cheung M, Kadariya Y, Talarchek J, Pei J, Ohar JA, Kayaleh OR, Testa JR. 2015. Germline BAP1 mutation in a
450 family with high incidence of multiple primary cancers and a potential gene-environment interaction. *Cancer*
451 *Lett* 369(2):261-5. doi: 10.1016/j.canlet.2015.09.011.
- 452 [6] Ohar JA, Cheung M, Talarchek J, Howard SE, Howard TD, Hesdorffer M, Peng H, Rauscher FJ, Testa JR. 2016.
453 Germline BAP1 Mutational Landscape of Asbestos-Exposed Malignant Mesothelioma Patients with Family History of
454 Cancer. *Cancer Res* 76(2):206-15. doi: 10.1158/0008-5472.CAN-15-0295.
- 455 [7] Wiesner T, Obenaus AC, Murali R, Fried I, Griewank KG, Ulz P, Windpassinger C, Wackernagel W, Loy S, Wolf I,
456 Viale A, Lash AE, Pirun M, Socci ND, Rütten A, Palmedo G, Abramson D, Offit K, Ott A, Becker JC, Cerroni L,
457 Kutzner H, Bastian BC, Speicher MR. 2011. Germline mutations in BAP1 predispose to melanocytic tumors. *Nat Genet*
458 43(10):1018-21. doi: 10.1038/ng.910.
- 459 [8] Njauw CN, Kim I, Piris A, Gabree M, Taylor M, Lane AM, DeAngelis MM, Gragoudas E, Duncan LM, Tsao H.
460 2012. Germline BAP1 inactivation is preferentially associated with metastatic ocular melanoma and cutaneous-ocular
461 melanoma families. *PLoS One* 7:e35295. doi: 10.1371/journal.pone.0035295.
- 462 [9] Aoude LG, Wadt K, Bojesen A, Crüger D, Borg A, Trent JM, Brown KM, Gerdes AM, Jönsson G, Hayward NK.

463 2013. A BAP1 Mutation in a Danish Family Predisposes to Uveal Melanoma and Other Cancers. *PloS One* 8:e72144.
464 doi: 10.1371/journal.pone.0072144.

465 [10] Hoiom V, Edsgard D, Helgadottir H, Eriksson H, All-Ericsson C, Tuominen R, Ivanova I, Lundeberg J,
466 Emanuelsson O, Hansson J. 2013. Hereditary uveal melanoma: A report of a germline mutation in BAP1. *Genes*
467 *Chromosomes Cancer* 52(4):378-84. doi: 10.1002/gcc.22035.

468 [11] Maerker DA, Zeschnick M, Nelles J, Lohmann DR, Worm K, Bosserhoff AK, Krupar R, Jäggle H. 2014. BAP1
469 germline mutation in two first grade family members with uveal melanoma. *Br J Ophthalmol* 98:224-227. doi:
470 10.1136/bjophthalmol-2013-303814.

471 [12] Pilarski R, Cebulla CM, Massengill JB, Rai K, Rich T, Strong L, McGillivray B, Asrat MJ, Davidorf FH, Abdel-
472 Rahman MH. 2014. Expanding the clinical phenotype of hereditary BAP1 cancer predisposition syndrome, reporting
473 three new cases. *Genes Chromosomes Cancer* 53(2):177-82. doi: 10.1002/gcc.22129.

474 [13] Cebulla CM, Binkley EM, Pilarski R, Massengill JB, Rai K, Liebner DA, Marino MJ, Singh AD, Abdel-Rahman
475 MH. 2015. Analysis of BAP1 Germline Gene Mutation in Young Uveal Melanoma Patients. *Ophthalmic Genet*
476 36(2):126-31. doi: 10.3109/13816810.2015.1010734.

477 [14] Gupta MP, Lane AM, DeAngelis MM, Mayne K, Crabtree M, Gragoudas ES, Kim IK. 2015. Clinical
478 Characteristics of Uveal Melanoma in Patients With Germline BAP1 Mutations. *JAMA Ophthalmol* 133(8):881-7. doi:
479 10.1001/jamaophthalmol.2015.1119.

480 [15] Gerami P, Yélamos O, Lee CY, Obregon R, Yazdan P, Sholl LM, Guitart GE, Njauw CN, Tsao H. 2015. Multiple
481 Cutaneous Melanomas and Clinically Atypical Moles in a Patient With a Novel Germline BAP1 Mutation. *JAMA*
482 *Dermatol* 151(11):1235-9. doi: 10.1001/jamadermatol.2015.1701.

483 [16] Rai K, Pilarski R, Cebulla CM, Abdel-Rahman MH. 2016. Comprehensive review of BAP1 tumor predisposition
484 syndrome with report of two new cases. *Clin Genet* 89(3):285-94. doi: 10.1111/cge.12630.

485 [17] Klebe S, Driml J, Nasu M, Pastorino S, Zangiabadi A, Henderson D, Carbone M. 2015. BAP1 hereditary cancer
486 predisposition syndrome: a case report and review of literature. *Biomark Res* 3:14. doi: 10.1186/s40364-015-0040-5.

487 [18] McDonnell KJ, Gallanis GT, Heller KA, Melas M, Idos GE, Culver JO, Martin SE, Peng DH, Gruber SB. 2016. A
488 novel BAP1 mutation is associated with melanocytic neoplasms and thyroid cancer. *Cancer Genet* 209(3):75-81. doi:
489 10.1016/j.cancergen.2015.12.007.

490 [19] Busam KJ, Wanna M, Wiesner T. Multiple epithelioid Spitz nevi or tumors with loss of BAP1 expression: a clue to
491 a hereditary tumor syndrome. *JAMA Dermatol.* 2013 Mar;149(3):335-9. doi: 10.1001/jamadermatol.2013.1529.

492 [20] Abdel-Rahman MH, Pilarski R, Cebulla CM, Massengill JB, Christopher BN, Boru G, Hovland P, Davidorf FH.
493 2011. Germline BAP1 mutation predisposes to uveal melanoma, lung adenocarcinoma, meningioma, and other cancers.
494 *J Med Genet* 48(12):856-9. doi: 10.1136/jmedgenet-2011-100156.

495 [21] Wadt K, Choi J, Chung JY, Kiilgaard J, Heegaard S, Drzewiecki KT, Trent JM, Hewitt SM, Hayward NK, Gerdes
496 AM, Brown KM. 2012. A cryptic BAP1 splice mutation in a family with uveal and cutaneous melanoma, and
497 paraganglioma. *Pigment Cell Melanoma Res* 25(6):815-8.

498 [22] Popova T, Hebert L, Jacquemin V, Gad S, Caux-Moncoutier V, Dubois-d'Enghien C, Richaudeau B, Renaudin X,
499 Sellers J, Nicolas A, Sastre-Garau X, Desjardins L, Gyapay G, Raynal V, Similnikova OM, Andrieu N, Manié E, de
500 Pauw A, Gesta P, Bonadona V, Maugard CM, Penet C, Avril MF, Barillot E, Cabaret O, Delattre O, Richard S, Caron
501 O, Benfodda M, Hu HH, Soufir N, Bressac-de Paillerets B, Stoppa-Lyonnet D, Stern MH. 2013. Germline BAP1
502 Mutations Predispose to Renal Cell Carcinomas. *Am J Hum Genet* 92:974-980. doi: 10.1016/j.ajhg.2013.04.012.

503 [23] Farley MN, Schmidt LS, Mester JL, Peña-Llopis S, Pavia-Jimenez A, Christie A, Vocke CD, Ricketts CJ, Peterson
504 J, Middleton L, Kinch L, Grishin N, Merino MJ, Metwalli AR, Xing C, Xie XJ, Dahia PL, Eng C, Linehan WM,
505 Brugarolas J. 2013. A novel germline mutation in BAP1 predisposes to familial clear-cell renal cell carcinoma. *Mol*
506 *Cancer Res* 11(9):1061-71. doi: 10.1158/1541-7786.MCR-13-0111.

507 [24] Wadt KA, Aoude LG, Johansson P, Solinas A, Pritchard A, Crainic O, Andersen MT, Kiilgaard JF, Heegaard S,
508 Sunde L, Federspiel B, Madore J, Thompson JF, McCarthy SW, Goodwin A, Tsao H, Jönsson G, Busam K, Gupta R,
509 Trent JM, Gerdes AM, Brown KM, Scolyer RA, Hayward NK. 2015. A recurrent germline BAP1 mutation and
510 extension of the BAP1 tumor predisposition spectrum to include basal cell carcinoma. *Clin Genet* 88(3):267-72. doi:
511 10.1111/cge.12501.

512 [25] de la Fouchardière A, Cabaret O, Savin L, Combemale P, Schwartz H, Penet C, Bonadona V, Soufir N, Bressac-de
513 Paillerets B. 2015. Germline BAP1 mutations predispose also to multiple basal cell carcinomas. *Clin Genet* 88(3):273-
514 7. doi: 10.1111/cge.12472.

515 [26] Betti M, Casalone E, Ferrante D, Romanelli A, Grosso F, Guarrera S, Righi L, Vatrano S, Pelosi G, Libener R,
516 Mirabelli D, Boldorini R, Casadio C, Papotti M, Matullo G, Magnani C, Dianzani I. 2015. Inference on germline BAP1
517 mutations and asbestos exposure from the analysis of familial and sporadic mesothelioma in a high-risk area. *Genes*
518 *Chromosomes Cancer* 54(1):51-62. doi: 10.1002/gcc.22218.

519 [27] Moreno L, Linossi C, Esteban I, Gadea N, Carrasco E, Bonache S, Gutiérrez-Enríquez S, Cruz C, Díez O, Balmaña
520 J. Germline BRCA testing is moving from cancer risk assessment to a predictive biomarker for targeting cancer
521 therapeutics. *Clin Transl Oncol*. 2016 Jan 7.

522 [28] Hill VK, Gartner JJ, Samuels Y, Goldstein AM. 2013. The genetics of melanoma: recent advances. *Annu Rev*
523 *Genomics Hum Genet* 14:257-79. doi: 10.1146/annurev-genom-091212-153429.

524 [29] Shi J, Yang XR, Ballew B, Rotunno M, Calista D, Fargnoli MC, Ghiorzo P, Bressac-de Paillerets B, Nagore E,
525 Avril MF, Caporaso NE, McMaster ML, Cullen M, Wang Z, Zhang X; NCI DCEG Cancer Sequencing Working
526 Group; NCI DCEG Cancer Genomics Research Laboratory; French Familial Melanoma Study Group, Bruno W5,
527 Pastorino L, Queirolo P, Banuls-Roca J, Garcia-Casado Z, Vaysse A, Mohamdi H, Riazalhosseini Y, Foglio M, Jouenne
528 F, Hua X, Hyland PL, Yin J, Vallabhaneni H, Chai W, Minghetti P, Pellegrini C, Ravichandran S, Eggermont A,
529 Lathrop M, Peris K, Scarra GB, Landi G, Savage SA, Sampson JN, He J, Yeager M, Goldin LR, Demenais F, Chanock
530 SJ, Tucker MA, Goldstein AM, Liu Y, Landi MT. 2014. Rare missense variants in POT1 predispose to familial
531 cutaneous malignant melanoma. *Nat Genet* 46(5):482-6. doi: 10.1038/ng.2941.

532 [30] Edge SB, Compton CC. 2010. The American Joint Committee on Cancer: the 7th edition of the AJCC cancer
533 staging manual and the future of TNM. *Ann SurgOncol* 17(6):1471-4. doi: 10.1245/s10434-010-0985-4.

534 [31] Travis WD, Brambilla E, Burke AP, Marx A, Nicholson AG. 2015. Introduction to The 2015 World Health
535 Organization Classification of Tumors of the Lung, Pleura, Thymus, and Heart. *JThoracOncol* 10(9):1240-2. doi:
536 10.1097/JTO.0000000000000663.

537 [32] Pinto C, Novello S, Torri V, Ardizzoni A, Betta PG, Bertazzi PA, Casalini GA, Fava C, Fubini B, Magnani C,
538 Mirabelli D, Papotti M, Ricardi U, Rocco G, Pastorino U, Tassi G, Trodella L, Zompatori M, Scagliotti G. 2013.
539 Second Italian consensus conference on malignant pleural mesothelioma: state of the art and recommendations. *Cancer*
540 *Treat Rev* 39(4):328-39. doi: 10.1016/j.ctrv.2012.11.004.

541 [33] Magnani C, Agudo A, González CA, Andrion A, Calleja A, Chellini E, Dalmaso P, Escolar A, Hernandez S,
542 Ivaldi C, Mirabelli D, Ramirez J, Turuguet D, Usel M, Terracini B. 2000. Multicentric study on malignant pleural
543 mesothelioma and non-occupational exposure to asbestos. *British Journal of Cancer*. 83, 104–11.

544 [34] Potrony M, Badenas C, Aguilera P, Puig-Butille JA, Carrera C, Malveyh J, Puig S. 2015. Update in genetic
545 susceptibility in melanoma. *Ann Transl Med* 3(15):210. Review. doi: 10.3978/j.issn.2305-5839.2015.08.11.

546 [35] Medeiros F, Lindor NM, Couch FJ, Highsmith WE Jr. The germline MLH1 K618A variant and susceptibility to
547 Lynch syndrome-associated tumors. *J MolDiagn*. 2012 May-Jun; 14(3):264-73. doi:10.1016/j.jmoldx.2012.01.006.

548 [36] Shain AH, Yeh I, Kovalyshyn I, Sriharan A, Talevich E, Gagnon A, Dummer R, North J, Pincus L, Ruben B,
549 Rickaby W, D'Arrigo C, Robson A, Bastian BC. 2015. The Genetic Evolution of Melanoma from Precursor Lesions. *N*
550 *Engl J Med* 373(20):1926-36. doi: 10.1056/NEJMoa1502583.

551 [37] Hodgson JT, Darnton A. 2000. The Quantitative Risks of Mesothelioma and Lung Cancer in Relation to Asbestos
552 Exposure. *AnnOccupHyg* 44:565–601. doi: 10.1136/oem.2009.052860.

553 [38] Ascoli V, Cavone D, Merler E, Barbieri PG, Romeo L, Nardi F, Musti M. 2007. Mesothelioma in blood related
554 subjects: report of 11 clusters among 1954 Italy cases and review of the literature. *Am J IndMed* 50(5):357-69.

555 [39] Ascoli V, Romeo E, Carnovale Scalzo C, Cozzi I, Ancona L, Caraviani F, Balestri A, Gasperini L, Forastiere F.
556 2014. Familial malignant mesothelioma: a population-based study in Central Italy (1980-2012). *Cancer Epidemiol*
557 *38:273-278*. doi: 10.1016/j.canep.2014.02.014.

558 [40] Dogan AU, Baris YI, Dogan M, Emri S, Steele I, Elmishad AG, Carbone M. 2006. Genetic predisposition to fiber
559 carcinogenesis causes a mesothelioma epidemic in Turkey. *Cancer Res* 66(10):5063-8.

560 [41] de Klerk N, Alfonso H, Olsen N, Reid A, Sleith J, Palmer L, Berry G, Musk AB. 2013. Familial aggregation of
561 malignant mesothelioma in former workers and residents of Wittenoom, Western Australia. *Int J Cancer* 132(6):1423-8.
562 doi: 10.1002/ijc.27758.

563 [42] Rusch A, Ziltener G, Nackaerts K, Weder W, Stahel RA, Felley-Bosco E. 2015. Prevalence of BRCA-1
564 associated protein 1 germline mutation in sporadic malignant pleural mesothelioma cases. *Lung Cancer* 87(1):77-9.
565 doi:10.1016/j.lungcan.2014.10.017.

566 [43] Sneddon S, Leon JS, Dick IM, Cadby G, Olsen N, Brims F, Allcock RJ, Moses EK, Melton PE, de Klerk N, Musk
567 AW, Robinson BW, Creaney J. Absence of germline mutations in BAP1 in sporadic cases of malignant
568 mesothelioma. *Gene*. 2015 May 25; 563(1):103-5. doi: 10.1016/j.gene.2015.03.031.

569 [44] Jovanovic P, Mihajlovic M, Djordjevic-Jocic J, Vlajkovic S, Cekic S, Stefanovic V. 2013. Ocular melanoma: an
570 overview of the current status. *Int J Clin Exp Pathol* 6(7):1230-44.

571 [45] Read J, Wadt KAW, Hayward NK. 2015. Melanoma genetics. *J Med Genet* 0:1-14. doi: 10.1136/jmedgenet-2015-
572 103150.

573 [46] Arzt L, Quehenberger F, Halbwedl I, Mairinger T, Popper HH. 2014. BAP1 protein is a progression factor in
574 malignant pleural mesothelioma. *Pathol Oncol Res* 20(1):145-51. doi: 10.1007/s12253-013-9677-2.

- 575 [47]Baumann F, Flores E, Napolitano A, Kanodia S, Taioli E, Pass H, Yang H, Carbone M. 2015. Mesothelioma
576 patients with germline BAP1 mutations have 7-fold improved long-term survival. *Carcinogenesis* 36(1):76-81. doi:
577 10.1093/carcin/bgu227.
- 578 [48] Yoshikawa Y, Sato A, Tsujimura T, Emi M, Morinaga T, Fukuoka K, Yamada S, Murakami A, Kondo N,
579 Matsumoto S, Okumura Y, Tanaka F, Hasegawa S, Nakano T, Hashimoto-Tamaoki T. 2012. Frequent inactivation of
580 the BAP1 gene in epithelioid-type malignant mesothelioma. *Cancer Sci* 103(5):868-74. doi: 10.1111/j.1349-
581 7006.2012.02223.x.
- 582 [49] Pedace L, De Simone P, Castori M, Sperduti I, Silipo V, Eibenschutz L, De Bernardo C, Buccini P, Moscarella E,
583 Panetta C, Ferrari A, Grammatico P, Catricalà C. 2011. Clinical features predicting identification of CDKN2A
584 mutations in Italian patients with familial cutaneous melanoma. *Cancer Epidemiol* 35(6):e116-20.
- 585 [50] Ghiorzo P, Villaggio B, Sementa AR, Hansson J, Platz A, Nicolás G, Spina B, Canepa M, Palmer JM, Hayward
586 NK, Bianchi-Scarrà G. 2004. Expression and localization of mutant p16 proteins in melanocytic lesions from familial
587 melanoma patients. *Hum Pathol* 35(1):25-33.
- 588 [51] Lo Iacono M, Monica V, Righi L, Grosso F, Libener R, Vatrano S, Bironzo P, Novello S, Musmeci L, Volante
589 M, Papotti M, Scagliotti GV. 2015. Targeted next-generation sequencing of cancer genes in advanced stage malignant
590 pleural mesothelioma: a retrospective study. *J Thorac Oncol* 10(3):492-9. doi: 10.1097/JTO.0000000000000436.
- 591 [52] Kollipara R, Cooley LD, Horii KA, Hetherington ML, LeBoit PE, Singh V, Zwick DL. 2014. Spitzoid Melanoma
592 in a Child with Li-Fraumeni Syndrome *Pediatr Dev Pathol* 17(1):64-69. doi: 10.2350/13-09-1380-CR.1.
- 593 [53] Curiel-Lewandrowski C, Speetzen LS, Cranmer L, Warneke JA, Loescher LJ. 2011. Multiple primary cutaneous
594 melanomas in Li-Fraumeni syndrome. *Arch Dermatol* 147(2):248-50. doi: 10.1001/archdermatol.2010.428.
- 595 [54] Ceelen WP, Van Dalen T, Van Bockstal M, Libbrecht L, Sijmons RH. 2011. Malignant peritoneal mesothelioma in
596 a patient with Li-Fraumeni syndrome. *J Clin Oncol*. 29(17):e503-5. doi: 10.1200/JCO.2010.34.1933.
- 597 [55] Bacin F, Kemeny JL, D'Hermies F, Rozan R, Decroix P, Dalens H, Kalifa C. 1993. Malignant melanoma of the
598 choroid associated with neurofibromatosis. *J Fr Ophtalmol* 16(3):184-90.
- 599 [56] Baser ME, Rai H, Wallace AJ, Evans DG. 2005. Neurofibromatosis 2 (NF2) and malignant mesothelioma in a man
600 with a constitutional NF2 missense mutation. *Fam Cancer*. 4(4):321-2.
- 601 [57] Shields JA, Shields CL, Lavrich J. 2002. Melanocytoma of optic disk in a patient with neurofibromatosis 2 *Retina*
602 22(2):222-3.
- 603 [58] Zauderer MG, Bott M, McMillan R, Sima CS, Rusch V, Krug LM, Ladanyi M. 2013. Clinical Characteristics of
604 Patients with Malignant Pleural Mesothelioma Harboring Somatic BAP1 Mutations. *J Thorac Oncol* 8(11):1430-3. doi:
605 10.1097/JTO.0b013e31829e7ef9.
- 606 [59] Sekido Y. 2013. Molecular pathogenesis of malignant mesothelioma. *Carcinogenesis* 34(7):1413-9. doi:
607 10.1093/carcin/bgt166.
- 608 [60] AIRTUM Working Group. 2013. Italian cancer figures, report 2013: Multiple tumours. *Epidemiol Prev* 37(4-5
609 Suppl 1):1-152.
- 610 [61] Xu J, Kadariya Y, Cheung M, Pei J, Talarchek J, Sementino E, Tan Y, Menges CW, Cai KQ, Litwin S, Peng H,
611 Karar J, Rauscher FJ, Testa JR. 2014. Germline mutation of Bap1 accelerates development of asbestos-induced
612 malignant mesothelioma. *Cancer Res* 74(16):4388-97. doi: 10.1158/0008-5472.CAN-14-1328.

613

614 URL

- 615 <http://www.ncbi.nlm.nih.gov/SNP/>
616 <http://www.1000genomes.org/1000-genomes-browsers>
617 [http:// evs.gs.washington.edu/EVS/](http://evs.gs.washington.edu/EVS/)
618 <http://exac.broadinstitute.org>
619 <http://www.ncbi.nlm.nih.gov/>
620 <http://www.ensembl.org>
621 <http://www.mutationtaster.org>
622 http://sift.jcvi.org/www/SIFT_enst_submit.html
623 http://provean.jcvi.org/seq_submit.php
624 <http://genetics.bwh.harvard.edu/pph2/>
625 <http://mutationassessor.org/v1>
626 <http://bg.upf.edu/fannsdb/>
627 <http://www.sbg.bio.ic.ac.uk/phyre2/html/page.cgi?id=index>
628 <http://www.umd.be/HSF3/>
629 http://genes.mit.edu/burgelab/maxent/Xmaxentscan_scoreseq_acc.html
630 http://www.fruitfly.org/seq_tools/splice.html
631 <http://www.cbs.dtu.dk/services/NetGene2/>

632 <http://genes.mit.edu/GENSCAN.html>
633 <http://www.softberry.com/berry.phtml?topic=fgenes&group=help&subgroup=gfind>
634 <http://www.softberry.com/berry.phtml?topic=fsplce&group=help&subgroup=gfind>
635
636
637
638
639
640

641 **Figure 1 - Families with germline mutations**

642

643 The probands for each family are denoted by a black arrow. A plus symbol indicates individuals
644 who carry germline mutations, a minus symbol indicates wild type individuals. A grey arrow
645 denotes the mutation in the electropherograms. PB (peripheral blood), CM (cutaneous melanoma),
646 MM (mesothelioma), FFPE (formalin-fixed paraffin-embedded).

647
648 A. Family ID5. A1. Pedigree: the proband (II-4) had multiple cancers, her brother (II-1) had basal
649 cell carcinoma of the skin and her mother (I-2) had gastric cancer. A2. Electropherograms: *BAP1*
650 germline mutation (c.1153C>T p.Arg385*) was carried in PB and in both tumors of the proband (II-
651 4 PB, II-4 CM, II-4 MM). The proband's healthy daughter (III-2 PB) also carries the mutation.
652 Other family members were not available. A3. IHC: II-4 CM: cutaneous melanoma cells showed
653 the expression of specific Melanoma Antigen (Melan A); the same cells showed the loss of BAP1
654 nuclear expression (thin arrow), while BAP1 nuclear staining was retained in normal cells of the
655 surrounding skin (thick arrow) and infiltrating inflammatory cells II-4 MM: epithelioid
656 mesothelioma cells showed the expression of specific mesothelial antigen (Calretinin); the same
657 cells showed the loss of BAP1 nuclear expression (thin arrows), while BAP1 nuclear staining was
658 retained in the normal endothelial cells and infiltrating inflammatory cells (thick arrows).

659
660 B. Family ID16. B1. Pedigree: the proband (IV-1) had two cutaneous amelanotic melanomas, her
661 mother (III-5) had non-Hodgkin cutaneous lymphoma and her paternal uncle (III-2) had cutaneous
662 melanoma. B2. Electropherograms: a *BAP1* missense mutation (c.1700A>C p.Asp567Ala) was
663 found in the proband (IV-1 PB), in a sister (IV-2 PB), in her mother (III-5 PB) and in her maternal
664 aunt (III-6 PB). The mutation was heterozygous also in both cutaneous amelanotic melanomas of
665 the proband (IV-1 CM₁, IV-1 CM₂). B3. Microsatellite marker (D3S3026): a decreased amount
666 of paternal allele was shown in a specimen from the second melanoma developed by the proband
667 (IV-1 T, grey arrow) as compared with genomic DNA. B4. IHC: BAP1 was normally expressed in
668 the nucleus of both cutaneous amelanotic melanomas of the proband (IV-1 CM₁ and IV-1 CM₂).

669
670 C. Family ID3. C1. Pedigree: the proband (III-3) had cutaneous melanoma, the proband's mother
671 (II-3) had cutaneous melanoma and mesothelioma. C2. Electropherograms: *CDKN2A* germline
672 mutation (c.301G>T p.Gly101Trp) was detected in the proband (III-3 PB) and in the proband's
673 mother (II-3 FFPE non-tumor tissue, II-3 MM). Melanoma specimen of II-3 was not available. C3.
674 IHC: epithelioid mesothelioma from the proband's mother (II-3 MM) showed intranuclear
675 positivity to anti p16 antibody in neoplastic cells (left panel). The intensity of nuclear expression
676 was slightly lower in less differentiated tumor cells (right panel).

677
678
679
680
681

682 **Figure 1**
683

A Family ID5

A1

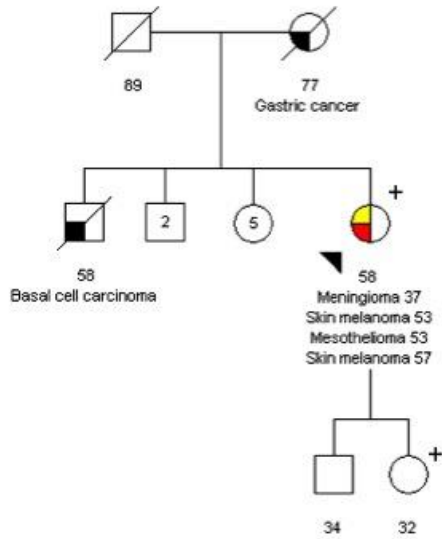

A2

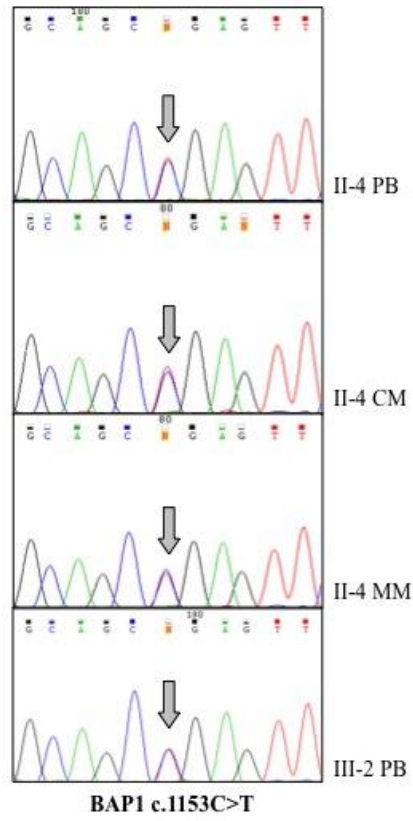

A3

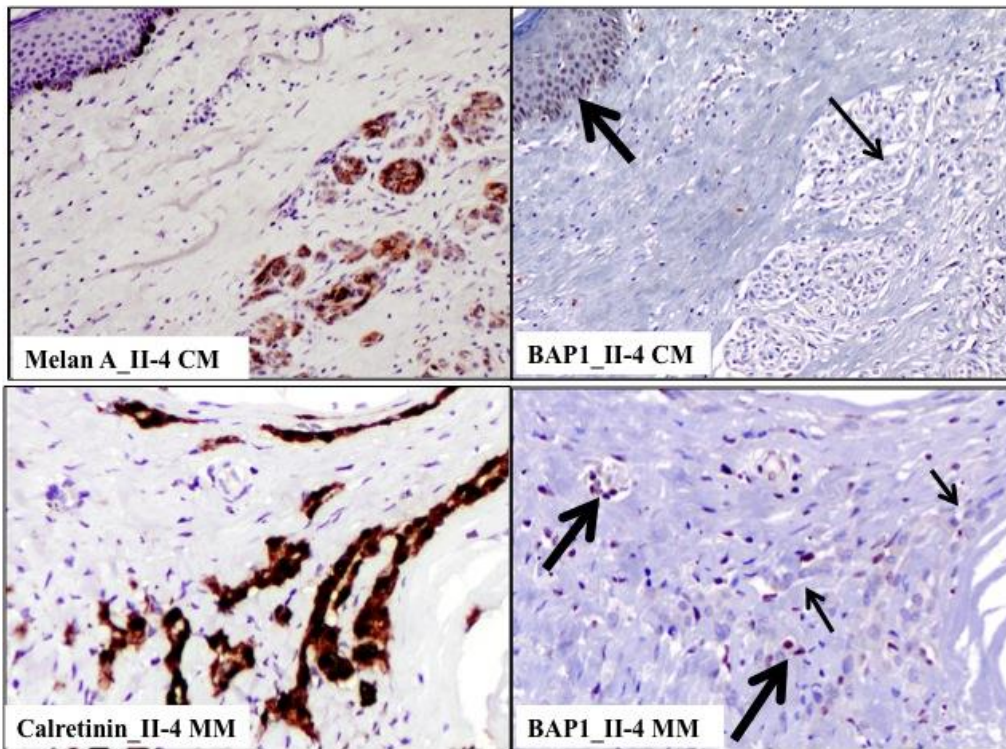

684
19

B Family ID16

B1

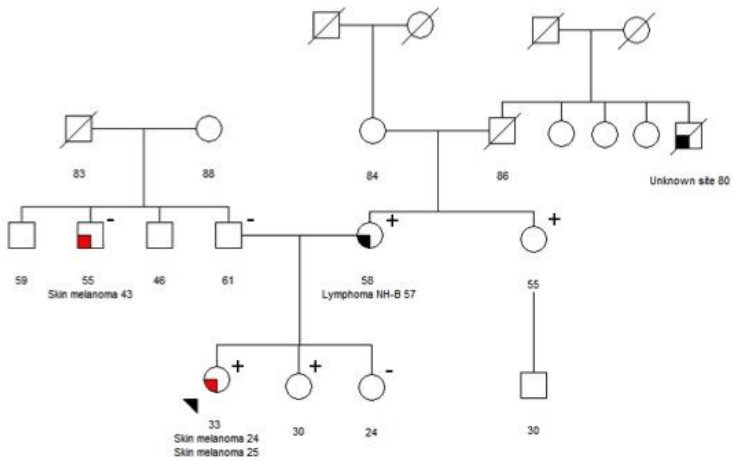

B2

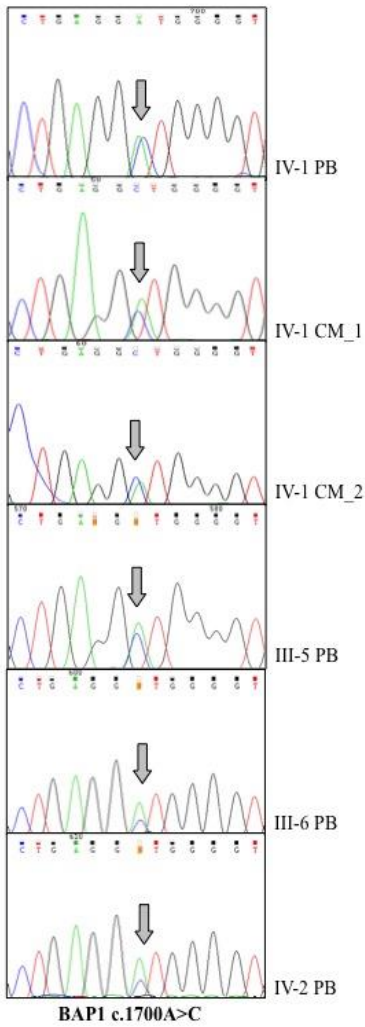

B3

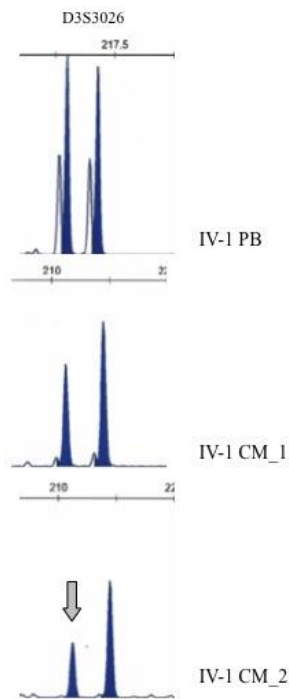

B4

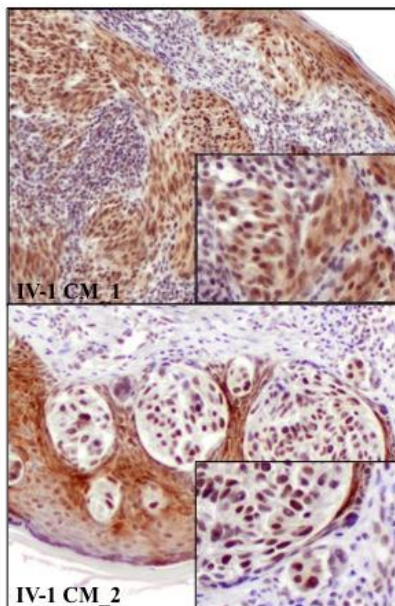

C Family ID3

C1

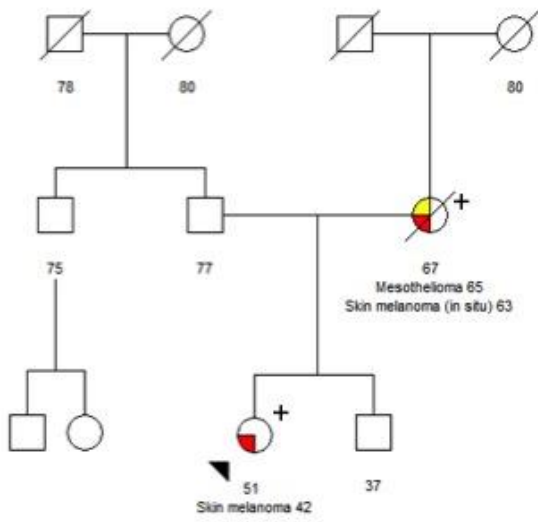

C2

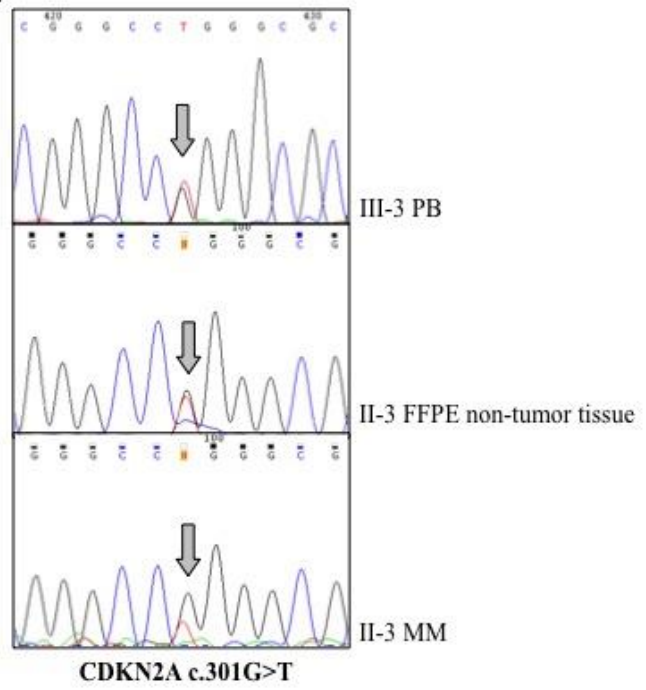

C3

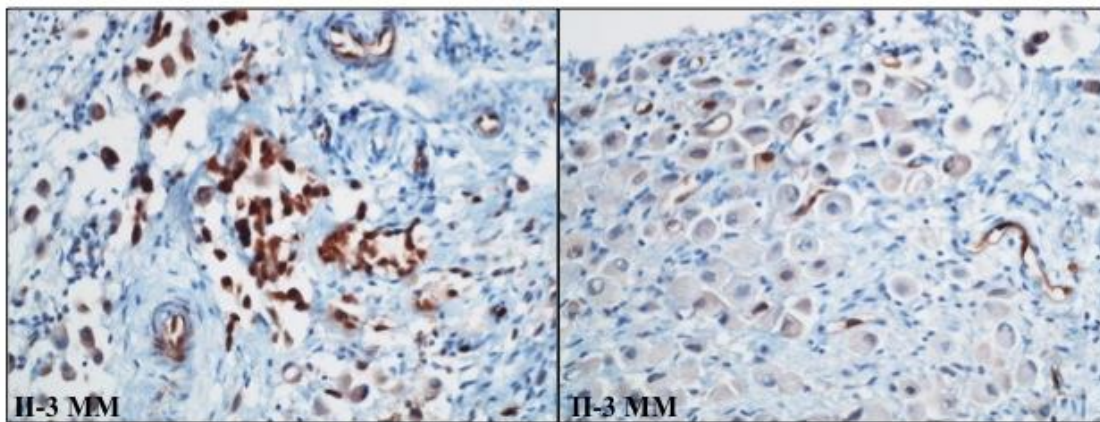

690 **Table I** – Concise clinical details and testing results of the 40 probands
 691

Family ID (sex)	Proband's tumors (age at diagnosis)	Family history	BAP1	CDKN2A	CDK4 (ex2)	TERT (prom)	MITF (p.Glu318Lys)	POT1 (ex10)	Other genes
Probands/families with both mesothelioma and melanoma									
1 (F)	Cutaneous melanoma (33)	Biphasic mesothelioma (mother) Breast cancer (maternal grandmother)	wt	wt	wt	wt	wt	wt	
2 (F)	Nasopharynx carcinoma (24) Cutaneous melanoma (43) Rectal carcinoma (56)	Mesothelioma (father) other tumors in relatives of the paternal family	wt	wt	wt	wt	wt	wt	TP53 wt
3 (F)	Cutaneous melanoma (42)	Mesothelioma and cutaneous melanoma (mother)	wt	c.301G>T p.Gly101Trp	wt	nd	wt	nd	-
4 (F)	Cutaneous melanoma (30) Breastcancer (58)	Mesothelioma (father), breast cancer (mother), papillary renal cell carcinoma type 2 (brother)	c.-247dupCCTTCGC CCCCGTCCCTCC	wt	wt	wt	wt	nd	-
5 (F)	Meningioma (37) Cutaneous melanoma (53) Epithelioid pleura lmesothelioma (53) Cutaneous melanoma (57)	Gastric cancer (mother), basal cell carcinoma of the skin (brother)	c.1153C>T p.Arg385*	wt	wt	wt	wt	wt	-
6 (M)	Epithelioid mesothelioma (65)	Melanoma (brother)	wt	wt	wt	wt	wt	nd	-
Probands/families with melanoma (without mesothelioma) and features of inherited cancer predisposition									
7 (F)	Bilateral uveal melanoma (25, 30) Breast cancer (<i>in situ</i> , 40)	Acoustic neurinoma (sister), bladder (mother), head/neck tumors in both maternal and paternal families	wt	wt	wt	wt	wt	wt	BRCA1 BRCA2 wt
8 (M)	Iris-Uveal melanoma (31)	Negative	wt	wt	wt	wt	wt	wt	-
9 (F)	Uveal melanoma (67) Cutaneous melanoma (72)	Cutaneous melanoma (daughter, niece)	wt	wt	wt	wt	wt	nd	-
10 (F)	Choroidal melanoma (63) Bilateral breast cancer (60, 65)	Breast cancer (sister, maternal cousin, paternal aunt), renal cancer (maternal aunt)	wt	wt	wt	wt	wt	wt	TP53 BRCA1 BRCA2 wt
11 (F)	Cutaneous melanoma (46)	Ocular melanoma (uveal, father),	wt	wt	wt	wt	wt	wt	-

		colon cancer							
12 (F)	Renal cell cancer (41) Two synchronous cutaneous melanomas (43)	Negative	wt	wt	wt	wt	wt	wt	-
13 (M)	Lentigo maligna melanoma (65)	Cutaneous melanoma, renal cell cancer	wt	wt	wt	wt	wt	wt	-
14 (M)	Lentigo melanoma (54) Two synchronous cutaneous primary melanomas (58)	Cutaneous melanoma (mother), renal cell cancer + uterus cancer + breast cancer (sister), pancreatic carcinoma, liver cancer, prostate cancer	wt	wt	wt	wt	wt	wt	-
15 (F)	Two cutaneous primary melanomas (34, 40)	Cutaneous melanoma (paternal uncles), renal cell cancer (father), lung cancer (two paternal uncles)	wt	wt	wt	wt	wt	wt	-
16 (F)	Two cutaneous amelanotic melanomas (24, 25)	Cutaneous melanoma (paternal uncle), non-Hodgkin cutaneous lymphoma (low grade, CD20+, mother)	c.1700A>C (p.Asp567Ala) c.-594dupCCCGT	wt	wt	wt	wt	wt	-
17 (F)	Two cutaneous primary melanomas (31, 33)	Cutaneous melanoma (father)	wt	wt	wt	wt	wt	wt	-
18 (F)	Two cutaneous melanomas (56, 57)	Cutaneous melanoma (father)	wt	wt	wt	wt	wt	wt	-
19 (F)	Two synchronous cutaneous primary melanomas (67) Facial basal cell carcinoma (69)	Cutaneous melanoma (brother), breast cancer, CNS, prostate cancer	wt	wt	wt	wt	wt	wt	-
20 (M)	Cutaneous melanoma (20)	Cutaneous melanoma (mother), breast and colon cancer	wt	wt	wt	wt	wt	wt	-
21 (M)	Cutaneous melanoma (24)	Cutaneous melanoma (mother), prostate cancer, vulvar cancer	wt	wt	wt	wt	wt	wt	-
22 (F)	Cutaneous melanoma (<i>in situ</i> , 27)	Cutaneous melanoma (father), prostate cancer	wt	wt	wt	wt	wt	wt	-
23 (M)	Cutaneous melanoma (32)	Cutaneous melanoma (sister)	wt	wt	wt	wt	wt	wt	-
24 (F)	Cutaneous melanoma (35)	Cutaneous melanoma + thyroid cancer (father)	wt	wt	wt	wt	wt	wt	-
25 (F)	Cutaneous melanoma (39)	Cutaneous melanoma + colon cancer (brother)	wt	wt	wt	wt	wt	wt	-

26 (M)	Cutaneous melanoma (82)	Cutaneous melanoma (brother), pancreatic cancer (sister)	wt	wt	wt	wt	nd	nd	-
27 (M)	Testicular teratoma (27) Multinodular goiter Ten cutaneous primary melanomas (38 to 52)	Breast cancer (mother)	wt	p.Thr77Ala [§]	wt	wt	wt	wt	-
28 (M)	Lipoma (27) Adrenal cortex adenoma (53) Three cutaneous primary melanomas (57, 58)	Prostate cancer (father), liver cancer (paternal uncle and paternal grandfather)	wt	wt	wt	wt	wt	wt	-
29 (M)	Cutaneous melanoma (61)	Breast cancer (sister and two paternal aunts), lung cancer (paternal uncle)	wt	wt	wt	wt	wt	nd	-
Probands/families with mesothelioma (without melanoma) and features of inherited cancer predisposition									
30 (F)	Epithelioid pleural mesothelioma (46)	Mesothelioma (mother)	wt	wt	wt	wt	wt	nd	-
31 (M)	Biphasic peritoneal mesothelioma(49)	Mesothelioma (three sisters and brother)	nd ^{^,*}	wt	wt	nd*	nd*	nd*	-
32 (M)	Biphasic pleural mesothelioma (53)	Mesothelioma (paternal uncle and two cousins), leukemia (twin brother of the father)	wt	wt	wt	wt	wt	nd	-
33 (M)	Epithelioid pleural mesothelioma (55)	Mesothelioma (paternal grandmother), prostate cancer (father)	wt	wt	wt	wt	wt	nd	-
34 (M)	Epithelioid pleural mesothelioma (68)	Mesothelioma (sister and nephew)	wt	wt	wt	wt	wt	nd	-
35 (M)	Epithelioid pleural mesothelioma (70)	Mesothelioma (both parents), papillary thyroid carcinoma (daughter)	wt	wt	wt	wt	wt	nd	-
36 (M)	Sarcomatoid mesothelioma (66)	Mesothelioma (father and cousin)	wt	wt	wt	wt	wt	nd	-
37 (M)	Mesothelioma Neuroblastoma	Negative	nd ^{^,*}	nd*	nd*	nd*	nd*	nd*	-
38 (F)	Epithelioid mesothelioma (28) Hodgkin linfoma (18)	Negative	wt	wt	wt	wt	wt	nd	-
39 (M)	Epithelioid mesothelioma Basalioma	Negative	nd ^{^,*}	nd*	nd*	nd*	nd*	nd*	-
40 (F)	Epithelioid mesothelioma (69)	Lung cancer (uncertain diagnosis,	wt	nd	nd	nd	nd	nd	-

		mother)							
--	--	---------	--	--	--	--	--	--	--

692 wt (wild type), nd (not done)

693 ^IHC: normal nuclear expression; *Germline DNA not available or very scanty

694

695 § This patient was reported by Pastorino et al. (2008) [1]. The authors considered this variant as possibly damaging, using a single prediction tool (Polyphen). We have integrated
696 this *in silico* analysis using six prediction tools, i.e. Mut taster, SIFT, Provean, Mut assessor, Condel, and Phyre2. To assess a possible aberrant splicing we used Human Splicing
697 Finder, MaxEnt, BDGP, NetGene2, GeneScan, FGENESH 2.6 and FSPLICE 1.0. Four out of seven disease-causing prediction tools reported the p.Thr77Ala variant as neutral.
698 No data are reported for LOH, IHC and segregation analysis. Moreover, none of the 7 splice-site prediction tools has shown the creation of alternative splice sites for this variant.
699 Thus, we concluded that the p.Thr77Ala variant should be considered as a VUS and the patient was considered eligible for mutation analysis in other genes.

700

701 [1] Pastorino L, Bonelli L, Ghiorno P, Queirolo P, Battistuzzi L, Balleari E, Nasti S, Gargiulo S, Gliori S, Savoia P, Abate Osella S, Bernengo MG, Bianchi Scarrà G. 2008.
702 CDKN2A mutations and MC1R variants in Italian patients with single or multiple primary melanoma. *Pigment CellMelanomaRes* 21(6):700-9. doi: 10.1111/j.1755-
703 148X.2008.00512.x.

704

705

706

Supplementary Figure 1- *BAP1* germline duplications

The proband is denoted by a black arrow. A plus symbol indicates individuals with germline variant. A grey arrow denotes the mutation in the electropherogram. PB (peripheral blood).

A. Family ID16. Pedigree is reported in Figure 1B. A1. Electropherogram: a new germline 5bp duplication (c.-594dupCCCGT) in the *BAP1* promoter region was found in the proband (IV-1 PB), in a sister (IV-2 PB), in her mother (III-5 PB) and in her maternal aunt (III-6 PB). This duplication is *in cis* with the p.Asp567Ala missense variant.

B. Family ID4. B1. Pedigree: the proband (II-1) had cutaneous melanoma and breast cancer, the brother (II-2) had papillary renal cell carcinoma type 2, the father (I-1) died for mesothelioma and the mother (I-2) had breast cancer. B2. Electropherogram: a new germline 19bp duplication (c.-247dupCCTTCGCCCCCGTCCCTCC) in the *BAP1* promoter region was found in the proband (II-1 PB). No specimens from relatives were available for segregation analysis.

Supplementary Figure 1

A Family ID16

A1

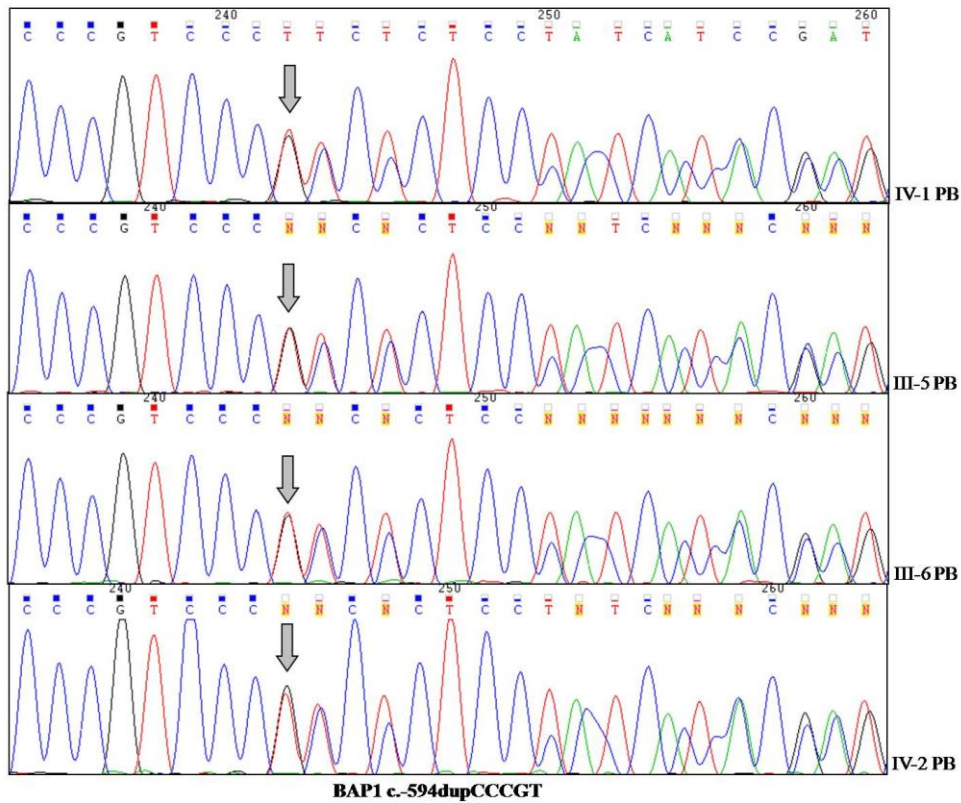

B Family ID4

B1

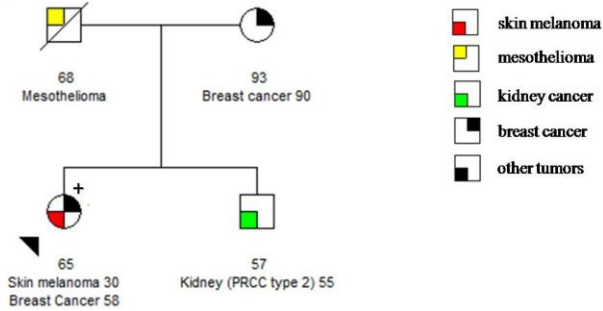

B2

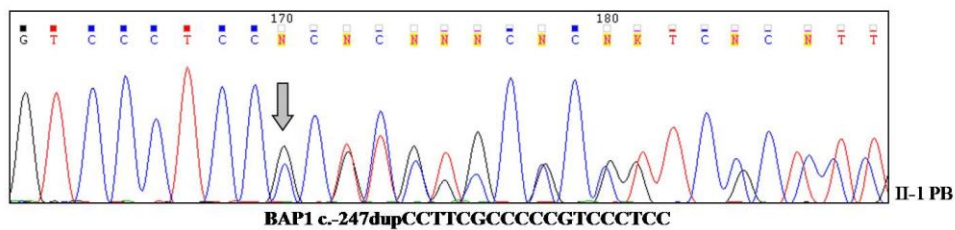

Supplementary Figure 2 - Predicted structure of BAP1 protein

Predicted structure of BAP1 protein according to Protein Homology/analogy Recognition Engine v 2.0 (Phyre2). The yellow arrows indicate the position of D567 (a) or the mutant A567 (b).

The wild type negative charged D567 seems to localize at the interface with the ubiquitin carboxy-terminal hydrolase domain (residues 1-240) depicted in dark to light blue with the catalytic sites Q85, C91, H169 and D184 shown in white. Known domains are indicated with different colours according to their position: HCFC1 binding motif in green (residues 363-366), the long alpha helix of the BRCA1 binding domain in orange (residues 629-659/669) and the Nuclear Localization Signal (NLS, residues 717-722) in red.

The mutant hydrophobic A567 is predicted buried within the globular portion of the protein and the relevant domains of the BAP1 protein seem to assume a different position.

Supplementary Figure 2

a)

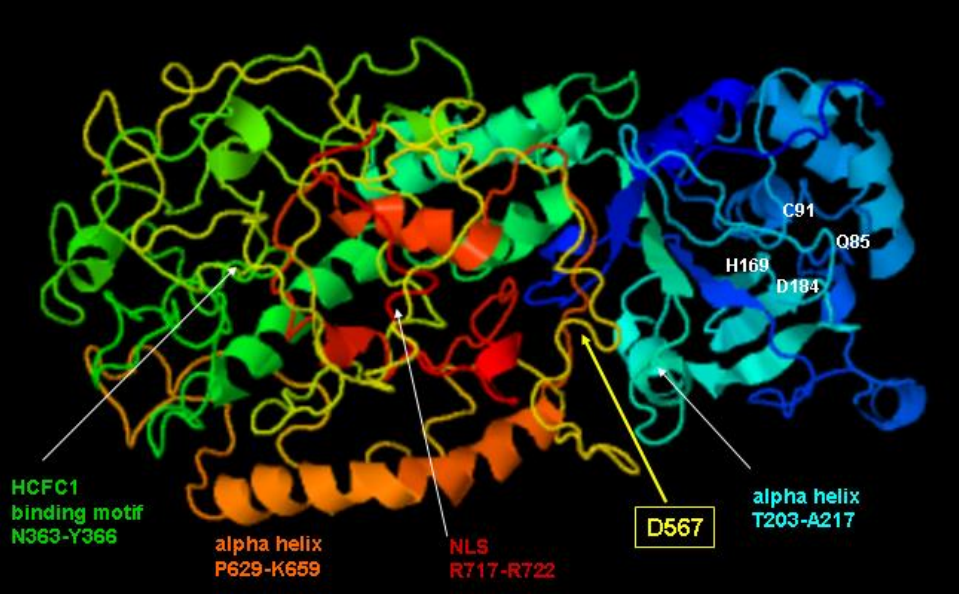

b)

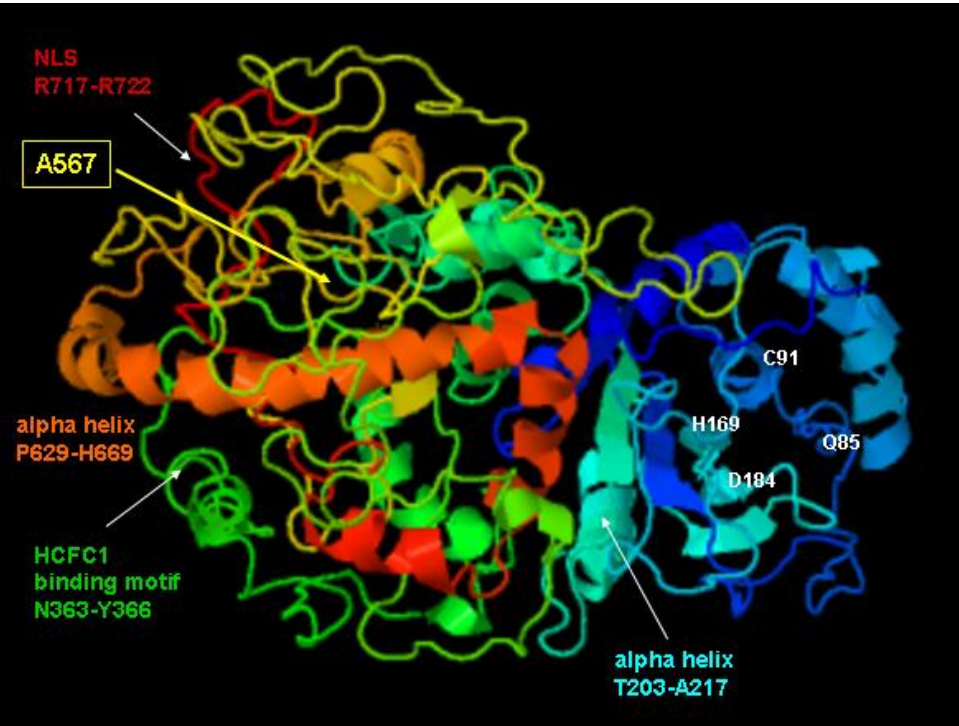

Supplementary Table I – Probands clinical data

Family ID (sex)	Age at diagnosis	Proband's tumors	Other clinical information	Asbestos exposure	Follow-up (years)	Family history
Cases/families with the association of cutaneous melanoma and mesothelioma						
1 (F)	33	Cutaneous melanoma of the left leg (superficial spreading melanoma, 0.46 mm Breslow thickness, Stage IA)	No dysplastic nevi, 10-50 melanocytic nevi, Fitzpatrick skin phototype II	Not registered (mother)	No relapse (5)	Mesothelioma (mother), breast cancer (maternal grandmother)
2 (F)	43	Cutaneous melanoma of the abdomen (superficial spreading melanoma, 0.20 mm Breslow thickness, Stage pT1)	High grade naso pharynx carcinoma with lymph node metastasis (24) Rectal carcinoma (56)	Not registered (father)	Exitus for metastatic rectal carcinoma (14)	Mesothelioma (father) and other tumors in the paternal family
3 (F)	41	Cutaneous melanoma (superficial spreading melanoma, 1.00 mm Breslow thickness Stage IB)	Previous excision of several dysplastic nevi Fitzpatrick skin phototype II	Possible occupational exposure as cotton weaver for 5 years (mother)	No relapse (10)	Mesothelioma and cutaneous melanoma (mother)
4 (F)	30	Cutaneous melanoma of the left leg (superficial spreading melanoma, Breslow thickness not available)	Breast cancer (58)	Not registered (father)	Subcutaneous metastasis (35)	Mesothelioma (father), breast cancer (mother), papillary renal cell carcinoma type 2 (brother)
5 (F)	53	Cutaneous melanoma of the ear (53) (superficial spreading melanoma, 1.1 cm Breslow thickness Stage pT2a), epithelioid pleural mesothelioma (53), cutaneous melanoma of the scalp (57)	Meningioma (37)	No exposure to asbestos could be identified, but residential history was incomplete	No relapse (5)	Gastric cancer (mother), basal cell carcinoma of the skin (brother)
6 (M)	65	Epithelioid mesothelioma	-	No interview available	(3)	Melanoma (brother), colon cancer (father)
Cases/families with melanoma (without mesothelioma) and with familiarity for <i>BAP1</i> associated tumors (i.e. early onset melanoma, either ocular or cutaneous, multiple primary tumors, positive family history, development of other tumors except mesothelioma)						

Family ID (sex)	Age at diagnosis	Proband's tumors	Other clinical information	Asbestos exposure	Follow-up (years)	Family history
7 (F)	25 and 30	Bilateral ocular melanoma (uvea)	<i>In situ</i> ductal breast tumor (40)	-	No relapse (23)	Acoustic neurinoma (sister), larynx tumor (father and two paternal relatives), bladder tumor (mother)
8 (M)	31 and 33	Ocular melanoma (iris-uvea)	No dysplastic nevi <10 melanocytic nevi Fitzpatrick skin phototype III	-	No relapse (5)	Negative
9 (F)	67 and 72	Ocular melanoma (uvea) and cutaneous melanoma (1 st Clark level)	Thyroidectomy for goiter (58) Schwannoma of the auditory nerve - facial dx (71)	-	No relapse (1)	Cutaneous melanoma (daughter and niece), lung cancer (father)
10 (F)	63	Ocular melanoma (choroid)	Bilateral breast cancer (60, 65)	-	No relapse (7)	Breast cancer (sister, maternal cousin, paternal aunt), renal cancer (maternal aunt)
11 (F)	46	Cutaneous melanoma of the abdomen (superficial spreading melanoma, 0.20 mm Breslow thickness, Stage IA)	No dysplastic nevi, <10 melanocytic nevi	-	No relapse (4)	Ocular melanoma (uveal, father), colon cancer
12 (F)	43	Two synchronous cutaneous melanomas of left and right leg (superficial spreading melanoma, 0.20 and 0.28mm Breslow thickness, Stage IA)	No dysplastic nevi, <10 melanocytic nevi, Fitzpatrick skin phototype III Renal cell cancer, clear cells with focal areas of papillary architecture (41)	-	No relapse (4)	Negative
13 (M)	65	Lentigo maligna melanoma of the right forearm (0.23mm Breslow thickness, Stage IA)	No dysplastic nevi Fitzpatrick skin phototype II	-	No relapse (13)	Cutaneous melanoma (daughter, nephew), renal cell carcinoma (brother)
14 (M)	54 and 58	Three cutaneous primary melanomas: lentigo melanoma of the left cheekbone (Stage 0); two synchronous cutaneous melanomas of the left shoulder and lumbar region (superficial spreading melanoma 0.65 mm Breslow thickness, Stage IA and 2.34 mm Breslow thickness, Stage IIIB)	No dysplastic nevi, >50 melanocytic nevi, Fitzpatrick skin phototype I	-	Exitus for metastatic melanoma (5)	Cutaneous melanoma (mother), renal cell carcinoma + uterus cancer + breast cancer (sister), pancreatic carcinoma, liver, prostate

Family ID (sex)	Age at diagnosis	Proband's tumors	Other clinical information	Asbestos exposure	Follow-up (years)	Family history
15 (F)	34 and 40	Two cutaneous primary melanomas of the supraclavicular left and left breast regions (superficial spreading melanomas, 0.64 and 0.23 mm Breslow thickness, Stage IA)	No dysplastic nevi, > 50 nevi melanocytic nevi, Fitzpatrick skin phototype III	-	No relapse (10)	Cutaneous melanoma (paternal uncles), renal cell cancer (father), lung cancer (two paternal uncles)
16 (F)	24 and 25	Two cutaneous amelanotic melanomas of the left shoulder and of the right arm (nodular melanoma, 1.80 mm Breslow thickness, Stage IB and superficial spreading melanoma, 0.30 mm Breslow thickness, Stage IA)	No dysplastic nevi, >50 clinical atypical melanocytic nevi Fitzpatrick skin phototype II	-	No relapse (9)	Cutaneous melanoma (paternal uncle), non-Hodgkin cutaneous lymphoma (low grade, CD20+, mother)
17 (F)	31 and 33	Two cutaneous primary melanomas (superficial spreading melanoma, Breslow thickness not available)	-	-	Not available	Cutaneous melanoma (father)
18 (F)	56 and 57	Two cutaneous melanomas (superficial spreading melanoma, Breslow thickness not available)	-	-	Not available	Cutaneous melanoma (father)
19 (F)	67	Two synchronous cutaneous melanomas of the right hip and of the right arm (superficial spreading melanoma, 0.20 mm Breslow thickness, Stage IA and melanoma <i>in situ</i> , Stage 0)	No dysplastic nevi, <10 melanocytic nevi Fitzpatrick skin phototype II Facial basal cell carcinoma (69)	-	No relapse (4)	Cutaneous melanoma (sister), breast cancer, CNS, prostate cancer
20 (M)	20	Cutaneous melanoma of left leg (superficial spreading melanoma, 0.52 mm Breslow thickness, Stage IA)	No dysplastic nevi, <10 melanocytic nevi Fitzpatrick skin phototype II	-	No relapse (3)	Cutaneous melanoma (mother), breast and colon cancer
21 (M)	24	Cutaneous melanoma of the abdomen (superficial spreading melanoma, 0.26 mm Breslow thickness, Stage IA)	No dysplastic nevi, <10 melanocytic nevi, Fitzpatrick skin phototype II	-	No relapse (6)	Cutaneous melanoma (mother), prostate cancer, vulvar cancer
22 (F)	27	Cutaneous <i>in situ</i> melanoma on the back (Stage 0)	Dysplastic nevi, >50 melanocytic nevi, Fitzpatrick skin phototype II	-	No relapse (5)	Cutaneous melanoma (father), prostate cancer
23 (M)	32	Cutaneous melanoma of the sternum (nodular melanoma, 2.10 mm Breslow thickness, Stage IIB)	No dysplastic nevi, <10 melanocytic nevi, Fitzpatrick skin phototype II	-	No relapse (3)	Cutaneous melanoma (sister)

Family ID (sex)	Age at diagnosis	Proband's tumors	Other clinical information	Asbestos exposure	Follow-up (years)	Family history
24 (F)	35	Cutaneous melanoma of the right scapula (superficial spreading melanoma, 0.90 mm Breslow thickness, Stage IB)	No dysplastic nevi, 10-50 melanocytic nevi, Fitzpatrick skin phototype II	-	No relapse (3)	Cutaneous melanoma + thyroid cancer (father)
25 (F)	39	Cutaneous melanoma (superficial spreading melanoma, Breslow thickness not available)	-	-	Not available	Cutaneous melanoma + colon cancer (brother)
26 M	82	Cutaneous melanoma of the back, (0.83 mm Breslow thickness, 3 rd Clark level)	Fitzpatrick skin phototype III, chronic sun exposure	-	No relapse (1)	Cutaneous melanoma (brother), pancreatic cancer (sister)
27 (M)	38 to 52	Ten cutaneous primary melanomas	Testicular teratoma (27) multinodular goiter	-	Not available	Breast cancer (mother)
28 (M)	57 and 58	Three cutaneous primary melanomas	Lipoma (27) Adrenal cortex adenoma (53)	-	Not available	Prostate cancer (father), liver cancer (paternal uncle and paternal grandfather)
29 (M)	61	Cutaneous melanoma of the back (4.6mm Breslow thickness, 5 th Clark level)	Fitzpatrick skin phototype III, sun exposure	-	No relapse (2)	Breast cancer (sister and two paternal aunts), lung cancer (paternal uncle)
Cases/families with mesothelioma (without melanoma) and with familiarity for <i>BAP1</i> associated tumors (other mesothelioma cases among relatives, development of other tumors except melanoma)						
30 (F)	46	Epithelioid pleural mesothelioma	-	Household (low)	No relapse (10)	Biphasic mesothelioma (mother), lung cancer (father), bone cancer (maternal aunt), bowel cancer (maternal grandmother)
31 (M)	49	Biphasic peritoneal mesothelioma	-	Household	Exitus (7 months)	Mesothelioma (three sisters and brother)
32 (M)	53	Biphasic pleural mesothelioma	-	Household (low)	Exitus (5)	Mesothelioma (paternal uncle and two cousins), leukemia (twin brother of the father)
33 (M)	55	Epithelioid pleural mesothelioma	-	Possible occupational/household (low)	Not available	Mesothelioma (paternal grandmother), prostate cancer (father)
34 M	68	Epithelioid pleural mesothelioma	-	No interview available	No relapse (1)	Mesothelioma (sister and nephew)

Family ID (sex)	Age at diagnosis	Proband's tumors	Other clinical information	Asbestos exposure	Follow-up (years)	Family history
35 (M)	70	Epithelioid pleural mesothelioma	-	Household (low)	No relapse (3)	Mesothelioma (both parents), papillary thyroid carcinoma (daughter)
36 (M)	66	Sarcomatoid mesothelioma	-	Possible occupational exposure as baker 1962-1974 and residential exposure 1947-1977 (in Stradella)	No relapse (2)	Mesothelioma (father and cousin), lung cancer (paternal uncle)
37 (M)	Not available	Mesothelioma, neuroblastoma	-	Possible occupational exposure as pipe-fitter 2003-2004, radiotherapy 1985 (for neuroblastoma)	Not available	Negative
38 (F)	28 and 18	Epithelioid mesothelioma, Hodgkin linfoma	-	Para-occupational exposure 1985-1993 (father boiler and pipe-fitter), radiotherapy 2003 (for NHL)	Exitus (5 months)	Lung cancer (maternal cousin), leukemia (maternal cousin's daughter)

Family ID (sex)	Age at diagnosis	Proband's tumors	Other clinical information	Asbestos exposure	Follow-up (years)	Family history
39 (M)	Not available	Epithelioid mesothelioma, basalioma	-	Possible occupational exposure as house-builder 1944 and 1951-1983	Not available	Negative
40 (F)	69	Epithelioid mesothelioma with metastasis on the scalp	-	Possible occupational exposure as cotton warper 1950-1983 and household exposure 1982 (removal of asbestos-cement roofing)	No relapse (12)	Lung cancer (uncertain diagnosis, mother)

Supplementary Table II – Primer sequences for the amplification of *BAP1*, *CDKN2A*, *CDK4*, *MITF*, *TERT*, *POT1* genes.

GENE	PRIMERS	SEQUENCES	AMPLICON LENGTH (bp)
	BAP1_prom1F BAP1_prom2R	GCTTTAGTCGTTGACACAGG GGGAGAAAAGGCTCTTACCG	1040
BAP1	BAP1_ex1-3F BAP1_ex1-3R	GAAGACGAGCCCAGAGG CGTAGGGTTCTTGGCACTGTC	619
	BAP1_ex4bisF BAP1_ex4bisR	TTCATAAGGAGACTGGGTGGA GACACAGAGAGTGGACTCAG	597
	BAP1_ex5F BAP1_ex5R	TGGGTATTGGTAGGTGCTTG CTTTCCCCGCAACTGCATC	486
	BAP1_ex6-7F BAP1_ex6-7R	TCTGTGTTCTTCCGATTCC GGTCCGGCAATATGGTGTAG	562
	BAP1_ex8F BAP1_ex8R	CGACCAGCTCCTGATTCC CCTGATCTTGCCAGATTACCC	313
	BAP1_ex9F BAP1_ex9R	CAGGTCTGCTGGTTCACCTCC CTATTCTCCCTCCCCACTCC	531
	BAP1_ex10F BAP1_ex10R	GGAAAGGTGGGACTTGGAG AGGGGCCTGTGGTAACAGC	531
	BAP1_ex11F BAP1_ex11R	GGCTGGGCTGTTCTTCTCTG GGAACCACATGGGAAAATTGC	374
	BAP1_ex12F BAP1_ex12R	CAGTGTAAGTGGGTGGCAGC CAAACCTCCGAGGTGCTCAAC	425
	BAP1_ex13F BAP1_ex13R	GGCTTAGCATGGCTAGTTCAAG GCAGGACACTTTGTGGTCAC	715
	BAP1_ex14F BAP1_ex14R	CTTGGAAGTGGCTCACTGGC GAAAGTCTTCTGGCACATGGC	408
	BAP1_ex15-16F BAP1_ex15-16R	GAAGACTTTCTGGGTGGGTGG CCTGCGAAGAGGTAGAGACC	591
	BAP1_ex17F BAP1_ex17R	CCTGAGGCTTGAGCAGACCTTG GCTGTGCCCAACTCCAGATG	466
CDKN2A	p16_ex 1α F p16_ex 1α R	GAAGAAAGAGGAGGGGCTG GCGCTACCTGATTCCAATTC	340
	p14_ex 1β F p14_ex 1β R	CGCTCAGGGAAGGCGGGTG ACCAAACAAAACAAGTGCCG	407
	p16_ex 2F p16_ex 2R	GGGGCTTGTGTGGGGTCTG GTGCTGGAAAATGAATGCTCTG	483
	p16_ex 3F p16_ex 3R	CGGTAGGGACGGCAAGAGAG CCTGTAGGACCTTCGGTGACTGA	179
CDK4	CDK4_ex 2F CDK4_ex 2R	GCTGCAGGTCATACCATCCT ATCATCACACCCACCTATAGG	372
MITF	MITF_ex 9F MITF_ex 9R	TGTGCTCTGCCTATTTCAAGTG AAGAAAACCCCTTCAGGTAAGTT	340
TERT	Prom F Prom R	GTCCTGCCCTTCACCTT AGCACCTCGCGGTAGTGG	488
POT1	POT1_ex10F POT1_ex10R	AGCTGATATTCAACCACACTCGT GCACAAAAGGCTAGGGAAGTATC	435

Supplementary Table III – In silico analyses of BAP1 exonic mutations

BAP1 missense variants (exon) Genomic position on chr3				[Ref] Case ID Tumors in patients with BAP1 variants (Age of diagnosis) and in untested family members								
1000G ExAC	Mut taster	SIFT	Provean	PolyPhen HumVar (HumDiv)	Mutation assessor	Condel	Phyre2	LOH	IHC	Segregation analysis	Splice site prediction	Conclusion
c.41T>A (p.Leu14His) (exon 2) 3:52443756A>T				[23] NCI-1326 RCC (40, 44, 46, 54, 57) in carriers / RCC in other family members								
-	0,9999 diseasecausing	0,000 damaging	-6,04 deleterious	1,00 probablydamaging (1,00)	2,48 medium impact	0,55568 deleterious	likely to affect function (highest score)	clear LOH in proband's tumors	Loss of BAP1 proteinexpression	Variant cosegregates with the RCC predisposition (LOD score 1.2)	No alterations	Disease causing
c.277A>G (p.Thr93Ala) (exon 5) 3:52442072T>C				[22] A Adenocarcinoma of Unknown Primitive Tumor, Breast Ca x3, RCC (37, 39, 40, 47, 47), Cervical Ca, CaSU in carriers / Esophagus Ca x2, Head and Neck Carcinoma, Lung Ca, Breast Ca in other family members								
-	0,9999 diseasecausing	0,001 damaging	-4,56 deleterious	0,989 probablydamaging (0,999)	3,875 higt impact	0,73011 deleterious	likely to affect function (highest score)	RCC sample from the index case shows LOH for the 3pter-14.1 chromosomal region (genomic position 0- 64Mb) as the unique acquired large genomic deletion in this tumor	Loss of BAP1 proteinexpression	Variant segregates with RCC (Segregation analysis based on identity by descend - IBD-)	New cryptic acceptor site (Human Splicing Finder, MaxEnt)	Disease causing

BAP1 missense variants (exon) Genomic position on chr3				[Ref] Case ID Tumors in patients with BAP1 variants (Age of diagnosis) and in untested family members								
1000G ExAC	Mut taster	SIFT	Provean	PolyPhen HumVar (HumDiv)	Mutation assessor	Condel	Phyre2	LOH	IHC	Segregation analysis	Splice site prediction	Conclusion
c.299T>C (p.Leu100Pro) (exon 5) 3:52442050A>G				[11] UM (45, 56), Cholangiocarcinoma (71), Urothelial Carcinoma (48) in carries / RCC, Brain Ca, Leukemia, Uterine Ca in other family members								
-	0,9999 diseasecausing	0,000 damaging	-6,62 deleterious	1,00 probablydamaging (1,00)	3,77 high impact	0,69994 deleterious	likely to affect function (highest score)	LOH of 8 markers, consistent with monosomy 3	nd	Variant segregates with UM (mother-son)	No alterations	Disease causing
c.539T>C (p.Leu180Pro) (exon 7) 3:52441231A>G				[16] FUM124 UM (60), CM (72), MM (71), BCC (56, 65, 68) in carriers / Breast Ca x2, BCC x6, SCC, Non-melanoma Skin Ca, CM x2, Prostate Ca, Uterine Ca, Liposarcoma, Melanoma (meningeal), Cervical Ca, CaSU x3, MM, GI TractCancer in otherfamilymembers								
-	0,9999 diseasecausing	0,000 damaging	-6,90 deleterious	1,00 probablydamaging (1,00)	3,725 high impact	0,70362 deleterious	likely to affect function (highest score)	nd	nd	Variant does not unconditionally track with the disease	No alterations	Disease causing
c.1327A>T (p.Asn443Tyr) (exon 13)3:52437834T>A				[14] 16 UM in carrier / CaSU in otherfamilymembers								
-	0,9997 diseasecausing	0,005 damaging	-0,89 neutral	0,855 possiblydamaging (0,994)	0,55 neutral	0,46382 neutral	unlikely to affect function (highest score)	nd	nd	no data	No alterations	VUS

BAP1 missense variants (exon) Genomic position on chr3				[Ref] Case ID Tumors in patients with BAP1 variants (Age of diagnosis) and in untested family members								
1000G ExAC	Mut taster	SIFT	Provean	PolyPhen HumVar (HumDiv)	Mutation assessor	Condel	Phyre2	LOH	IHC	Segregation analysis	Splice site prediction	Conclusion
c.1445C>T, p.Ser482Leu (exon 13)3:52437716G>A				[14] 19 UM in carrier / CM, Lung Ca x3 in otherfamilymembers								
- 1 het 60.463 All	0,9999 diseasecau sing	0,104 tolerated	-0,71 neutral	0,057 benign (0,760)	0,895 low impact	0,472555 neutral	unlikely to affect function (highest score)	nd	nd	no data	New acceptor site (MaxEnt, NetGene2)	VUS
c.1708C>G p.Leu570Val (exon 13)3:52437453G>C				[21] UM (18, 46, 62), CM (27, 27, 33), MM (47), Peritoneal MM (84), Lung Ca (46), Paraganglioma (42), Breast Ca (75), Malignant Fibrous Histiocytoma (45) in carriers / Prolactinoma in other family member								
-	0,6937 diseasecau sing	0,054 tolerated	-0,52 neutral	0,016 benign (0,075)	0,695 neutral	0,469014 neutral	unlikely to affect function (highest score)	LOH in UM and PGL	nd	Variant segregates in this multi-cancer family	Activation of a cryptic donor site 22bp before the end of the exon (Human Splicing Finder, MaxEnt, BDGP, NetGene2, GeneScan,FGENESH 2.6, FSPLICE 1.0)	Disease causing
c.518A>G (p.Tyr173Cys) (exon 7)3:52441252T>C				[17] UM (72), MM, adenocarcinoma in carriers / MM x2, RCC, ALL in otherfamilymembres								

BAP1 missense variants (exon) Genomic position on chr3				[Ref] Case ID Tumors in patients with BAP1 variants (Age of diagnosis) and in untested family members								
1000G ExAC	Mut taster	SIFT	Provean	PolyPhen HumVar (HumDiv)	Mutation assessor	Condel	Phyre2	LOH	IHC	Segregation analysis	Splice site prediction	Conclusion
-	0,9999dis easecausin g	0,000dam aging	-7,75 deleterious	0,999proba blydamagin g(1,000)	3,27mediu m	0,662034del eterious	likely to affect function (highest score)	nd	Loss of nuclear BAP1 labeling in adenocarcinoma but nuclear labeling for BAP1 was retained in the MM (No UM specimen available)	no data	Activation of an exonic cryptic donor site (Human Splicing Finder, MaxEnt)	Disease causing
c.233A>G(p.Asn78Ser) (exon 4) 52442512T>C				[6] ABS2570 Kidney Ca, MM in carriers / Gastic Ca x4 in otherfamilymembres								
-	0,9999dis easecausin g	0,06tolerat ed	-3,80 deleterious	0,608possi blydamagin g(0,767)	0,7 neutral	0,442072ne utral	unlikely to affect function (high score)	nd	nd	no data	Activation of an exonic cryptic donor site (Human Splicing Finder, MaxEnt, BDGP, NetGene2, GeneScan, FSPLICE); Activation of an exonic acceptor site, with one or more cryptic branch point(s) (Human Splicing Finder	Disease causing
c.1748C>T (p.Ser583Leu) (exon 14)3:52437296G>A				[6] ABS3313 MM (67), BCC in carrier / CM in otherfamilymember								

BAP1 missense variants (exon) Genomic position on chr3				[Ref] Case ID Tumors in patients with BAP1 variants (Age of diagnosis) and in untested family members								
1000G ExAC	Mut taster	SIFT	Provean	PolyPhen HumVar (HumDiv)	Mutation assessor	Condel	Phyre2	LOH	IHC	Segregation analysis	Splice site prediction	Conclusion
- 1 het 6503 All	0.9871dis easecausin g	0,38tolerat ed	-0,84 neutral	0,001benig n (0,001)	0,345 neutral	0,451540ne utral	unlikely to affect function (high score)	nd	nd	no data	New acceptor site (MaxEnt)	VUS
c.1147C>T (p.Arg383Cys) (exon 12)3:52438572G>A				[6] ABS3023 MM in carrier / Breast Ca in otherfamilymember								
1 het 6502 All5 het (4.471e -05)	0,9999dis easecausin g	0,03 damaging	-2,51 deleterious	0,990proba blydamagin g(1,000)	1,845 low impact	0,489999ne utral	unlikely to affect function (high score)	nd	nd	no data	No alterations	VUS
c.1700A>C (p.Asp567Ala) (exon 13) 52437461T>G				[this work] ID16 CM (28, 28), Cutaneous lymphoma NH-B (57) in carriers /								
-	0,9999 diseasecau sing	0,003 damaging	-1,71 neutral	0,696 possiblyda maging (0.976)	0,975 low impact	0,48069 neutral	unlikely to affect function (high score)	Melanoma sample show a decreased amount of the paternal allele, suggesting the loss of the wild type allele	Two different melanomas of the index case show the normal BAP1 expression in the nucleus	Variant does not unconditionally track with the disease	No alterations	VUS
More frequent missense variants reported in ExAc (heterozygote, homozygote and total individuals of the population at higher frequency)												

BAP1 missense variants (exon) Genomic position on chr3				[Ref] Case ID Tumors in patients with BAP1 variants (Age of diagnosis) and in untested family members								
1000G ExAC	Mut taster	SIFT	Provean	PolyPhen HumVar (HumDiv)	Mutation assessor	Condel	Phyre2	LOH	IHC	Segregation analysis	Splice site prediction	Conclusion
c.121G>A (p.Gly41Ser) (exon 3) 3:52443571C>T				nn								
78 het 2.506 Asn	0,9999 diseasecau sing	0,369 tolerated	-3,12 deleterious	0.078 benign (0,078)	0,049 neutral	0,458715 neutral	unlikely to affect function (high score)	-	-	-	New cryptic donor site (MaxEnt)	VUS / Likely benign
c.869A>G (p.Asn290Ser) (exon 10) 3:52439843T>C				nn								
54 het 5.772 Lat	0,9998 poly- morphism	1,000 tolerated	-0,57 neutral	0.000 benign (0,000)	neg score neutral	0,332615 neutral	unlikely to affect function (highest score)	-	-	-	No alterations	Likely benign
c.1201T>G (p.Tyr401Asp) (exon 12)3:52438518A>C				nn								
20 het 60.059 All	0,9999 diseasecau sing	0,537 tolerated	-2,12 neutral	0.186 benign (0,437)	0,095 neutral	0,491095 neutral	unlikely to affect function (highest score)	-	-	-	No alterations	VUS / Likely benign
c.1786A>G (p.Ser596Gly) (exon 14) 3:52437258T>C				nn								

BAP1 missense variants (exon) Genomic position on chr3				[Ref] Case ID Tumors in patients with BAP1 variants (Age of diagnosis) and in untested family members								
1000G ExAC	Mut taster	SIFT	Provean	PolyPhen HumVar (HumDiv)	Mutation assessor	Condel	Phyre2	LOH	IHC	Segregation analysis	Splice site prediction	Conclusion
740 het 30 hom 5.201 Afr	0,9999 poly- morphism	0,393 tolerated	-0,01 neutral	0.000 benign (0,000)	neg score neutral	0,390318 neutral	unlikely to affect function (highest score)	-	-	-	No alterations	Benign
c.1838C>T (p.Thr613Met) (exon 14) 52437206G>A				nn								
128 het 1 hom 5.202 Afr	0,9999 poly- morphism	0,063 tolerated	-0,34 neutral	0.001 benign (0,001)	0,000 neutral	0,426829 neutral	unlikely to affect function (highest score)	-	-	-	No alterations	Benign

This table was modified from Rai et al. 2016 [16]

RCC renal cell carcinoma, CaSU, Cancer site unknown, UM uveal melanoma, MM malignant mesothelioma, CM cutaneous melanoma, BCC basal cell carcinoma, ALL Acute lymphocytic leukemia, LOH loss of heterozygosity, IHC immunohistochemistry, Nd not done, NN none, VUS variant of unknown significance.