

AperTO - Archivio Istituzionale Open Access dell'Università di Torino

## The MeteoMet2 project - highlights and results

### **This is the author's manuscript**

*Original Citation:*

*Availability:*

This version is available <http://hdl.handle.net/2318/1667420> since 2018-05-03T20:55:06Z

*Published version:*

DOI:10.1088/1361-6501/aa99fc

*Terms of use:*

Open Access

Anyone can freely access the full text of works made available as "Open Access". Works made available under a Creative Commons license can be used according to the terms and conditions of said license. Use of all other works requires consent of the right holder (author or publisher) if not exempted from copyright protection by the applicable law.

(Article begins on next page)

## THE METEOMET2 PROJECT – HIGHLIGHTS AND RESULTS

A. Merlone<sup>1</sup>, F. Sanna<sup>1a</sup>, G. Beges<sup>2</sup>, S. Bell<sup>3</sup>, G. Beltramino<sup>1</sup>, J. Bojkovski<sup>2</sup>, M. Brunet<sup>4</sup>, D. del Campo<sup>5</sup>, A. Castrillo<sup>6</sup>, N. Chiodo<sup>7</sup>, M. Colli<sup>8</sup>, G. Coppa<sup>1</sup>, R. Cuccaro<sup>1</sup>, M. Dobre<sup>9</sup>, J. Drnovsek<sup>2</sup>, V. Ebert<sup>10</sup>, V. Fericola<sup>1</sup>, A. Garcia-Benadi<sup>11</sup>, C. Garcia-Izquierdo<sup>5</sup>, T. Gardiner<sup>3</sup>, E. Georgin<sup>12</sup>, A. Gonzalez<sup>5</sup>, D. Groselj<sup>13</sup>, M. Heinonen<sup>14</sup>, S. Hernandez<sup>5</sup>, R. Högström<sup>14</sup>, D. Hudoklin<sup>2</sup>, M. Kalemci<sup>15</sup>, A. Kowal<sup>16</sup>, L. Lanza<sup>8</sup>, P. Miao<sup>2</sup>, C. Musacchio<sup>1</sup>, J. Nielsen<sup>17</sup>, M. Nogueras-Cervera<sup>11</sup>, P. Pavlasek<sup>18</sup>, M. de Podesta<sup>2</sup>, S. Oguz Aytekin<sup>15</sup>, M. K. Rasmussen<sup>17</sup>, J. del-Río-Fernández<sup>11</sup>, L. Rosso<sup>1</sup>, H. Sairanen<sup>14</sup>, J. Salminen<sup>14</sup>, D. Sestan<sup>19</sup>, L. Šindelářová<sup>20</sup>, F. D. Smorgon<sup>1</sup>, Sparasci<sup>6</sup>, R. Strnad<sup>20</sup>, M. Voldan<sup>20</sup>, R. Underwood<sup>2</sup>, A. Uytun<sup>15</sup>

*1 INRiM Istituto Nazionale di Ricerca Metrologica, Turin, Italy*

*2 NPL National Physical Laboratory, Hampton Road, Teddington, Middlesex, UK*

*3 UL-FE/LMK Univerza v Ljubljani, Ljubljana, Slovenia*

*4 C3 Centre for Climate Change, Dep. of Geography, University Rovira i Virgili, Tarragona, Spain*

*5 CEM Centro Español de Metrología, Tres Cantos, Madrid, Spain*

*6 Università degli Studi della Campania “Luigi Vanvitelli” Dipartimento di Matematica e Fisica, Caserta, Italy*

*7 LNE-Cnam Conservatoire national des arts et métiers, La Plaine Saint-Denis, France*

*8 University of Genova, Dept. of Civil, Chemical and Environmental Engineering, Italy*

*9 SMD Federale Overheidsdienst Economie, KMO, Middenstand en Energie, Brussels, Belgium*

*10 PTB Physikalisch-Technische Bundesanstalt, Braunschweig, Germany*

*11 UPC Universitat Politècnica de Catalunya Vilanova i la Geltrú, Spain*

*12 LNE-CETIAT Centre Technique des Industries Aéronautiques et Thermiques, Villeurbanne Cedex, France*

*13 ARSO - Agencija Republike Slovenije za okolje, Ljubljana, Slovenia*

*14 VTT MIKES Mittatekniikan Keskus, Espoo, Finland*

*15 TUBITAK Ulusal Metroloji Enstitüsü, Kocaeli, Turkey*

*16 INTiBS Instytut Niskich Temperatur i Badań Strukturalnych, Wrocław, Poland*

*17 DTI Teknologisk Institut, Gregersensvej, Taastrup, Denmark*

*18 SMU Slovenský Metrologický Ústav, Bratislava, Slovakia*

*19 HMI/FSB-LPM Faculty of Mechanical Engineering and Naval Architecture, Zagreb, Croatia*

*20 CMI Cesky Metrologicky Institut, Brno, Czech Republic*

### Abstract

Launched in 2011 within the European Metrology Research Programme (EMRP) of EURAMET, the joint research project “MeteoMet” – Metrology for Meteorology – is the largest EMRP consortium: National Metrology Institutes, Universities, meteorological and climate agencies, Research Institutes, collaborators and manufacturers are working together, developing new metrological techniques, as well as improving already existing ones, for meteorological observations and climate records. The project focuses on: humidity in the upper and surface atmosphere, air temperature, surface and deep-sea temperatures, soil moisture, salinity, permafrost temperature, precipitation and snow albedo effect on air temperature. All tasks are performed under rigorous metrological approach and include design and study of new sensors, new calibration facilities, investigation of sensors characteristics, improved techniques for measurements of Essential Climate Variables with uncertainty evaluation, traceability, laboratory proficiency and inclusion of field influencing parameters, long-lasting measurements, and campaigns in remote and extreme areas.

MeteoMet vision is to make a further step towards establishing full data comparability, coherency, consistency and long-term continuity, through a comprehensive evaluation of the measurement uncertainties for the quantities involved in the global climate observing systems and the derived observations. The improvement of quality of Essential Climate Variables records, through the inclusion of measurement uncertainty budgets, will also highlight possible strategies for the reduction of the uncertainty.

This contribution presents selected highlights of the MeteoMet project and reviews the main ongoing activities, tasks and deliverables, with a view to its possible future evolution and extended impact.

### Keywords:

<sup>a</sup> Corresponding author: Francesca Sanna [f.sanna@inrim.it](mailto:f.sanna@inrim.it)

Metrology for meteorology and climatology; atmospheric air temperature, humidity and pressure measurements; sea temperature and salinity measurements; albedo, soil moisture and permafrost; weather station; interlaboratory comparison.

### Glossary:

BEV/PTP	Physikalisch-Technischer Pruefdienst des Bundesamt fuer Eich- und Vermessungswesen, Austria
BIPM	<i>Bureau International des Poids et Mesures</i>
CCT	Comité Consultatif de Thermométrie
CEM	Centro Espanol de Metrologia, Spain
CETIAT	Centre Technique des Industries Aerauliques et Thermiques, France
CIMO	Commission for Instruments and Methods of Observations
CMCs	Calibration Measurement Capabilities
CMI	Cesky Metrologicky Institut Brno, Czech Republic
CNAM	Conservatoire National des Arts et Metiers, France
CSIC	Agencia Estatal Consejo Superior de Investigaciones Cientificas, Spain
CTD	Conductivity, Temperature and Depth
DTI	Teknologisk Institut Denmark, Denmark
ECVs	Essential Climate Variables
EDIE	Earth Dynamics Investigation Experiment
EMRP	European Metrology Research Programme
EURAMET	European Association of National Institutes of Metrology
FBGs	Fiber Bragg Gratings
GCOS	Global Climate Observing System
GRUAN	GCOS Reference Upper-Air Network
GUM/MG	Ministerstwo Gospodarki, Poland
INRiM	Istituto Nazionale di Ricerca Metrologica, Italy
INTiBS	Institut Niskich Temperatur i Badan Strukturalnych, Poland
KCDB	Key Comparison Database
KNMI	Royal Netherlands Meteorological Institute
LMD	Laboratoire de Météorologie Dynamique
NIOZ	Royal Netherlands Institute for Sea Research
NMHS	National Meteorological and Hydrological Services
NMI	National Measurement Institutes
NPL	National Physical Laboratory, United Kingdom
OBSEA	Submarine observatory at of Vilanova i la Geltrú, Spain
ppmv	parts per million by volume
PRT	Platinum Resistance Thermometer
PTB	Physikalisch-Technische Bundesanstalt, Germany
RA	Regional Associations
SHOM	Service hydrographique et océanographique de la Marine, France
SI	International System of Units
SMD	Federale Overheidsdienst Economie, KMO, Middenstand en Energie, Belgium
sccm	standard cubic centimeters
T&RH	Temperature and Relative Humidity
TBRGs	Tipping-Bucket Rain Gauges
TDLAS	Tunable Diode Laser Absorption Spectroscopy
TUBITAK	Türkiye Bilimsel ve Teknolojik Araştırma Kurumu, Turkey
UL	Univerza v Ljubljani, Slovenia

1	UniGe	Università degli Studi di Genova
2	UPC	Universitat Politècnica de Catalunya
3	VSL	Van Swinden Laboratorium B.V., Netherlands
4	VTT MIKES	Teknologian tutkimuskeskus / Mittatekniikan Keskus, Finland
5	WMO	World Meteorological Organization
6	WOCE	World Ocean Circulation Experiment
7		
8		
9		
10		
11		
12		
13		
14		
15		
16		
17		
18		
19		
20		
21		
22		
23		
24		
25		
26		
27		
28		
29		
30		
31		
32		
33		
34		
35		
36		
37		
38		
39		
40		
41		
42		
43		
44		
45		
46		
47		
48		
49		
50		
51		
52		
53		
54		
55		
56		
57		
58		
59		
60		

# 1 INTRODUCTION

---

## 1.1 BACKGROUND

Measurements are at the core of meteorology and climatology, but typically, instruments and methods of observation in these fields have evolved – quite understandably – with extreme conservatism. Thus, great value was placed on the continuity of measurement series made using the same technique, despite questions being raised over the continued appropriateness of the measurement technique, and the availability of new techniques. Viewed from a metrological perspective, we can view this tension between conservatism and innovation as arising from a combination of two weaknesses in traditional meteorological practice.

Firstly, traditional meteorological techniques can fail to adequately characterise the measurand and thus, for example, a measurement of humidity using a wet-bulb thermometer can be strongly influenced by wind speed at the measurement station. Changing instruments or methods can result in the measurement with quite different susceptibility to other quantities, and thus introduce different error characteristics – known as an inhomogeneity – into a measurement series.

Secondly, there is often a reluctance to fully quantify the measurement uncertainty associated with a measurement. This is because the conditions of measurement are frequently so hostile that issues of conventional measurement traceability are considered of secondary importance. Additionally, measurements from around the world are rarely taken in ideal conditions with professional metrologists at hand.

Meteorologists and climatologists are well aware of these shortcomings and have developed sophisticated strategies for analysing measurement series containing inhomogeneities. Nonetheless, the situation is far from ideal.

It is in this context that the two MeteoMet and MeteoMet2 pan-European projects were created with aim of improving meteorological best practice by the application of new concepts and technology applied with a metrological perspective.

As stated by the Global Climate Observing System (GCOS), “long-term, high-quality and uninterrupted observations of the atmosphere, land and ocean are vital for all countries, as their economies and societies become increasingly affected by climate variability and change” [1]. High-quality observations are possible only if they are based on a sustained traceability to the International System of Units (SI) and with uncertainties associated to the measured ECVs.

## 1.2 METEOMET

*MeteoMet* – Metrology for Meteorology – is a Joint Research Project (JRP) of the *European Association of National Institutes of Metrology* (EURAMET). Its first phase began in 2011 [2, 3] and focussed on the traceability of a subset of Essential Climate Variables (ECVs) to the International System of Units (SI) with specified uncertainties. In 2014, the project began its second phase, *Meteomet 2*, extending the investigations to additional variables and contributions to uncertainty in field measurements. The aim is that quality improvement of the recorded ECV data will eventually lead to strategies for the reduction of the uncertainty.

The MeteoMet 1 and 2 projects involves 18 National Measurement Institutes (NMI) and 6 Designated Institutes from 20 European countries, 14 universities, 13 research centres, 14 manufacturers and private companies, and 22 hydro-meteorological agencies. It is through this combination of organisations and perspectives that the

1 project aims to translate ideas in practical implementation in the field. The project key data since the first phase  
2 is summarized in the table1 of annex I, with the full list of MeteoMet 1 and 2 partners (table 2).

3 The project is structured into three main areas of observation: Air, Sea and Land. These categorisations are  
4 really shorthand because many of the 'land' ECVs refer to measurements of the temperature and humidity of  
5 air, but specifically address measurements in meteorological stations.

6 In Section 2 below, we outline the challenges identified in the project considered in each domain: Air (Section  
7 2.1), Sea (Section 2.2) and Land (Section 2.3). Within each subsection, we list the specific work packages  
8 which respond to the identified measurement challenges along with the lead institution taking part in the  
9 research. Because MeteoMet 2 is not due to finish until the end of September 2017, as we write this paper, not  
10 all projects have been finished. However, we consider it valuable to include details to convey the scope of the  
11 work being undertaken. In Section 3, we select eight work packages for further exposition, and In Section 4  
12 we describe the anticipated impact of the project and prospects for further research.

## 17 2 TOPICS

---

### 20 2.1 AIR: HUMIDITY AND TEMPERATURE MEASUREMENTS ABOVE GROUND LEVEL

21 Climate science could be alternatively described as the study of the dynamics and thermodynamics of water in  
22 the Earth's atmosphere. Yet measurements of water vapour in air are especially problematic. Ideal sensors  
23 would be able to cover a range of specific humidity (g H<sub>2</sub>O per kg dry air) covering a factor of more than 10<sup>4</sup>  
24 and would be fast responding to quantify dynamic changes. For ground level measurement, the targets are: at  
25 23 °C and 50 %rh = 8.79 g H<sub>2</sub>O/kg dry air; at -20 °C and 50 %rh = 0.388 g H<sub>2</sub>O/kg dry air; at 40 °C and 50 %rh  
26 = 23.65 g H<sub>2</sub>O/kg dry air; and it is even lower in the upper atmosphere. However real sensors are highly non-  
27 ideal. The sensors display a significant hysteresis; they dry down considerably more slowly than they get wet;  
28 and their response time is particularly poor when the surround environment is cold. These combined  
29 shortcomings create significant measurement challenges for radiosondes, which travel from the warm, wet  
30 troposphere to cold dry stratosphere.

31 The MeteoMet consortium set the following scientific and technological objectives:

- 32 1. Development of metrological procedures to calibrate radiosondes under atmospheric conditions  
33 including reduced pressures and temperatures.
- 34 2. Measurement of the water vapour enhancement factors, which cause deviation from calculated specific  
35 humidity in air, compared to water vapour only calculations.
- 36 3. Development of new spectroscopic methodologies as standards for traceable humidity measurements  
37 and on-site references.
- 38 4. Development of a traceable humidity source capable to provide on-site calibration to airborne  
39 instruments.
- 40 5. Development of a reference instrument for the measurement of fast transients of temperature and  
41 humidity.
- 42 6. Development of traceable humidity sensors based on microwave resonators having short response time  
43 and small size.

44 In response to these identified aims, the following steps have been taken.

#### 45 2.1.1 Calibration of radiosondes under atmospheric conditions.

46 The development of a calibration facility for water-vapour measurements in radiosondes in the range from  
47 0.03 μmol/mol to 1.5 μmol/mol [4] was completed at VTT MIKES. The pressure and dew-point temperature  
48 limits were decreased down to 10 hPa (abs.) and -90 °C at VTT MIKES and 200 hPa and -95 °C at INRiM,  
49 respectively, to simulate the conditions met during the ascent in the troposphere and lower stratosphere. The  
50 calibration of a radiosonde at a single temperature can be performed within 15 h. The facility shows a very  
51 good repeatability and no hysteresis. The water vapour amount fraction uncertainty is less than 2%.

This task is described further in the ‘Highlights’ Section 3.1

### 2.1.2 Measurement of the enhancement factor under atmospheric conditions.

The CETIAT completed a literature review to identify pros and cons of different experimental set-ups. Currently two measuring methods are generally used, a direct one, by measuring the second virial coefficient, and an indirect one, by measuring humidity, therefore, studies were carried out to identify the most synergic methods with other measurements. The indirect method was chosen and an apparatus was designed. The assembly is in progress and a measurements campaign will follow. The humidity range aimed to be comprised between  $-60\text{ }^{\circ}\text{C}$  and  $10\text{ }^{\circ}\text{C}$ , and the pressure range between 400 hPa (abs.) and 1000 hPa (abs.).

### 2.1.3 On-site calibration of airborne instruments.

PTB has built a portable instrument for *in situ* calibration of airborne hygrometer with uncertainty in the (1-20) parts per million by volume (ppmv) interval. A mobile, compact, and robust water vapour generator, which uses water permeation through air-purged plastic tubing was developed and manufactured. By stabilising the gas flow and the bath temperature, a well-defined mixing ratio is achieved. Performance tests are ongoing.

### 2.1.4 Measurement of fast transients of temperature and humidity.

NPL upgraded an airborne combined acoustic thermometer and infrared hygrometer for measurement of fast transients during ascents through the atmosphere [5]. The instrument can make 30 independent readings per second with a resolution of  $0.001\text{ }^{\circ}\text{C}$  and uncertainty  $<0.1\text{ }^{\circ}\text{C}$ , measurement of water vapour mixing ratios from 10000 ppmv ( $\sim 10\%$ ) to  $3 \cdot 10^4$  ppmv (corresponding to dew points from  $-42\text{ }^{\circ}\text{C}$  to  $24\text{ }^{\circ}\text{C}$  at  $10^5$  1000 hPa).

### 2.1.5 Microwave Hygrometry

CNAM realized a prototype of a fast airborne microwave hygrometer (volume  $200\text{ cm}^3$ ) operating from  $-50\text{ }^{\circ}\text{C}$  to  $10\text{ }^{\circ}\text{C}$  (frost point temperature) and from  $-20\text{ }^{\circ}\text{C}$  to  $20\text{ }^{\circ}\text{C}$  (dew point temperature). The measurement range is from few to  $10^5$  ppmv, and the uncertainty of measurement is approximately 5 ppmv. A comparison with a CETIAT calibrated chilled-mirror hygrometer showed that it could be an alternative standard for humidity measurements (see figure 1). However, the measurement time is about 100 seconds, considered still extensive for the purpose, primarily because a long sampling tube was used. A second generation was made and the assembly of the full system is in progress.

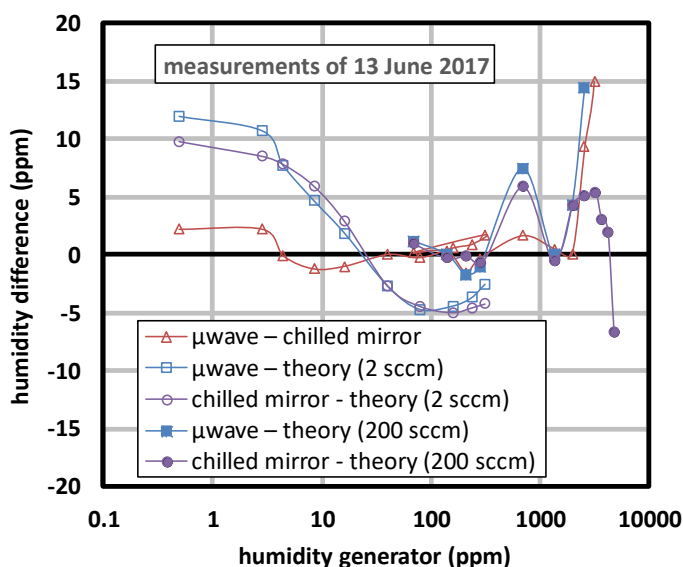

**Figure 1.** Comparison between the uncalibrated microwave hygrometer developed at CNAM and a calibrated chilled mirror hygrometer supplied by CETIAT ( $\mu$ wave – chilled mirror). sccm = standard cubic centimeters. The picture shows also comparisons of the microwave hygrometer and the chilled mirror with theoretically calculated humidity values in low flow regime (2 sccm) and high flow regime (200 sccm).

## 2.2 SEA: TEMPERATURE AND SALINITY MEASUREMENTS IN OCEANS

Temperature and salinity are two key oceanic ECVs, for monitoring and understanding decadal changes in heat content and heat transport. A comprehensive study of the characteristics of the associated measurement instruments and the effect of the main quantities of influence on thermometers and salinometers is needed, in order to reduce measurement uncertainty.

The scientific and technological objectives at the outset of the project are:

1. Development of facilities to study the pressure dependence of deep-sea thermometers and to establish validated pressure-correction models.
2. To perform a thermodynamic calibration of deep-sea thermometers, to analyse the temperature-resistance models, to estimate the uncertainties or to propose improved models.
3. Development of distributed temperature sensors based on optical Fiber Bragg Gratings (FBGs), to improve the traceability of sea-surface and sea-profile temperature measurements, and to monitor temperature drifts of the thermometers used in underwater observatories.
4. Development of a facility for determining temperature and pressure effects on salinometers based on the measurement of seawater refraction index, and their metrological characterization.

### 2.2.1 Pressure dependence of deep-sea thermometers.

VSL realised a comparison block and carried out measurements on deep-sea thermometers using a high-pressure chamber available at NIOZ (Royal Netherlands Institute for Sea Research). The pressure dependence of Sea-Bird Electronics thermistors (the biggest manufacturer and supplier of oceanographic thermometers) was measured at 500 bar (-0.30 mK / 100 bar) confirms the values observed in the sea (from -0.17 to -0.33 mK / 100 bar) and the proper operation of the facility. A pressure of 100 bar corresponds to a depth of approximately 1000 metres.

### 2.2.2 Thermodynamic calibration of deep-sea thermometers.

The CNAM modified an acoustic gas thermometer and the associated calorimeter, in order to integrate and calibrate the deep ocean thermometers from -5 °C to 35 °C, within a calibration uncertainty below 0.5 mK. Currently, the best achievable calibration uncertainties on high-grade deep ocean thermometers are close to 2 mK. They might be further reduced to meet the target overall uncertainty of 2 mK in deep ocean temperature measurements, required by the World Ocean Circulation Experiment (WOCE) Hydrographic Program<sup>b</sup>. Measurements are currently in progress at CNAM to evaluate the suitability of the most common high-grade deep ocean thermometers for such reduced uncertainty.

### 2.2.3 Ocean temperature sensors based on optical fiber Bragg gratings.

CEM, CSIC and UPC designed and assembled FBGs sensors, used as thermometers, to measure profile and near-surface sea temperatures. The onsite experiment was designed and the FBGs sensors were tested and calibrated. These thermometers were integrated into the submarine observatory (OBSEA), connected to the coast of Vilanova i la Geltrú (Barcelona, Spain) and placed at a depth of 20 meters. This task is described further in the 'Highlights' Section 3.3 and 3.4.

### 2.2.4 Test and calibration facility for refractive-index salinometers.

To make accurate *in-situ* measurements, CNAM and INTiBS created a test and calibration facility for determining temperature and pressure effects on a novel generation of salinometers allowing absolute salinity assessment. This facility is based on the refractive index of seawater and was used for investigating the impact of parameters such as temperature and pressure on the optical sensor, or temperature on the laser wavelength drift.

---

<sup>b</sup> World Climate Research Programme (WCRP), Scientific plan for the World Ocean Circulation Experiment, WMO/TD-No. 122, July 1986. <https://www.nodc.noaa.gov/woce/wdiu/wocedocs/sciplan/sciplan.pdf>

## 2.3 LAND: TEMPERATURE AND HUMIDITY MEASUREMENTS IN GROUND LEVEL MEASUREMENTS

Ground-based ECVs have been historically recorded for meteorological purposes and these records now form one of the primary tools for evaluating decadal and longer climate trends. New techniques are being developed to improve the data quality and the comparability between meteorological stations. A key focus in MeteoMet project has been the ability to make coherent of measurement uncertainty including the effects of the intrinsic sensor behaviour, and parameters of influence, including siting and thermometer screens.

An objective of the intrinsic and dynamic behaviour study of the air temperature sensors is to improve the ISO Guide 17714:2007 (Meteorology - Air temperature measurements - Test methods for comparing the performance of thermometer shields/screens and defining important characteristics), by defining calibration procedures and evaluating uncertainties through a better sensor characterisation. This will be achieved by means of different facilities, including the special wind tunnel with temperature and pressure control designed and developed by INRiM during the first three years of the project. CEM determined the self-heating effect and hysteresis effect of a selection of thermometers with different designs, covering Pt100 alone, as well as Pt100 embedded in temperature and relative humidity (T&RH) sensors. The analysis of self-heating effect were also performed at several temperatures and with the thermometers surrounded by different mediums.

These tasks are described further in the 'Highlights' Section 3.5 and 3.6.

Regarding ECV's explicitly in the land rather than just above it, permafrost temperature is classified as a parameter to investigate climate changes but, today, few measurement procedures report a fully detailed uncertainty budget. Similarly, calibration and measurements standards for precipitation and soil moisture are not yet developed to cope with the differences between laboratory setups and field conditions.

In response to these challenges, the consortium set the following scientific and technological objectives:

1. Analysis of the siting influence on air temperature measurements in terms of uncertainty components.
2. Determination of the influence of rain and albedo on air temperature measurements.
3. To evaluate the intrinsic behaviour of thermometers and humidity sensors plus radiation shields to define calibration procedures and methods to evaluate the measurement and calibration uncertainties.
4. To ensure consistency and coherence of meteorological measurements carried out in different places.
5. Development of procedures for traceable dynamic calibrations and uncertainty calculation of hygrometers used to measure the humidity near the Earth surface.
6. Development of a high-bandwidth humidity generator to study the response of air-humidity sensors to fast humidity changes.
7. To identify the needs of traceability and uncertainty calculation of soil moisture measurements and to carry out initial experimental trials of the relevant procedures.
8. Indications of consistent measurement uncertainties in meteorological humidity data sheets.

### 2.3.1 Influence of obstacles on meteorological sites

The World Meteorological Organization-Commission for Instruments and Methods of Observations (WMO-CIMO) Guide n.8 [6] establishes a classification to help determine the ground based observation site's representativeness on a small scale. This classification associates a discrete uncertainty value/level to temperature measurements carried out in sites where exposure rules are not fully met. The work here described aimed to quantitatively evaluate uncertainty for some of the influences of siting parameters on temperature measurements: closeness to trees, buildings and asphalt roads. INRiM defined a protocol to study the influence of such obstacles on surface-based air temperature measurements that received positive feedback by the WMO Expert Team on In-situ Operational Technologies. Three experiments were carried on to improve the uncertainties associated to the presence of obstacles close to the stations and sensors in field. In Italy, an experiment is running to evaluate the road influence; in the Czech Republic a second one for tree influence; in Spain, for buildings influence. The experiments are based on identical setup and measurement protocols used to by quantify the temperature difference measured close to the obstacles and along seven measuring points



1 up to 100 m of distance in open field. The overall goal is a providing WMO CIMO Expert team input for  
2 revising the values and prescriptions adopted by the CIMO guide.  
3

### 4 **2.3.2 Albedo radiation and rain effect on meteorological thermometers in screens**

5 Thermometers use for meteorological measurements of air are normally housed in solar shields to avoid direct  
6 sun radiation introducing biases and errors in the measurement accuracy. Beside the direct solar radiation,  
7 other effect can introduce deviations from the measurement results and the air temperature value. While the  
8 effect due to the ageing of the solar shields and the associated decrease of the reflecting properties of the white  
9 painting was investigated in the previous phase on MeteoMet1 [7], in this project the effects of rain and albedo  
10 from a snow covered surface are quantified, to be included as uncertainty components in the air temperature  
11 measurements. About rain, the study is based on the fact that when rain fall on the screen housing the  
12 thermometers, an overcooling due to the lower rain drop temperature with respect to the air temperature can  
13 introduce errors in the temperature recorded. DTI assessed this influence by designing and assembling an  
14 experimental system able to generate rain drops at a known temperature in a volume with air temperature  
15 accurately measured.  
16

17 Operators of weather stations in areas where snow occurs normally observe a raise in the temperature values  
18 during sunny days in presence of snow below the measuring area. A part of this phenomenon is the natural  
19 warming of the air due to the heat diffused by the reflected radiation, the albedo from the snow covered surface,  
20 and it is not the subject of this study, since it is part of the meteorological measurand characteristics. A further  
21 component is not dependent on natural phenomena: this is the overheating of the sensor due to the reflected  
22 radiation form the snow covered surface. This effect is strongly dependent on the geometry and characteristics  
23 of the shield and sensor and can be different up to more than a degree Celsius on the measured temperature  
24 values. INRiM and BEV identified a mountain site to investigate this effect of albedo from a snow covered  
25 surface on temperature measurement and made it operational. Five pairs of shielded temperature sensors, with  
26 both naturally aspirated and mechanically ventilated shields, were used to ensure a representative group of  
27 devices. Tests were performed to evaluate the “zero” difference between each pair, as well as the necessary  
28 corrections and the relevant uncertainties. The measurements are in progress.  
29

30 As a further study, SMD made the model of the temperature measurement conditions inside a radiation shield.  
31 The model described the temperature gradient occurring in Stevensons screens under wind and radiation  
32 conditions and heat reflected for the soil. Data is being analysed and validated thanks to 3-year in-field  
33 experiment made by KNMI with 10 different radiation shields.  
34

### 35 **2.3.3 Inter laboratory comparison**

36 UL defined a protocol for the Inter-Laboratory Comparison (ILC) of temperature, humidity, and pressure  
37 internal standards of calibration laboratories of the National Meteorological and Hydrological Services  
38 (NMHS) [8]. The WMO made the protocol as an official document of its CIMO. Beyond the MeteoMet2 tasks,  
39 ILC with two loops of the ILC was organised using this protocol, with 18 National meteorological agencies  
40 participating [9] in the European Regional Associations (RA-VI). The equipment used in both loops exhibited  
41 stability and uncertainty, which enabled full evaluation of the participating laboratories capabilities. In the  
42 field of temperature, out of 270 submitted results, three laboratories had 5 results with  $|En| > 1$ . In the field of  
43 relative humidity, out of 117 submitted results, only one laboratory had 5 results with  $|En| > 1$ , [10]. In the  
44 field of pressure, out of 784 submitted results, only three laboratories had results with  $|En| > 1$ . It was strongly  
45 recommended that all the laboratories with unsatisfactory results, carefully checks their procedures for any  
46 potential systematic error, to check traceability of their references and to check their uncertainty budget to  
47 comply with used equipment and procedures as well as state of the art. The results of other participating  
48 laboratories were satisfactory. For the current state of the art in calibration of any instrument, it was advised  
49 that it is worthwhile to check BIPM KCDB (*Bureau International des Poids et Mesures*, Key Comparison  
50 Database) annex C, for the Calibration Measurement Capabilities (CMCs) of the best national metrology  
51 laboratories. Some of the uncertainties of the participating laboratories were on the level of the best national  
52 metrology laboratories.  
53  
54  
55  
56  
57  
58  
59  
60

1 It is expected that the ILC will be extended also to other WMO regions outside Europe. First expressed interest  
2 was from RA-II and RA-V (Japan, Australia, Philippines, China) and later potentially to the African region.  
3 All the results of all potential ILCs could be linked to the results in the European region (RA-VI).  
4

#### 5 **2.3.4 In situ calibration**

6 Transportable facilities were studied and manufactured, during the first phase of MeteoMet project, for the  
7 calibration of weather sensors on site. This calibration chamber, called *Earth Dynamics Investigation*  
8 *Experiment 1* (EDIE1), is capable of simultaneous and independent control of pressure and temperature. The  
9 facility is also designed to allow the control in humidity, therefore completing the characterization of the whole  
10 AWS pressure–temperature–humidity modulus. [11]. One of the greatest benefits of this facility is the reduced  
11 dimensions that makes it transportable for *in situ* calibration campaigns, also in remote areas [12]. Indeed, the  
12 facility was used in challenging missions and activities at high altitude in Himalaya and in the Arctic [13, 14].  
13  
14  
15

#### 16 **2.3.5 Historical records**

17 Historical temperature records for climate trend evaluations have also been a subject of the project: studies  
18 were made on the effect of change in instrumental methodologies on daily minimum and maximum recorded  
19 values, showing non-negligible and non-unique effects [15]. Direct calibration of historical sensors without  
20 interrupting the series were made on site of centennial stations [16]. This work illustrates one of the first  
21 examples of air-temperature data traceable to SI standards recorded in a historical series and indicates that the  
22 application of the calibration function to correct data influences the climatological analysis.  
23  
24

#### 25 **2.3.6 Agro-meteorology**

26 Metrology applied to agro-meteorology was also developed since the first phase of the MeteoMet project, in  
27 terms of evaluating the effect of the calibration's uncertainty inclusion on the meteorological measurements  
28 used as input values on epidemiological forecasting models [17]. The EDIE facility (see 2.3.4) were used to  
29 calibrate the air temperature sensors. During the second phase of the MeteoMet project, the studies moved to  
30 the weather monitoring instruments installed on hill and mountain agricultural sites. These instruments are  
31 often forced into non-ideal positioning due to slopes, tree proximity and other obstacles that primarily affect  
32 relative humidity, temperature, and solar radiation measurements. The enclosure of the instrument positioning  
33 contribution in forecasting models affected positively the disease prediction [18].  
34  
35  
36

#### 37 **2.3.7 Dynamic calibrations of hygrometers.**

38 A new water vapour generator was delivered to PTB and was integrated into a calibration facility. A climatic  
39 chamber reaching low temperatures (typically -60 °C) is operational at CETIAT. In collaboration with  
40 *Laboratoire de Météorologie Dynamique* (LMD), satisfactory response time measurements were made with  
41 the LMD hygrometer and also with a chilled mirror instrument.  
42

43 The humidity generator is capable of fast step changes in order to study the response of air humidity sensors.  
44 The facility is composed by a source of humid air generation, a source of dry air, a divider plate and a testing  
45 chamber set in a climatic chamber reaching low temperature (-60 °C). The divider plate is equipped with high-  
46 speed valves allowing switch from one humidity to another in few hundreds of milliseconds. Two hygrometers,  
47 with and without shields, were tested among chilled mirror, impedance hygrometer silicon oxide based. PTB  
48 and LNE-CETIAT are working on the interface of a measuring ring, developed at PTB, and testing chamber,  
49 developed at LNE-CETIAT, for having high accurate and high-speed reference instrument, Tunable Diode  
50 Laser Absorption Spectroscopy (TDLAS) type or spectroscopic type, close to the device under test.  
51

52 This task is described further in the 'Highlights' Section 3.7.  
53  
54

#### 55 **2.3.8 Precipitation and soil moisture.**

56 UniGe and associated Research Excellent Grant analysed a typical calibration system for tipping-bucket rain  
57 gauges (TBRGs), using the gravimetric method, in accordance with the recommendations and requirements of  
58 both meteorology and metrology. As a result, major contributions of the type B uncertainty in the calibration  
59 of TBRGs are due to the weighing system calibration (1.68 %) and resolution (0.74 %). Dimensionally,  
60 rounding off errors in the conversion from inches to millimetres were observed. It was evaluated that an

1 uncertainty of 1 mm in measuring the diameter of the collector results in 0.58 % of the calibration uncertainty  
2 contribution [19].  
3

### 4 **2.3.9 Soil Moisture Measurements**

5 TUBITAK realized a soil moisture measurement set-up based on a gravimetric method and composed by a  
6 moisture analyser, a high precision balance, a desiccator, and an oven supplemented with a rotary pump. The  
7 online survey is left open so that more responses can be collected. The INRiM completed a literature search  
8 on soil moisture measurements and calibration methods focus on agriculture and traceability requirements. It  
9 turned out there are a number of issues with the calibration, i.e. the soil used for calibration that may not  
10 represent the characteristics of the soil to be measured by the technique being calibrated. The calibration is  
11 also affected by other factors such as soil temperature, barometric pressure, salts and air gaps in soil as well as  
12 the bulk density of the soil.  
13

14 NPL collected the Met Office, the United Kingdom's national weather service, datasets of weather station  
15 hygrometer calibrations from 2012 to 2014 and added it to the initial subset of already analysed data for  
16 estimates of the drift.  
17  
18

### 19 **2.3.10 Soil Moisture questionnaire**

20 The NPL performed a survey on the measurements (about 100 respondents) and the needs of calibrations. The  
21 soil moisture questionnaire was designed to address the applications of soil moisture measurements,  
22 techniques, calibration methods (classical gravimetric method and remote sensing techniques). 25 questions  
23 were prepared, 23 of which were technical and the questions were divided into five macro areas: application,  
24 measurement, calibration, classical gravimetric method and remote sensing techniques. Potential participants  
25 for the questionnaire were identified from numerous sources. The answers to the questionnaire were  
26 automatically sent to NPL and the survey results were reported separately. In conjunction with VSL, INRiM  
27 contributed in circulating the questionnaire to over 350 contacts. MIKES, involved with steering the planning  
28 and realising the survey, is using the outcomes to improve the traceability of soil moisture sensors.  
29  
30  
31  
32

## 33 **3 SELECTED HIGHLIGHTS.**

---

### 34 **3.1 SI TRACEABLE HUMIDITY CALIBRATIONS FOR RADIOSONDES**

35 Radiosondes provide an economical method to measure vertical humidity profile in the troposphere and lower  
36 stratosphere, an activity, which is vital for weather forecasts and climate change monitoring.  
37

38 Specific challenges include:

- 39 • insolation
- 40 • wetting of sensors
- 41 • Slow drying of sensors

42 To improve the quality of upper-air humidity data, the GCOS specified a challenging uncertainty requirement  
43 for humidity measurements (2 % in the water vapour mixing ratio) [20]. Traceability to the SI is an essential  
44 requirement for achieving the target uncertainty. To enable SI-traceable humidity calibrations of radiosondes  
45 at upper-air equivalent conditions, a new humidity calibration facility was developed by the Centre for  
46 Metrology MIKES at the VTT Technical Research Centre of Finland. In this facility, a humidity radiosonde  
47 probe can be calibrated at air temperature from -80 °C to 20 °C, dew/frost-point temperature from -90 °C to  
48 10 °C and absolute air pressure from atmospheric pressure down to 10 hPa corresponding to an altitude of  
49 approximately 30 km.  
50

51 One target of the system development was to reduce stabilisation time in the measurement chamber to enable  
52 feasible calibration times. This was achieved by an appropriate measurement chamber design [21] and by  
53 applying flow mixing in a two-saturator humidity control setup [4, 22] illustrated in figure 2.  
54  
55  
56  
57  
58  
59  
60

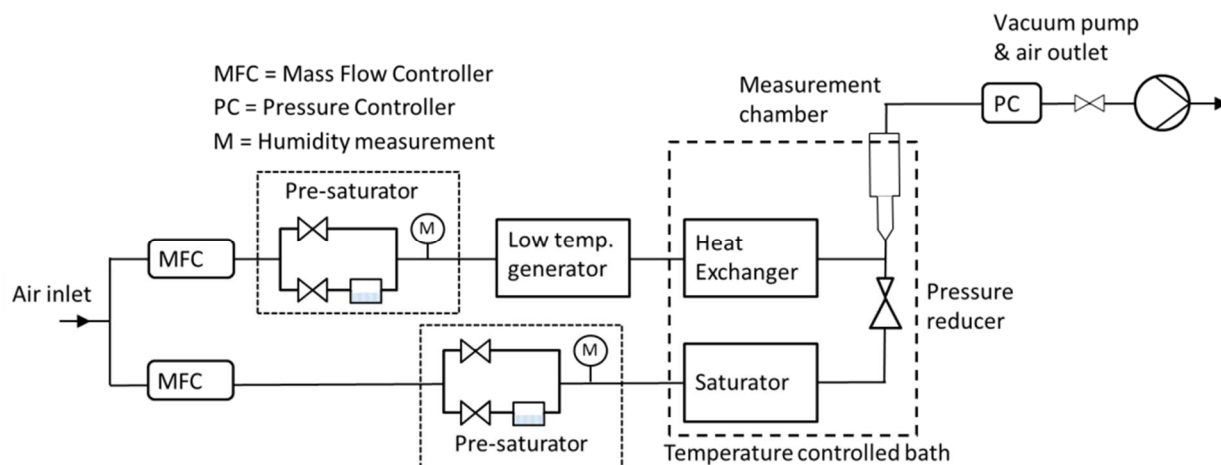

**Figure 2.** Schematic diagram of the facility developed by VTT MIKES for humidity calibrations of radiosondes.

The apparatus was fully characterised at surface pressure level and the uncertainty analysis showed that the target uncertainty of 2 % is achieved with this system. The characterisation will be completed with a comparison to be carried out with the recently commissioned INRiM standard frost point generator at sub-atmospheric pressure in the near future.

### 3.2 A CORRECTION FOR THE TEMPERATURE HISTORICAL SERIES

Daily temperature-time series, spanning over 300 years were created in particular locations and these records have allowed for the creation of climate system models of the Earth, which are used to define the long-term temperature trends and are employed for the calibration of proxies used for temperature prediction further back in time.

Prior to the 1850s, the number of continuously operated observation stations declines considerably and the creation of reliable datasets is therefore difficult. A new international temperature scale was introduced in 1927, which was truly internationally, accepted and used. The scale evolution did not stop at this point and as knowledge of thermodynamic temperature improved, a series of practical temperature scales were introduced. However, such changes introduces a small bias in long-term temperature records, which is mostly overlooked in meteorological literature. Therefore, the determination of the scale correction from 1927 to the present day is relevant when trying to estimate historical temperature trends.

The difference in temperature scales that causes the problem in historical data analysis originates from the variety of interpolating instruments, scales temperature range, fixed points and mathematical equations, used to define the instruments output relation to temperature change. The net results is small, with changes in the range  $-20\text{ }^{\circ}\text{C}$  to  $+20\text{ }^{\circ}\text{C}$  being less than  $\pm 0.02\text{ }^{\circ}\text{C}$  (figure 3), which is typical of the calibration uncertainty of meteorological thermometers. However, the result will show up as a bias when large numbers of thermometers are averaged. A software tool was developed during the first phase (2011-2014) of MeteoMet [23], allows old temperature data series to be converted into ITS-90 values for a more robust comparability.

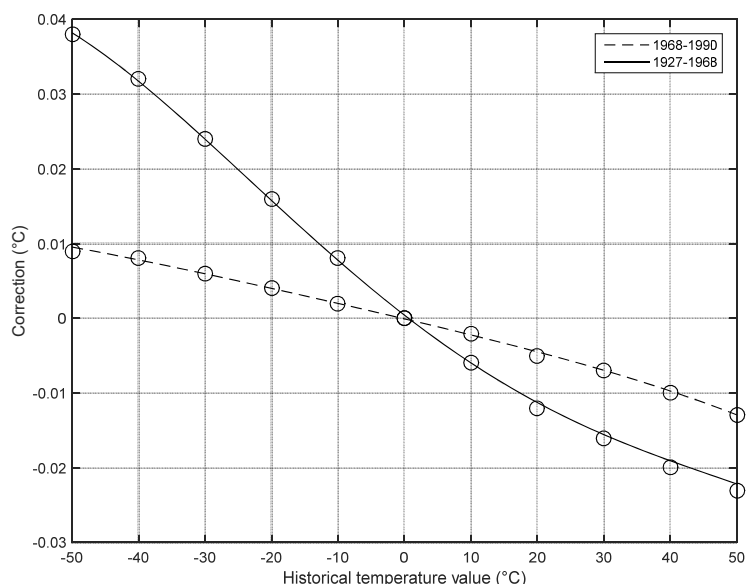

**Figure 3.** Corrections are necessary to adjust historical temperature data in order to be consistent with the modern temperature scale. The circles indicate the tabulated points from the BIPM documents describing the transforms from old scales to newer scales.

### 3.3 EXPERIMENTAL SEA TEMPERATURE PERFORMED BY FIBER OPTICS

A new technique to perform traceable temperature measurements in seawater was studied, designed, developed and tested in field by CEM, CSIC and UPC [24, 25].

The thermometers consist of several FBGs installed at different points along the optical fibers. One fiber has 3 points of measurement and the other one has 10 points of measurement. The FBGs are written on single mode optical fiber SM-ITU652 coated with acrylate. The fiber is placed inside a ¼" x 0.35 mm wall thickness, 316L stainless steel tube, in order to protect the fiber optics from the corrosive environment of seawater, as well as to give robustness to the system. The final encapsulation is done with a layer of polypropylene/PEEK with resistance to seawater.

Seawater temperature profile and the sea surface temperature were measured in the submarine observatory ([www.obsea.es](http://www.obsea.es)) (figure 4) and the devices examined for check the drift over the exposure lifetime. In order to correlate the temperature with the reflected wavelength by each Bragg gratings, the fiber optics were calibrated as a thermometers. The calibration results of one assembled fiber optic is shown in Figure 5.

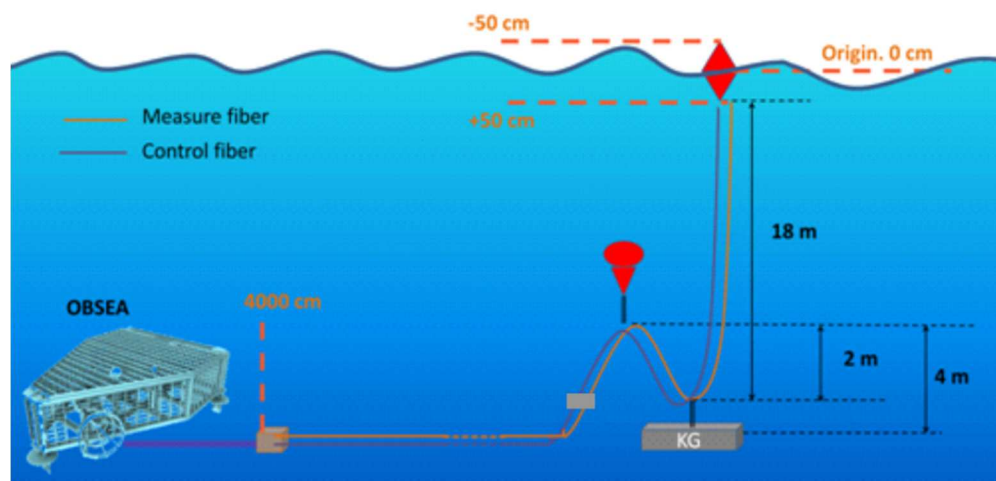

**Figure 4.** Design of the on-site experiment

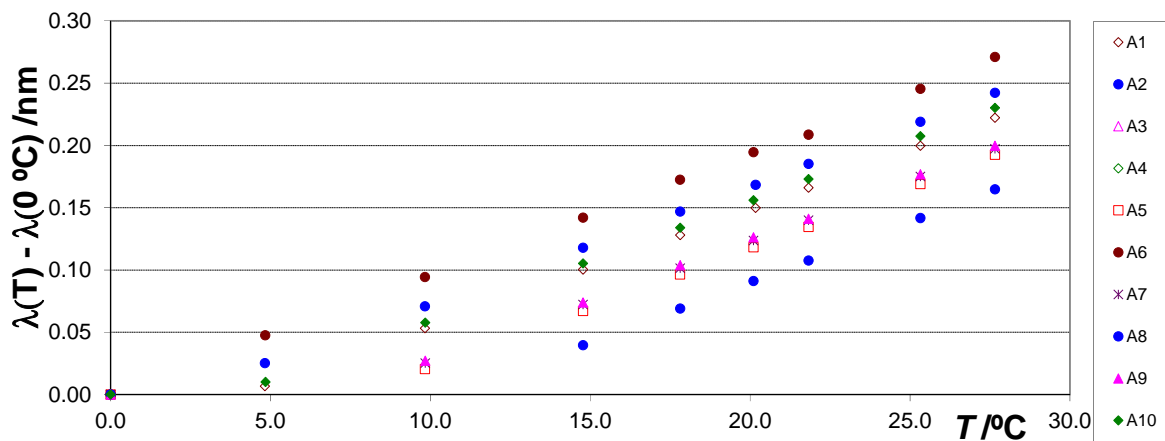

Figure 5. Calibration results of the fiber Bragg grating calibrated as a thermometer.

### 3.4 CALIBRATION OF CONDUCTIVITY, TEMPERATURE AND DEPTH SENSORS

The temperature sensors located in submarine observatory for the measurement of salinity, temperature and depth (Conductivity, Temperature and Depth, CTDs) were calibrated at CEM. Specifically, Sea-Bird Electronics, models 16plus and 37SMP (with dimensions, 808 x 136 x 103 mm and 564 x 103 x 67 mm, respectively). These instruments are currently in use in the OBSEA submarine observatory. Due their dimensions, a large calibration bath was designed, assembled and characterized at CEM. The bath shows a stability and uniformity of 35 mK in the calibration range (0 - 30) °C of the CTDs. A calibration procedure were developed with a complete calibration uncertainty model [26].

### 3.5 SELF-HEATING EFFECT OF METEOROLOGICAL TEMPERATURE SENSORS

An important issue to be considered among the uncertainty budget components of air temperature measurements is the self-heating of resistance sensors. This influence is usually determined in calibration laboratories under fixed conditions of temperature, humidity and air speed. These conditions are highly variable when the thermometer is performing measurements on site and under real environmental conditions. In addition, the resistance thermometers sometimes are used with different measuring currents during their calibrations.

CEM evaluated the correction of the self-heating effect of some resistance thermometers used for meteorological and climate applications. The dependence of the self-heating effect with electrical current, temperature and surrounded environment was analysed.

Figure 6 shows the dependence of self-heating effect with the surrounding medium, as well as the dependence with the electrical current applied to the platinum resistor for one of the evaluated thermometer. The self-heating effect depends on the design of the Platinum Resistance Thermometer (PRT), it changes with the square of the electrical current applied to the resistance element of the thermometer and it changes strongly with the surrounding environment. [27, 28].

Moreover, CMI evaluated the self-heating effect under different wind speeds of four temperature sensors in the wind tunnel developed at INRiM laboratories (figure 7).

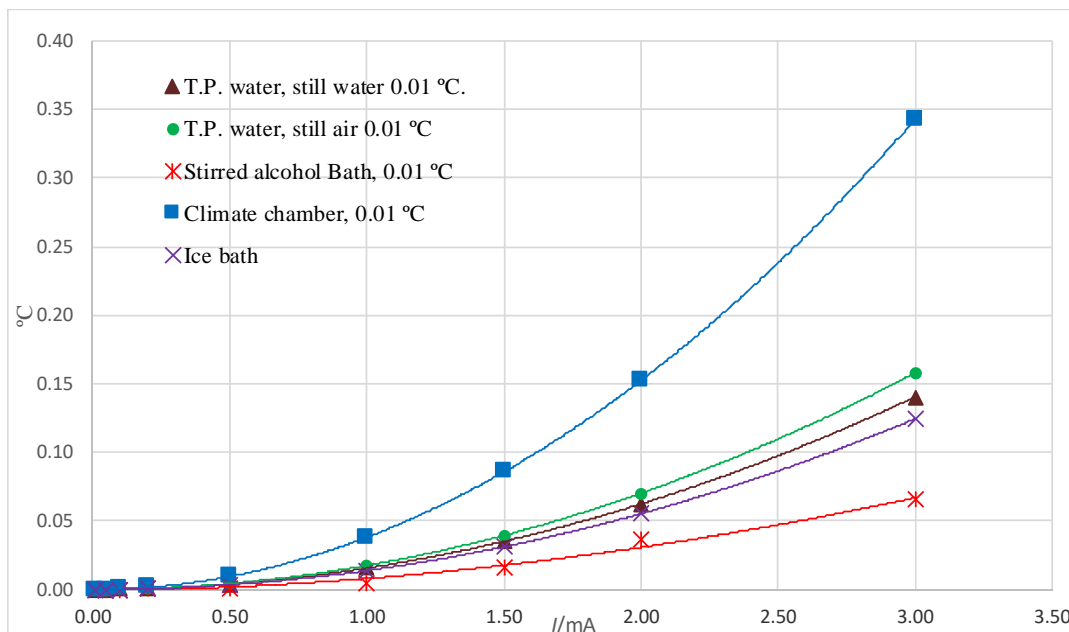

**Figure 6.** Dependence of the self-heating effect in a PRT with the electrical current applied to the resistance sensing element of the thermometer and dependence of the self-heating effect with the medium surrounding the thermometer

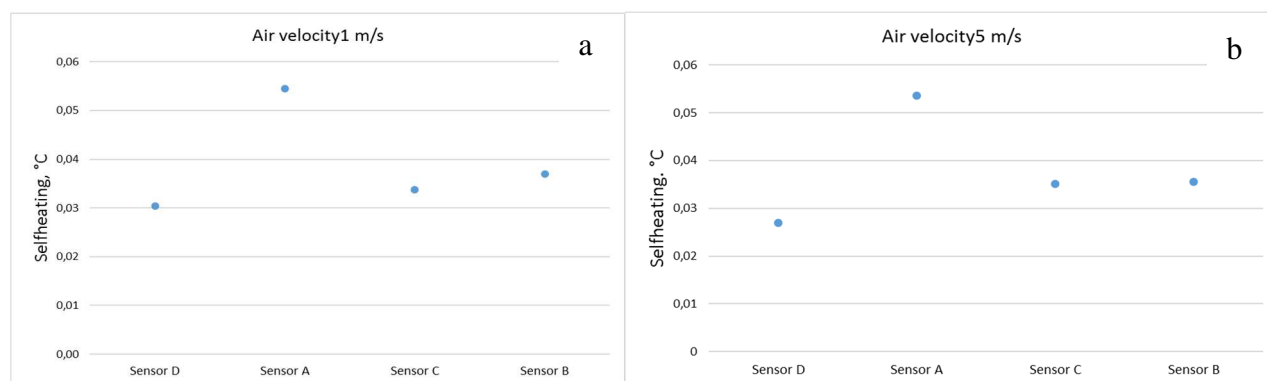

**Figure 7.** Self-heating effect under different wind speeds at  $1 \text{ ms}^{-1}$  (a) and  $5 \text{ ms}^{-1}$  (b)

### 3.6 EVALUATION OF THE HYSTERESIS EFFECT OF SOME METEOROLOGICAL THERMOMETERS

The hysteresis effect, the characteristic of a delayed reaction system to the applied stresses and in dependence on the previous state, was evaluated in a set of thermometers used in meteorological and climate application [29].

Two different methods were applied: in the first one the thermometers were exposed to a cycle of temperature increasing variation from  $10 \text{ }^\circ\text{C}$  to  $50 \text{ }^\circ\text{C}$  and, in a second stage, to temperature decreasing from  $50 \text{ }^\circ\text{C}$  to  $10 \text{ }^\circ\text{C}$  (Figure 8). Readings of the thermometer were taken at several intermediate points of the cycle.

In the second method, the thermometers were checked at the ice melting point of water after their exposure to  $10 \text{ }^\circ\text{C}$  and to  $50 \text{ }^\circ\text{C}$ . For each extreme temperature, measurement were performed 5 times (figure 9).

From figures 8 and 9, it can be deduced that the evaluation of the hysteresis effect is similar by the two methods analysed, even though the first one was more time consuming.

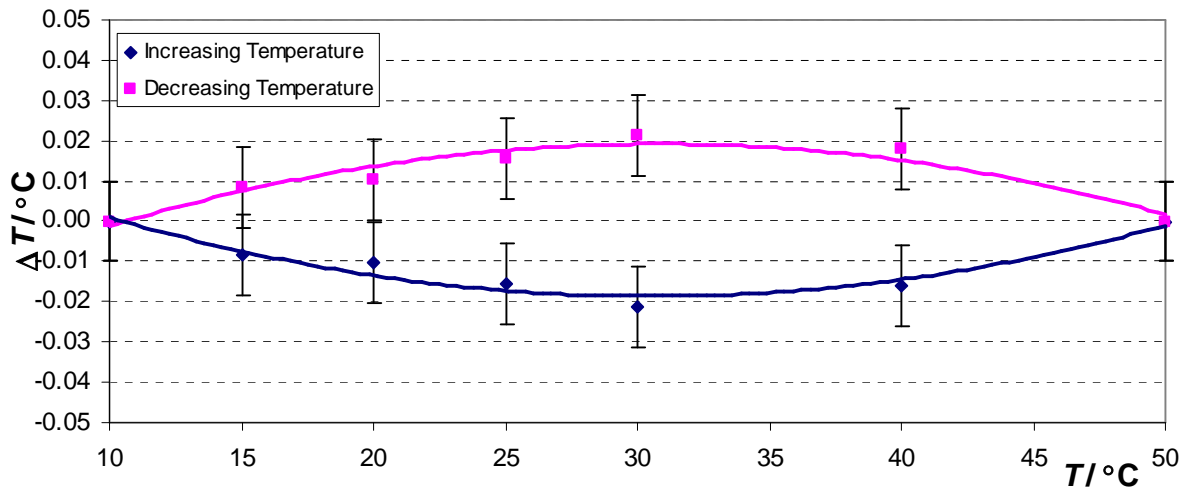

**Figure 8.** Hysteresis effect of a Pt100 measured in a stirred liquid bath. Complete cycle (10 °C and 50 °C).

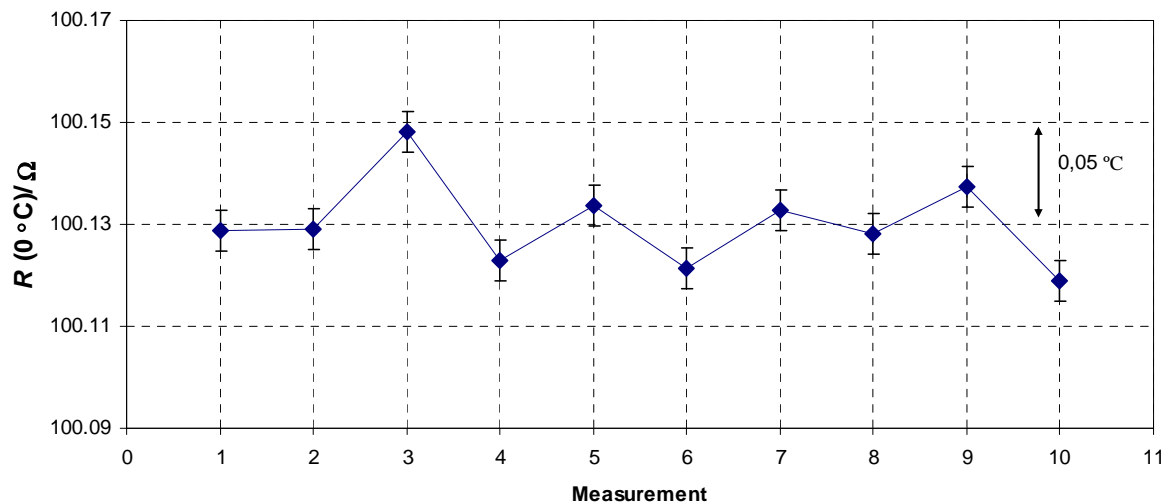

**Figure 9.** Hysteresis effect of a Pt100 measured in an ice bath, after exposure to extreme temperatures (-60 °C and 50 °C)

### 3.7 RESPONSE TIME OF HYGROMETER

The dynamic response of hygrometer was barely investigated in past studies. Often, manufacturers give an indication of the response time of the sensing element itself for a given temperature level. The response time at 63 %rh, or sometimes at 90 %rh, represents the length of time required, to the instrument, for reaching 63 %rh, or 90 %rh, of the final value that will be reached in steady state regime. In order to investigate response time behaviour of hygrometers, LNE-CETIAT has developed a facility composed by humid air generator associated to a divider plate and a testing chamber set in a climatic chamber (see figures 10 and 11). The divider plate is equipped with high-speed valves allowing switch from one humidity measurement to another in few hundreds of milliseconds. The climatic chamber enables to perform measurements at different temperature levels. This facility allowed to apply a humidity steps to the device under calibration, is called DUC.



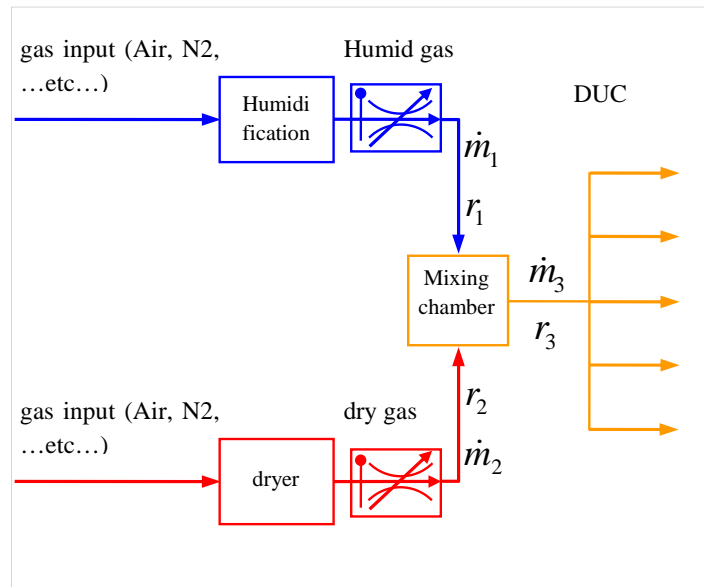

Figure 10. Schematic drawing of humid air generator based on dilution principle

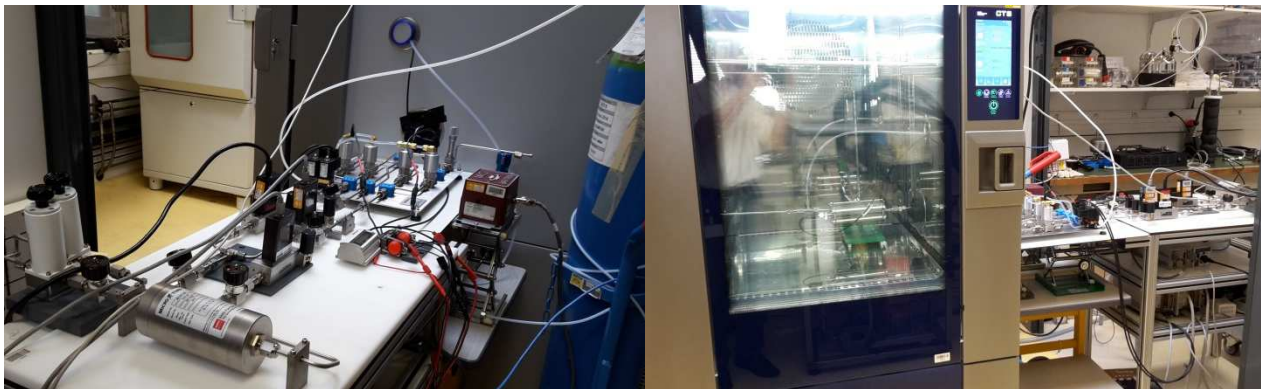

Figure 11. Overview of facility, from the left to the right, humid air generator, divider plate, climatic chamber with testing chamber

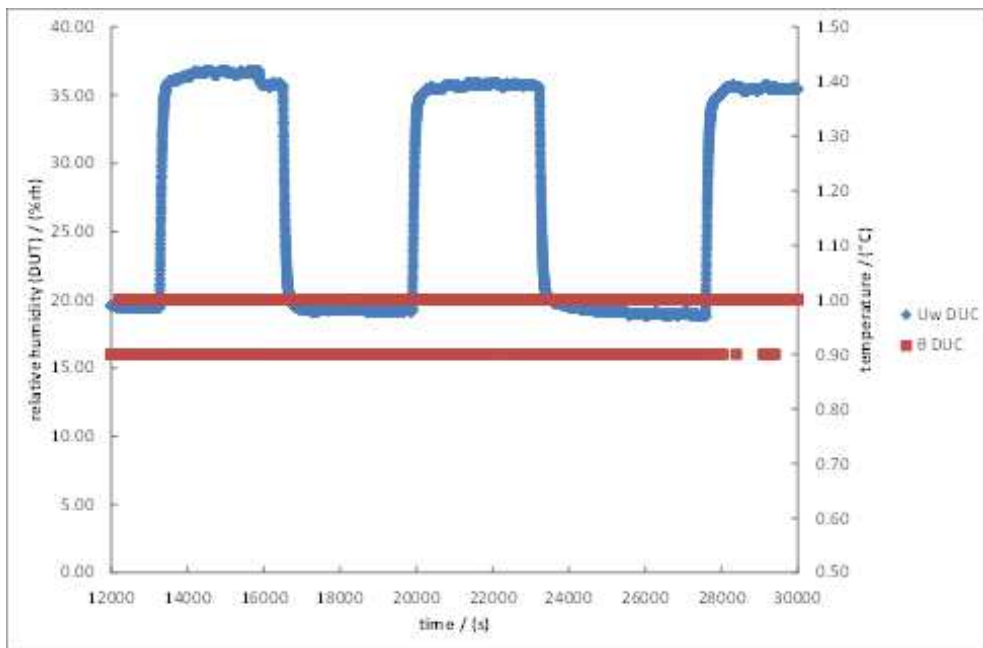

Figure 12. Humidity and temperature measured by DUC

As presented on Figure 12, humidity steps measured by DUC are recorded as well as temperature with an acquisition period of 1 point per second. Changes in humidity do not affect temperature stability, which remains within 0.1 °C. Thanks to the position transducer, it is possible to detect the time at which valves have commuted, that is to say the time at which humidity has changed from one level to another.

Table 1 presents results obtained for one hygrometer, equipped with its own filter, set at two different temperature levels: -10 °C and 10 °C. For each temperature level, measurements were repeated three times. Measurements seem to be more reproducible at higher temperature than at lower temperature. Nevertheless, the scattering could be also related to the filter surrounding the DUC or detection steady state value. From these preliminary results, it appears that response time is decreasing when surrounding temperature is increasing and response time is smaller when humidity change is increasing than when humidity change is decreasing.

**Table 1.** Results obtained for one hygrometer set at two different temperature levels

	Temperature -10 °C	Temperature 10 °C
$t_{90\%}$ (s) increasing humidity	324	148
	333	158
	353	158
$t_{90\%}$ (s) decreasing humidity	364	199
	380	192
	374	204

### 3.8 PERMAFROST SENSOR DYNAMIC

The dynamic temperature response of permafrost sensors from different manufacturers, types and constructions is a matter of some interest. Permafrost temperature measurements are currently reported without associated uncertainties, making the information difficult to evaluate in metrological terms. Therefore, knowing the dynamic response of the sensor is relevant to complete the uncertainty budget. Sensor dynamic gives to the user valuable information, which can significantly affects the decision on frequency of recording. Overestimating or underestimating the recording times can affect temperature measurements in such a way that the daily maximum and minimum values most likely be unrecorded.

Four types of sensors were tested in laboratory conditions. The dynamic response was tested by exposition to a shock temperature change from -30 °C to 30 °C and from 30 °C to -30 °C. The test was performed in air, with no ventilation, to better represent the measurement conditions in the permafrost boreholes. The introduction of sensors to a temperature shock began after their indicated temperature was stable for a minimum of 10 min. Then, the equilibrium time was measured together with the behaviour of the sensors temperature output and a minimum of five runs were performed. The temperature conditions were monitored by a calibrated reference PRT. The thermal shock was also conducted in a reversed order to see if there was any difference in their response time. Figure 13 shown a typical dynamic test result. It can be observed how fast the sensor achieve equilibrium and the typical curve of sensors temperature output. In general, a steeper curve is preferred, meaning a shorter equilibrium time. This predetermines the sensor for more dynamic measurements as well as for slower changing temperature processes.

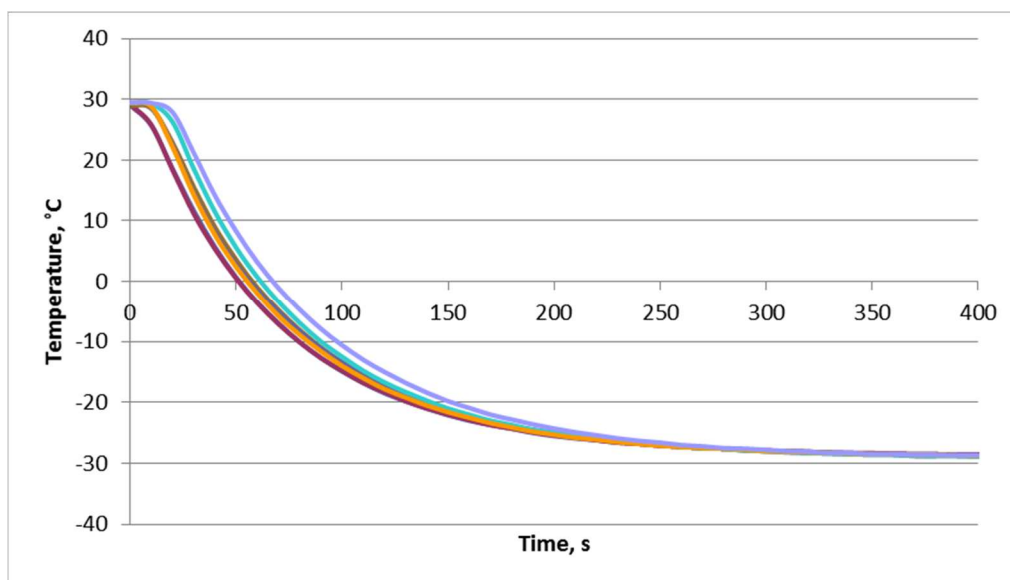

**Figure 13.** Repeated permafrost sensors (marked - M) reaction to a thermal shocks generated by a rapid temperature drop from 30 °C to -30 °C. According to the sampling frequency used by the involved datalogger, this curve can be used to include the sensors response time in the uncertainty budget

The measurements are still on-going and their results are intended to determine an uncertainty budget component into the permafrost measurements originating from this sensor property, in order to create a best practice document to help the end users to determine a specific permafrost sensor dynamic.

## 4 CONCLUSIONS AND PROSPECTS

### 4.1 CONCLUSIONS

Started as a Joint Research Project, MeteoMet has extended its activities and structure, towards an established and robust collaboration among its participants. The Consortium now groups more than 50 partners: National Metrology Institute, Universities, Manufacturers and private Companies, hydro-meteo Agencies, Research Institutes, Climatologists and International Institutions. Several signs of having made this collaboration effective can be found in the numerous experiments now running and delivering scientific results, as well as in the many events held and planned by the MeteoMet Community and even in the participation of MeteoMet staff in key world institutions.

This project, which aims were to develop metrological traceability for the measurement of main ECVs defined by GCOS and the evaluation of calibration uncertainties, is structured in three work packages each covering a different area of observation: Air, Sea and Land.

The MeteoMet consortium intends to extend the investigations to other variables and at evaluating further aspects and contributions to the uncertainty. The purpose is to make a further step towards the final goal: the evaluation of the overall measurements uncertainties for the quantities involved in the meteorological observations and climate change evaluations. The improvement of quality of ECVs recorded data through the inclusion of measurement uncertainty budget will bring to possible strategies for the reduction of the uncertainty.

### 4.2 IMPACT

Beyond the MeteoMet tasks, an immediate benefit was launched organising ILC with two loops using this protocol developed within the MeteoMet2 project. The ILC protocol and Final Report on intercomparison in the field of temperature, humidity and pressure MM-ILC-2015-THP was submitted to the WMO and published

1 as Instruments and Observing Methods WMO-IOM report. It is now planned that the ILC will be extended  
2 also to WMO regions RA II and RA Vin 2018. The results of all potential ILCs can be linked to the results in  
3 the European region (RA-VI) enabling comparability of meteorological laboratories from different regions.  
4

5 World leading manufacturers – such as Rotronic and Vaisala – will use the calibrations and tests performed  
6 within the framework of the MeteoMet project to improve their instruments. The GCOS Reference Upper-Air  
7 Network (GRUAN), WMO CIMO, WMO CCT<sup>c</sup>, and ISTI<sup>d</sup> were kept regularly updated on the project results  
8 by teleconferences. Hydro-meteorological agencies and local environmental services – such as, the  
9 MeteoSwiss (Payerne research site), UK MetOffice, ARSO (Slovenia), ARPA (Piemonte, Val d'Aosta - Italy),  
10 Società Meteorologica Italiana (Italy), and European Meteorological Society – were updated on the project  
11 results by dedicated meetings.  
12

13 The project International Conference on “Metrology for Meteorology and climate” (MMC), launched by  
14 MeteoMet in 2014 [30] is now recognized worldwide as a reference event in this interdisciplinary field. The  
15 MMC-2016 was held in conjunction with WMO CIMO Technical Conference (TECO) for a full week of  
16 presentations, satellite meetings and presence at the Meteorological Technology World Expo in Madrid. The  
17 MMC-2019 is already planned together with Tempmeko and Tempbeijing, in Beijing, China.  
18

19 The project results are moreover expected to contribute to the improvement of:  
20

- 21 ■ ISO 17714:2007 and CCT<sup>c</sup> Task Group for Guides on Thermometry (CCT-TG-GoTh) and Working  
22 Group for Humidity (WG-Hu);
- 23 ■ ISO/TS 17892-1:2004 and ISO 11271:2002 on Soil moisture;
- 24 ■ CIMO guide 8 revision;
- 25 ■ European Earth Observation Programme “Copernicus”<sup>f</sup>;
- 26 ■ PermaNET network<sup>g</sup>.

### 30 4.3 FURTHER WORK

31 Among the numerous activities, some key studies and researches are planned to be continued by NMIs in  
32 collaboration with the key stakeholders, also beyond the official lifetime of the JRP. In particular, the studies  
33 on the full evaluation of field measurement uncertainties will be continued for cryosphere observations and  
34 extreme environmental conditions, such as high Alps and the Arctic. Measurements of ECVs in the Arctic are  
35 performed under numerous research initiatives, stations and groups, generating an increasing amount of data,  
36 recorded by a multitude of instruments and installations. For example, cryosphere systems like permafrost are  
37 very sensitive to the exchange of energy between soil and atmosphere. Homogenised and traceable procedures  
38 of measurement are desirable and needed in order to produce comparable data. The evaluation of field  
39 measurement uncertainties is also a challenging aspect, and standard calibration procedures, available from  
40 calibration services, do not fully represent real measurement conditions. In the 2015 Arctic Circle Assembly  
41 and the 2015 NySMAC<sup>h</sup> meeting, the contribution from the metrology community in addressing such issues  
42 was identified to be of urgent importance, and an action towards the creation of a metrological infrastructure  
43 was included as a priority in the Flagship Programme on Atmospheric Research.  
44

45 The proposed research extends the underpinning metrology developed during the MeteoMet EMRP projects,  
46 which included an “Arctic Metrology Campaign”, performed in 2014 in Ny-Ålesund [14]. The benefit of  
47 having calibration devices available on site was acknowledged by the research community in Ny-Ålesund,  
48 with the proposal of starting a collaboration towards the realisation of a permanent calibration laboratory on  
49

---

50 <sup>c</sup>Commission for Climatology

51 <sup>d</sup>International Surface Temperature Initiative

52 <sup>e</sup>Comité Consultatif de Thermométrie (Consultative Committee for Thermometry)

53 <sup>f</sup><http://www.copernicus.eu/>

54 <sup>g</sup><http://www.permanet-alpinespace.eu/home.html>

55 <sup>h</sup>Ny-Ålesund Science Managers Committee (NySMAC) was established to enhance cooperation and coordination among  
56 researchers and research activities in Ny-Ålesund – Svalbard.  
57  
58  
59  
60

1 Svalbard [31]. Beside the arctic initiatives, the activities related to supporting Global Cryosphere Watch WMO  
2 programme also include the implementation of an Alpine open-air laboratory, for testing, comparing and  
3 evaluating instrumental performances and for adopting metrology techniques to evaluate field measurement  
4 uncertainties under the harsh environmental conditions experienced across the three key climate regions. One  
5 of the goal is the study and definition of standard installations for the evaluation of glaciers mass balance.  
6

7 Land ground-based stations continue to play a key role in the measurement of ECVs for the generation of data  
8 series, to detect long-term climate evolution. To reach full reliability and comparability in different places and  
9 different times, measured records need documented traceability to the SI and uncertainty evaluations. These  
10 metrological aspects are fundamental when measurement sites and stations are designed to provide reference-  
11 grade data. The MeteoMet consortium intends to promote the definition and features of reference-grade  
12 ground-based observing stations, also by comparing existing solutions, in terms of instruments capabilities,  
13 procedure to establish full documented traceability and target uncertainty. This activity will be in line with the  
14 planned creation of a Global Surface Reference Network by GCOS.  
15

16 The philosophy behind the definition of the metrological requirements for a reference-level surface observing  
17 system could also be used for other purposes, and for other networks, such as the stations recognized by the  
18 WMO Global Cryosphere Watch programme or those in urban areas, or for agricultural applications.. When  
19 top-level requirements are defined, downgrading the specification to baseline networks can lead to a better  
20 classification of sites, thus improving the current siting classifications under a cost-efficient approach.  
21

22 Key improvements of this proposal with respect to the state-of-the-art can be summarized as it follows:  
23

- 24 • a unique definition of reference-grade climate records, in terms of target measurement uncertainty,  
25 measurement method and instrument characteristics, and documented traceability to SI;
- 26 • highest quality installations, as reference observing stations in distributed networks;
- 27 • improvement in site classification and sustained performances classification guides;
- 28 • a contribution in the renewal process for historical and centennial stations;
- 29 • a preliminary contribution for the definition of reference urban and agricultural stations;
- 30 • a contribution in future actions, towards the creation of a European global climate reference network.  
31

32 At the time of the submission of this article, the mentioned actions are being considered, to establish continuity  
33 in this fruitful collaboration between the metrology and meteorology/climatology communities. The creation  
34 of Joint Research Units and Joint Research Laboratories is also being discussed within MeteoMet partners.  
35 Such distributed centres aim at becoming references for delivering high-quality research and services for  
36 potential stakeholders needing to deliver more robust data. Such joint initiative are being drafted by project  
37 partner and collaborators, to create consortia where all participating partners can contribute in developing  
38 specific areas of metrology to support those needs and deliver calibration services and dedicated procedures.  
39 This process will also try to avoid duplication and make well-identified distributed centres as references for  
40 data quality to be promoted within the EURAMET creation of European Metrology Networks.  
41

42 The general vision of this project and the associated initiatives is to establish permanent liaisons between the  
43 involved communities, for better environmental and climate knowledge and benefit to the present and future  
44 generations of operators and scientists. It will also imply the possibility of performing stronger validation and  
45 realistic quantification of the climate models, climate change and climate predictions in a global view, as well  
46 as their use for other scientific studies related to the understanding of Earth's evolution and most importantly  
47 contributing to Earth's survival.  
48

#### 49 **4.4 ACKNOWLEDGMENTS**

50 This work is being developed within the frame of the European Metrology Research Program (EMRP) joint  
51 research project ENV07 and ENV58 "METEOMET". The EMRP is jointly funded by the EMRP participating  
52 countries within EURAMET and the European Union.  
53  
54  
55  
56  
57  
58  
59  
60

## 5 REFERENCES

- [1] GCOS-184, GTOS-76, WMO-TD/No. 1523 2010 Update. Implementation plan for the Global Observing System for Climate in Support of the UNFCCC World Meteorological Organization, 2010 <http://www.wmo.int/pages/prog/gcos/Publications/gcos-138.pdf>
- [2] Merlone A, Lopardo G, Antonsen I, *et al* 2012, A new challenge for meteorological measurements: The “MeteoMet” project - Metrology for meteorology, *AIP Conf. Proc.* **1552** 1030-1035; Temperature: its measurement and control in science and industry, volume 8: Proceedings of the Ninth International Temperature Symposium, Date: 19–23 March 2012, Los Angeles, California DOI: 10.1063/1.4821419
- [3] Merlone A, Lopardo G, Sanna F, *et al*, 2015 The MeteoMet project – metrology for meteorology: challenges and results, *Meteorol. Appl.* **22** 820-829 DOI: 10.1002/met.1528
- [4] Sairanen H, Heinonen M and Höglström R, 2015. Validation of a calibration set-up for radiosondes to fulfil GRUAN requirements, *Meas. Sci. Technol.* **26** 105901
- [5] Underwood R, Gardiner T, Finlayson A, Bell S and de Podesta M. 2017. An improved non-contact thermometer and hygrometer with rapid response. *Metrologia* **54**(1) S9-S15
- [6] Guide to Meteorological Instruments and Methods of Observation, WMO-No. 8, 2008 edition, update 2010 [https://library.wmo.int/pmb\\_ged/wmo\\_8\\_en-2012.pdf](https://library.wmo.int/pmb_ged/wmo_8_en-2012.pdf)
- [7] Lopardo G, Bertiglia F, Curci S, Roggero G and Merlone A 2014, Comparative analysis of the influence of solar radiation screen ageing on temperature measurements by means of weather stations, *Int. J. Climatol.* **34**(4) 1297–1310, DOI: 10.1002/joc.3765
- [8] Bojkovski J, Hudoklin D, Groselj D, Drnovšek J, Begeš G. 2016. How to prepare ILC - case study meteorological laboratories. V: Begeš G, *et al*. Book of abstracts: MMC 2016, International Conference on Metrology for Meteorology and Climate in conjunction with WMO TECO 2016 Conference & Meteorological Technology World Expo 2016, September 26-29, Madrid, Spain, pp. 32
- [9] Groselj D, Bojkovski J, Begeš G. 2016. Concept of Interlaboratory Comparison in RAVI. V: WMO TECO 2016, 27-30 September 2016, Madrid, World Meteorological Organization, pp. 1-6
- [10] International Organization for Standardization, 2010, ISO/IEC 17043 - Conformity assessment -- *General requirements for proficiency testing*, April 2010
- [11] Lopardo G, Bellagarda S, Bertiglia F, Merlone A, Roggero G and N Jandric 2015, A calibration facility for automatic weather stations, *Meteorol. Appl.* **22** 842-846, DOI: 10.1002/met.1528
- [12] Vuillermoz E, Verza G, Cristofanelli P, Bonasoni P, Roggero G and Merlone A 2014 QA/QC Procedures for in-Situ Calibration of a High Altitude Automatic Weather Station: The Case Study of the AWS Pyramid, 5050 m a.s.l., Khumbu Valley, Nepal. *Atmospheric and Climate Sciences* **4** 796-802. DOI: 10.4236/acs.2014.45070
- [13] Merlone A, Roggero G and Verza G P 2015 In situ calibration of meteorological sensor in Himalayan high mountain environment, *Meteorol. Appl.* **22** 847-853, DOI: 10.1002/met.1528
- [14] Musacchio C, Bellagarda S, Maturilli M, Graeser J, Vitale V, Merlone A 2015, Arctic Metrology: calibration of radiosondes ground check sensors in Ny-Ålesund, *Meteorol. Appl.* **22** 854-860, DOI: 10.1002/met.1528
- [15] Thorne PW, Menne, MJ, Williams CN *et al.*, 2016 Reassessing changes in diurnal temperature range: A new data set and characterization of data biases. *J. Geophys. Res. Atmos.* **121** 5115-37 DOI: 10.1002/2015JD024583
- [16] Bertiglia F, Lopardo G, Merlone A, Roggero G, Cat Berro D, Mercalli L, Gilabert A, Brunet M 2015. Traceability of Ground-Based Air-Temperature Measurements: A Case Study on the Meteorological Observatory of Moncalieri (Italy), *Int. J. Thermophys* **36**(2-3) 589-601, DOI: 10.1007/s10765-014-1806-y
- [17] Sanna F, Cossu Q A, Roggero G, Bellagarda S and Merlone A. 2014 Evaluation of EPI forecasting model for grapevine infection with inclusion of uncertainty in input value and traceable calibration *Ital J Agrometeorol.* **19**(3) 33-44, DOI: 10.13140/2.1.2524.0644
- [18] Sanna F, Calvo A, Deboli R, Merlone A. Vineyard diseases detection: a case study on the influence of weather instruments calibration and positioning. *Meteorol. Appl.* **25**(1) DOI: 10.1002/met.1685
- [19] Santana MAA, Guimarães PLO, Lanza LG and Vuerich E 2015. Metrological analysis of a gravimetric calibration system for tipping-bucket rain gauges. *Meteorol. Appl.* **22** 879-885
- [20] GCOS, 2013: The GCOS Reference Upper-Air Network (GRUAN) GUIDE Technical Report no. 2013-03, GCOS-171, version 1.1.0.3 pp. 122

- 1 [21] Lakka A, Sairanen H, Heinonen M and Högström R, 2015. Comsol-simulations as a tool in validating a measurement  
2 chamber, *Int J Thermophys.* **36** 3474–3486 DOI: 10.1007/s10765-015-2000-6  
3
- 4 [22] Sairanen H, Heinonen M, Högström R, Lakka A and Kajastie H, 2014: A Calibration System for Reference  
5 Radiosondes that Meets GRUAN Requirements. *NCSLI Measure J. Meas. Sci.* **9** 56-60.  
6
- 7 [23] Pavlasek P, Merlone A, Musacchio C, Olsen AAF, Bergerud RA and Knazovicka L, 2016 Effect of changes in  
8 temperature scales on historical temperature data, *Int. J. Climatol.* **36(2)** 1005-1010, DOI: 10.1002/joc.4404  
9
- 10 [24] Garcia Benadí A, del Río Fernandez J, Nogueras Cervera M, Garcia Izquierdo C, del Campo D and Hernández S,  
11 2016 Optical fibers to measure temperature vertical profile at sea. A: 7<sup>th</sup> International Workshop on Marine  
12 Technology: Martech. "Instrumentation viewpoint". Vilanova i la Geltrú: SARTI, 2016 ISSN 1886-4864, DL-B  
13 32814-2006, p. 34  
14
- 15 [25] C. García Izquierdo, A. Garcia-Benadí, P. Corredera, D. del Campo, S. Hernandez, J. del Río Fernandez, M.  
16 Nogueras-Cervera, C. Pulido de Torres. 2017 Traceable Sea Temperature measurements performed by Optical fibers.  
17 *IMEKO International Conference on Metrology for The Sea (submitted)*  
18
- 19 [26] García Izquierdo C, del Campo D, Hernandez S, Gonzalez A, Garcia-Benadí A, del-Río-Fernández J, Nogueras-  
20 Cervera M. 2016. Calibration Uncertainties of CTDs in a large volume calibration bath. C. García Izquierdo, et al.  
21 Book of abstracts: *MMC 2016*, International Conference on Metrology for Meteorology and Climate in conjunction  
22 with WMO TECO 2016 Conference, September 26-29, Madrid, Spain, pp. 41  
23
- 24 [27] C. García Izquierdo, L. Šindelářová, S. Hernández, A. González, R. Strnad. Evaluation of the environment and the  
25 radiation shield influence on the self-heating effect of meteorological temperature sensors. C. García Izquierdo, et al.  
26 Book of abstracts: *MMC 2016*, International Conference on Metrology for Meteorology and Climate in conjunction  
27 with WMO TECO 2016 Conference, September 26-29, Madrid, Spain, pp. 4  
28
- 29 [28] C. García Izquierdo, S. Hernández, A. González, L. Matias, L. Šindelářová R. Strnad, D. del Campo. 2017 Evaluation  
30 of the Self-heating effect of several resistance thermometers used in meteorological and climate applications  
31 (*submitted*).  
32
- 33 [29] C. García Izquierdo, D. del Campo, S. Hernandez, A. González. Evaluation of the Hysteresis effect of some  
34 meteorological thermometers. C. García Izquierdo, *et al.* Book of abstracts: *MMC 2016*, International Conference on  
35 Metrology for Meteorology and Climate in conjunction with WMO TECO 2016 Conference, September 26-29,  
36 Madrid, Spain, pp. 40.  
37
- 38 [30] Merlone A, Musacchio C and Sanna F 2015. The Metrology for Meteorology Conference: MMC 2014, *Meteorol.*  
39 *Appl.* **22** 817-819, DOI: 10.1002/met.1548  
40
- 41 [31] Musacchio C, Merlone A, Viola A, Vitale V and Maturilli M 2016. Towards a calibration laboratory in Ny-Ålesund,  
42 *Rend. Fis. Acc. Lincei* **27(1)** 243-49 DOI 10.1007/s12210-016-0531-9  
43  
44  
45  
46  
47  
48  
49  
50  
51  
52  
53  
54  
55  
56  
57  
58  
59  
60

**Annex 1.** MeteoMet summary data, partners and collaborators**Table 1.** MeteoMet summary data

JRP start date and duration:	1 October 2011, 36 + 36 months
Budget:	> 11 M€
Number of planned deliverables	350
Total person month equivalent (including grants)	Approx. 1000
JRP-Coordinator:	Dr Andrea Merlone, INRiM
JRP website address	<a href="http://www.meteomet.org">http://www.meteomet.org</a>

**Table 2.** MeteoMet Partners and Granted Institutions

Acronyms	Name	Nationality
<b>Funded Partners</b>		
INRiM	Istituto Nazionale di Ricerca Metrologica (acting as JRP-Coordinator for the JRP-Consortium)	Italy
BEV/PTP	Physikalisch-Technischer Pruefdienst des Bundesamt fuer Eich- und Vermessungswesen	Austria
CEM	Centro Espanol de Metrologia	Spain
CETIAT	Centre Technique des Industries Aerauliques et Thermiques	France
CMI	Cesky Metrologicky Institut Brno	Czech Republic
CNAM	Conservatoire National des Arts et Metiers	France
CSIC	Agencia Estatal Consejo Superior de Investigaciones Cientificas	Spain
DTI	Teknologisk Institut Denmark	Denmark
GUM/MG	Ministerstwo Gospodarki	Poland
IMBiH	Institut za mjeriteljstvo Bosne i Hercegovine	Bosnia and Herzegovina
INTA	Instituto Nacional de Tecnica Aeroespacial	Spain
SMU	Institut Niskich Temperatur i Badan Strukturalnych	Poland
JV	Justervesenet	Norway
MIKES/VTT	Mittatekniikan Keskus/ Teknologian tutkimuskeskus	Finland
NPL	National Physical Laboratory	United Kingdom
PTB	Physikalisch-Technische Bundesanstalt	Germany
SMD	Federale Overheidsdienst Economie, KMO, Middenstand en Energie	Belgium
SMU,	Slovensky Metrologicky Ustav	Slovakia
SP	SP Sveriges Tekniska Forskningsinstitut AB	Sweden
TUBITAK/UME	Türkiye Bilimsel ve Teknolojik Araştırma Kurumu/Ulusal Metroloji Enstitüsü	Turkey
UL	Univerza v Ljubljani	Slovenia
VSL	Van Swinden Laboratorium B.V.	Netherlands
<b>Unfunded Partners</b>		
Chalmers	Chalmers tekniska hoegskola AB	Sweden



SHOM	Service hydrographique et océanographique de la Marine	France
UWr	Uniwersytet Wrocławski	Poland
Research Excellent Grant/ Research Mobility Grant		
REG(AU)	Aahrus Universitet,	Denmark
REG(C3)	Universitat Rovira i Virgili, Centre for Climate Change	Spain
REG(EV-K2 CNR)	EV-K2 Consiglio Nazionale delle Ricerche	Italy
REG(IMAMOTER-CNR)	Istituto per le Machine Agricole e MOVimento TERra – Consiglio Nazionale delle Ricerche	Italy
REG(KIT)	Karlsruhe Institut für Technologie	Germany
REG(UniGe)	Università degli Studi di Genova	Italy
REG(UniNa2)	Seconda Università degli Studi di Napoli	Italy
REG(UPC)	Universitat Politècnica de Catalunya	Spain
RMG(FSB)	Fakultet Strojarstva I Brodogradnje	Croatia
RMG(INBiH)	Institut za mjeriteljstvo Bosne i Hercegovine	Bosnia and Herzegovina
RMG(INTiBS)	Institut Niskich Temperatur i Badan Strukturalnych	Poland
RMG(MBM)	Montenegrin Bureau of Metrology	Montenegro
RMG(SMU)	Slovensky Metrologicky Ustav	Slovakia

In different ways, along the lifetime of the project, since 2011, are or have been involved as collaborators in MeteoMet:

Private companies:

3a Srl, Bodeker-Scientific, CAE, Cal Power, Climate Consulting S.r.l., Grafinta Sociedad Anonima, Lombard & Marozzini, Lufft, Meteomodem, Michell Italia S.r.l., Rotronic, TRUEBNER Instruments, Vaisala Oyj, NKE Instrumentations.

Hydro-meteorological and environmental agencies and Organizations:

Agencia Estatal de Meteorologia (AEMET), Alfred-Wegener-Institut (AWI), Agenzia Regionale per la Prevenzione e l'Ambiente(ARPA) Lombardia; Piemonte; Sardegna; Valle d'Aosta, NOAA's National Climatic Data Center, Czech Hydrometeorological Institute, Danish Meteorological Institute - Department of Geosciences, DHI-Water Environment, Environmental Agency of the republic of Slovenia (ARSO), Federal Civil Aviation Department - Federal Hydrometeorological Institute of Bosnia and Herzegovina (FHMZ), Finnish Meteorological Institute (FMI), Japan Meteorological Agency (JMA), Met. Office Research Unit, Meteo Swiss, Météo France National, Royal Meteorological Institute of Belgium, Royal Netherlands Institute for Sea Research (NIOZ), Royal Netherlands Meteorological Institute (KNMI), Scientific Committee on Oceanic Research (SCOR), Sistemas de Monitorización Medio Ambiental, S.L.U., Società Meteorologica Italiana (SMI), Swedish Meteorological and Hydrological Institute (SMHI), Turkish State Meteorological Service (TSMS), World Meteorological Organization (WMO).

Research Institutes, networks and Initiatives:

Cooperative Institute for Climate and Satellites – NC, Extreme Energy Events Project Centro Studi e Ricerche “E. Fermi”, GCOS Reference Upper Air Network, Hochschule Bonn-Rhein-Sieg - Internationales Zentrum für Nachhaltige Entwicklung - Institut für Umweltphysik, Instituto Nacional de Tecnología Industrial, International Association for the Physical Sciences of the Ocean (IAPSO), International Association for the Properties of Water and Steam (IAPWS), International Surface Temperatures Initiative, Consiglio Nazionale delle Ricerche (Istituto di Ricerca per la Protezione Idrogeologica – IRPI; Istituto di Scienze dell'Atmosfera e del Clima – ISAC; Istituto per le Macchine Agricole e Movimento Terra – IMAMOTER, Istituto di Metodologie per l'Analisi Ambientale – IMAA), Istituto Superiore per la Protezione e la Ricerca Ambientale

1 (ISPRA), Joint Committee on the Properties of Seawater, Laboratorio de Calibración de Sensores  
2 Meteorológicos - Osservatorio Meteo Duomo  
3  
4 Universities:  
5 Laboratoire de Météorologie Dynamique - Ecole Polytechnique Lyon, Tallinn University of Technology,  
6 University of Fribourg, University of Reading - Department of Meteorology, Uni-Ruse-Bulgaria - Physics  
7 Department./ National Institute of Meteorology and Hydrology, Università Cattolica Piacenza, Università degli  
8 studi di Cassino, Università di Milano, Università di Torino - Dipartimento di Scienze della Terra and  
9 Dipartimento di Fisica, Università di Trento - Department of Civil, Environmental and Mechanical  
10 Engineering - Atmospheric Physics Group, Università IUAV di Venezia - Laboratorio di Fisica Tecnica e  
11 Ambientale, University of Leicester, National Centre for Earth Observation Space Research Centre -University  
12 of Miami, Group for High Resolution Sea Surface Temperature, Universidad del País Vasco, University of  
13 Ljubljana - Laboratory of Metrology and Quality, University of Wrocław - Department of Climatology and  
14 Atmosphere Protection.  
15  
16  
17  
18  
19  
20  
21  
22  
23  
24  
25  
26  
27  
28  
29  
30  
31  
32  
33  
34  
35  
36  
37  
38  
39  
40  
41  
42  
43  
44  
45  
46  
47  
48  
49  
50  
51  
52  
53  
54  
55  
56  
57  
58  
59  
60