

AperTO - Archivio Istituzionale Open Access dell'Università di Torino

Bivariate C^2 cubic spline quasi-interpolants on uniform Powell-Sabin triangulations of a rectangular domain

This is the author's manuscript

Original Citation:

Availability:

This version is available <http://hdl.handle.net/2318/108486> since 2016-01-28T10:16:09Z

Published version:

DOI:10.1007/s10444-011-9178-3

Terms of use:

Open Access

Anyone can freely access the full text of works made available as "Open Access". Works made available under a Creative Commons license can be used according to the terms and conditions of said license. Use of all other works requires consent of the right holder (author or publisher) if not exempted from copyright protection by the applicable law.

(Article begins on next page)



UNIVERSITÀ DEGLI STUDI DI TORINO

This is an author version of the contribution published on:

Sara Remogna. Bivariate C^2 cubic spline quasi-interpolants on uniform Powell-Sabin triangulations of a rectangular domain. *Advances in Computational Mathematics*, 36, no. 1, 2012, DOI 10.1007/s10444-011-9178-3.

The definitive version is available at:

<http://link.springer.com/article/10.1007%2Fs10444-011-9178-3>

Bivariate C^2 cubic spline quasi-interpolants on uniform Powell-Sabin triangulations of a rectangular domain

Sara Remogna

Received: date / Accepted: date

Abstract In this paper we construct discrete quasi-interpolants based on C^2 cubic multi-box splines on uniform Powell-Sabin triangulations of a rectangular domain. The main problem consists in finding the coefficient functionals associated with boundary multi-box splines (i.e. multi-box splines whose supports overlap with the domain) involving data points inside or on the boundary of the domain and giving the optimal approximation order.

They are obtained either by minimizing an upper bound for the infinity norm of the operator w.r.t. a finite number of free parameters, or by inducing the superconvergence of the gradient of the quasi-interpolant at some specific points of the domain.

Finally, we give norm and error estimates and we provide some numerical examples illustrating the approximation properties of the proposed operators.

Keywords Spline approximation · Quasi-interpolation operator · Multi-box spline

Mathematics Subject Classification (2000) 41A05 · 65D07

1 Introduction

Let $\Omega = [0, m_1 h] \times [0, m_2 h]$, $m_1, m_2 \geq 5$, be a rectangular domain divided into $m_1 m_2$ equal squares, each of them subdivided into two triangles by its main diagonal and then each of these two triangles subdivided into six subtriangles by its medians, obtaining the Powell-Sabin triangulation $\mathcal{T}_{m_1, m_2}^{PS}$ [18], see Fig. 1.

Let $S_3^2(\Omega, \mathcal{T}_{m_1, m_2}^{PS})$ be the space of C^2 cubic splines on $\mathcal{T}_{m_1, m_2}^{PS}$. According to [6], the dimension of this space is

$$\dim S_3^2(\Omega, \mathcal{T}_{m_1, m_2}^{PS}) = 2m_1 m_2 + 4(m_1 + m_2) + 6,$$

and it is spanned by dilation/translation of the vector $\varphi = [\varphi_1, \varphi_2]^T$ of multi-box splines (see [5, 14–16]). There are $(m_1 + 1)(m_2 + 1)$ shifts of φ_1 , denoted by $\varphi_{1, \alpha}$, $\alpha \in \mathcal{A}_1$, $\mathcal{A}_1 = \{(i, j), 0 \leq i \leq m_1, 0 \leq j \leq m_2\}$ and $(m_1 + 3)(m_2 + 3) - 2$ shifts of φ_2 ,

S. Remogna

Department of Mathematics, University of Torino, via C. Alberto, 10 – 10123 Torino, Italy
E-mail: sara.remogna@unito.it

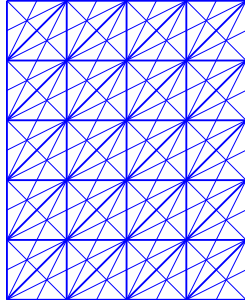

Fig. 1 The Powell-Sabin triangulation

denoted by $\varphi_{2,\alpha}$, $\alpha \in \mathcal{A}_2$, $\mathcal{A}_2 = \{(i, j), -1 \leq i \leq m_1 + 1, -1 \leq j \leq m_2 + 1; (i, j) \neq (m_1 + 1, -1), (-1, m_2 + 1)\}$ whose supports overlap with or are included in the domain, totaling to $2m_1m_2 + 4(m_1 + m_2) + 8 = \dim S_3^2(\Omega, \mathcal{T}_{m_1, m_2}^{PS}) + 2$. Therefore, the generators of $S_3^2(\Omega, \mathcal{T}_{m_1, m_2}^{PS})$ are linearly dependent, however, this fact is not important for quasi-interpolation.

Since φ_1 and φ_2 are centered at the origin (see Figs. 3 and 4) we define their scaled translates in the following way:

$$\begin{aligned}\varphi_{1,\alpha}(x, y) &= \varphi_{1,(i,j)}(x, y) = \varphi_1\left(\frac{x}{h} - i, \frac{y}{h} - j\right), \\ \varphi_{2,\alpha}(x, y) &= \varphi_{2,(i,j)}(x, y) = \varphi_2\left(\frac{x}{h} - i, \frac{y}{h} - j\right),\end{aligned}$$

whose supports are centered at the points $c_\alpha = c_{i,j} = (ih, jh)$.

In the space $S_3^2(\Omega, \mathcal{T}_{m_1, m_2}^{PS})$ we consider discrete quasi-interpolants (abbr. dQIs) of type

$$Qf = \sum_{\alpha \in \mathcal{A}_2} [\lambda_{1,\alpha}(f), \lambda_{2,\alpha}(f)] \bar{\varphi}_\alpha, \quad (1)$$

where, in order to satisfy the partition of unity in Ω , $\bar{\varphi} = [\bar{\varphi}_1, \bar{\varphi}_2]^T$ are the normalized multi-box splines

$$\bar{\varphi}_1 = \frac{1}{6}\varphi_1, \quad \bar{\varphi}_2 = \frac{1}{2}\varphi_2$$

with $\bar{\varphi}_{1,\alpha} \equiv 0$ for $\alpha \in \mathcal{A}_2 \setminus \mathcal{A}_1$. In Figs. 3 and 4 the supports and the graphs of $\bar{\varphi}_1$ and $\bar{\varphi}_2$ are shown.

The set $\{[\lambda_{1,\alpha}(f), \lambda_{2,\alpha}(f)], \alpha \in \mathcal{A}_2\}$ is a family of linear functionals which are local, in the sense that they are linear combinations of values of f at some points lying inside Ω and in the neighbourhood of the supports of $\bar{\varphi}_\alpha$. Moreover, they are constructed in order that Q is exact on the space $\mathbb{P}_3(\mathbb{R}^2)$ of bivariate polynomials of total degree at most three.

The data points used in the definition of $\lambda_{1,\alpha}(f)$, $\lambda_{2,\alpha}(f)$ are the vertices of each square, $A_\alpha = A_{k,l} = (kh, lh)$, with $\alpha \in \mathcal{A} = \{(k, l), k = 0, \dots, m_1, l = 0, \dots, m_2\}$, see Fig. 2, and f_α denotes the value of the function f at the point A_α , i.e. $f_\alpha = f(A_\alpha)$.

In [11], the authors proposed two kinds of differential and discrete quasi-interpolants on the whole plane \mathbb{R}^2 . If we use them on a bounded domain, the coefficient functionals associated with boundary multi-box splines (i.e. multi-box splines whose supports overlap with the domain) make use of data points outside Ω . Therefore, in order to obtain a discrete quasi-interpolant of the form (1) using data points inside or on the boundary of Ω , the aim of this paper is to define new coefficient functionals for boundary multi-box splines.

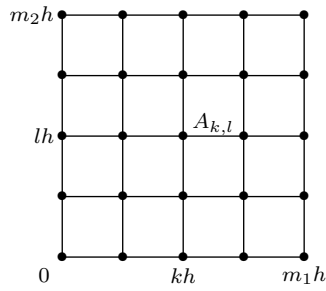

Fig. 2 Data points

Here is an outline of the paper. In Section 2 we recall the main results on multi-box spline generators and the differential and discrete quasi-interpolants defined on the whole plane and proposed in [11]. In Sections 3 and 4 we construct two different discrete quasi-interpolants on bounded domains: near-best dQIs, obtained by minimizing the infinity norm of each coefficient functional, and dQIs with superconvergence properties for the gradient. Finally, in Section 5 we give norm and error estimates and, in Section 6 we provide some numerical examples illustrating the approximation properties of the proposed dQIs.

2 C^2 cubic splines on uniform Powell-Sabin triangulations and quasi-interpolants on \mathbb{R}^2

The space of C^2 cubic splines on uniform Powell-Sabin triangulations of the plane \mathbb{R}^2 has been recently studied in [6,7], where it is shown that any element of this space can be expressed as linear combination of a pair of refinable generators $\varphi = [\varphi_1, \varphi_2]^T$. In [5] Chap.6, the author identifies φ_1, φ_2 as particular examples of multi-box splines, introduced in [16], on the six-directional mesh shown in Fig. 1 and defined by the direction vectors

$$\begin{aligned} e_1 &= (1, 0), & e_2 &= (0, 1), & e_3 &= (1, 1), \\ e_4 &= (-1, 1), & e_5 &= (2, 1), & e_6 &= (1, 2). \end{aligned}$$

The support of φ_1 is the unit hexagon with vertices $\{\pm e_1, \pm e_2, \pm e_3\}$, see Fig. 3(a), and φ_2 is defined as $\varphi_2 = \varphi_1(A_1^{-1})$, where

$$A_1 = \begin{bmatrix} 2 & -1 \\ 1 & -2 \end{bmatrix}.$$

Thus

$$\varphi_2(x_1, x_2) = \varphi_1 \left(\frac{1}{3}(2x_1 - x_2), \frac{1}{3}(x_1 - 2x_2) \right)$$

and the support of φ_2 is the hexagon with vertices $\{\pm e_4, \pm e_5, \pm e_6\}$, see Fig. 4(a).

The functions φ_1, φ_2 are defined by their Fourier transforms. Setting $\varphi = [\varphi_1, \varphi_2]^T$, $z_1 = e^{-iu_1}$, $z_2 = e^{-iu_2}$, the Fourier transform is equal to

$$\hat{\varphi}(u_1, u_2) = [\hat{\varphi}_1(u_1, u_2), \hat{\varphi}_2(u_1, u_2)]^T = \frac{[u_1, u_1 + u_2]R(z_1, z_2)}{u_1 u_2 (u_1 + u_2)(u_1 - u_2)(u_1 + 2u_2)(2u_1 + u_2)}$$

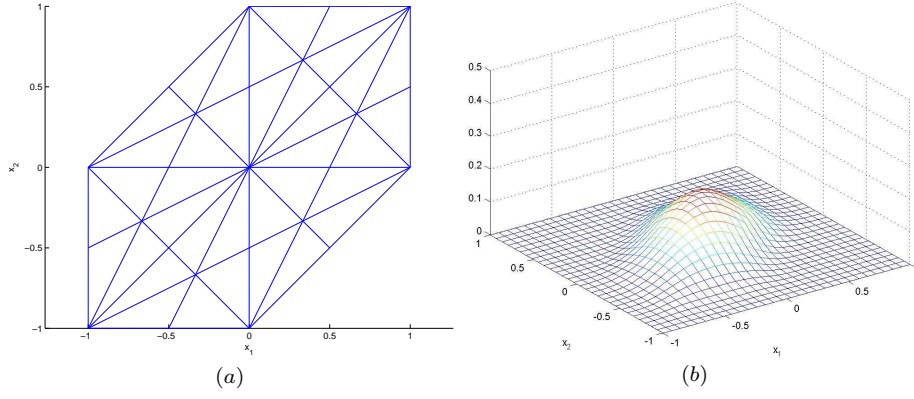

Fig. 3 The support (a) and the graph (b) of φ_1

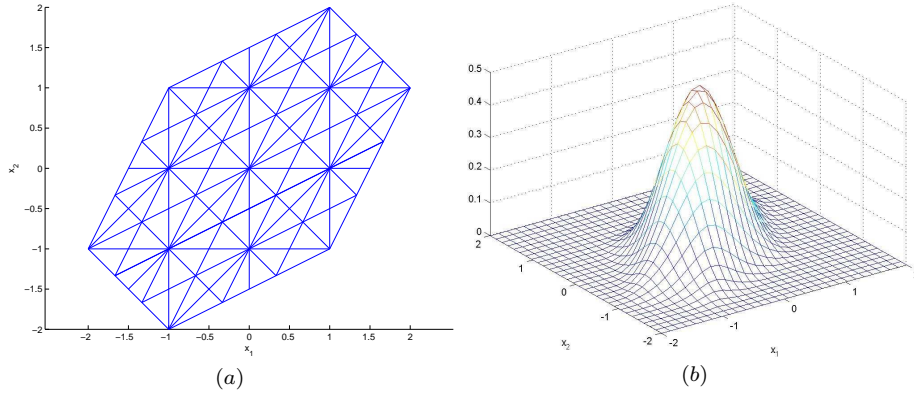

Fig. 4 The support (a) and the graph (b) of φ_2

where

$$R(z_1, z_2) = \begin{bmatrix} P_1(z_1, z_2) & P_2(z_1, z_2) \\ Q_1(z_1, z_2) & Q_2(z_1, z_2) \end{bmatrix},$$

whose elements are given by the following Laurent polynomials with real coefficients

$$\begin{aligned} P_1(z_1, z_2) &= z_1 + 2z_1z_2 + z_2 - z_1^{-1} - 2z_1^{-1}z_2^{-1} - z_2^{-1}, \\ P_2(z_1, z_2) &= -3z_1^2z_2 + 3z_1^{-1}z_2^{-2} + 3z_1^{-2}z_2^{-1} - 3z_1z_2^2, \\ Q_1(z_1, z_2) &= -2z_1 - z_1z_2 + z_2 + 2z_1^{-1} + z_1^{-1}z_2^{-1} - z_2^{-1}, \\ Q_2(z_1, z_2) &= 3z_1^2z_2 + 3z_1z_2^{-1} - 3z_1^{-2}z_2^{-1} - 3z_1^{-1}z_2. \end{aligned}$$

In [11] the authors propose two differential quasi-interpolants, exact on $\mathbb{P}_3(\mathbb{R}^2)$ of second and fourth order, respectively

$$\begin{aligned} \hat{Q}f &= \sum_{\alpha \in \mathbb{Z}^2} [\hat{\lambda}_{1,\alpha}(f), \hat{\lambda}_{2,\alpha}(f)] \varphi_\alpha, \\ \tilde{Q}f &= \sum_{\alpha \in \mathbb{Z}^2} [\tilde{\lambda}_{1,\alpha}(f), \tilde{\lambda}_{2,\alpha}(f)] \varphi_\alpha, \end{aligned} \quad (2)$$

where

$$\begin{aligned}\widehat{\lambda}_{1,\alpha}(f) &= f_\alpha + \frac{h^2}{6} \Delta^* f_\alpha, \\ \widehat{\lambda}_{2,\alpha}(f) &= f_\alpha - \frac{h^2}{6} \Delta^* f_\alpha, \\ \widetilde{\lambda}_{1,\alpha}(f) &= f_\alpha + \frac{h^2}{6} \Delta^* f_\alpha + \frac{h^4}{108} (\Delta^*)^2 f_\alpha, \\ \widetilde{\lambda}_{2,\alpha}(f) &= f_\alpha - \frac{h^2}{6} \Delta^* f_\alpha + \frac{h^4}{108} (\Delta^*)^2 f_\alpha,\end{aligned}$$

with $\Delta^* = \partial_1^2 + \partial_1 \partial_2 + \partial_2^2 = \frac{\partial^2}{\partial x_1^2} + \frac{\partial^2}{\partial x_1 \partial x_2} + \frac{\partial^2}{\partial x_2^2}$.

From these differential quasi-interpolants, two different discrete quasi-interpolants are constructed in [11]:

$$Q^* f = \sum_{\alpha \in \mathbb{Z}^2} [\lambda_{1,\alpha}^*(f), \lambda_{2,\alpha}^*(f)] \bar{\varphi}_\alpha, \quad (3)$$

$$Q^{**} f = \sum_{\alpha \in \mathbb{Z}^2} [\lambda_{1,\alpha}^{**}(f), \lambda_{2,\alpha}^{**}(f)] \bar{\varphi}_\alpha, \quad (4)$$

where

$$\lambda_{1,\alpha}^*(f) = \frac{1}{3} f_\alpha + \frac{1}{6} (f_{\alpha \pm e_1} + f_{\alpha \pm e_2}) + \frac{1}{24} (f_{\alpha \pm e_3} - f_{\alpha \pm e_4}), \quad (5)$$

$$\lambda_{2,\alpha}^*(f) = \frac{5}{3} f_\alpha - \frac{1}{6} (f_{\alpha \pm e_1} + f_{\alpha \pm e_2}) - \frac{1}{24} (f_{\alpha \pm e_3} - f_{\alpha \pm e_4}), \quad (6)$$

$$\begin{aligned}\lambda_{1,\alpha}^{**}(f) &= \frac{11}{24} f_\alpha + \frac{5}{54} (f_{\alpha \pm e_1} + f_{\alpha \pm e_2} + f_{\alpha \pm e_3}) \\ &\quad - \frac{1}{432} (f_{\alpha \pm 2e_1} + f_{\alpha \pm 2e_2} + f_{\alpha \pm 2e_3}),\end{aligned} \quad (7)$$

$$\begin{aligned}\lambda_{2,\alpha}^{**}(f) &= \frac{41}{24} f_\alpha - \frac{7}{54} (f_{\alpha \pm e_1} + f_{\alpha \pm e_2} + f_{\alpha \pm e_3}) \\ &\quad + \frac{5}{432} (f_{\alpha \pm 2e_1} + f_{\alpha \pm 2e_2} + f_{\alpha \pm 2e_3}),\end{aligned} \quad (8)$$

and with infinity norm bounded by

$$\|Q^*\|_\infty \leq \frac{5}{2} = 2.5, \quad \|Q^{**}\|_\infty \leq \frac{23}{9} \approx 2.56.$$

The discrete supports of functionals are shown in Fig. 5 and in Fig. 6.

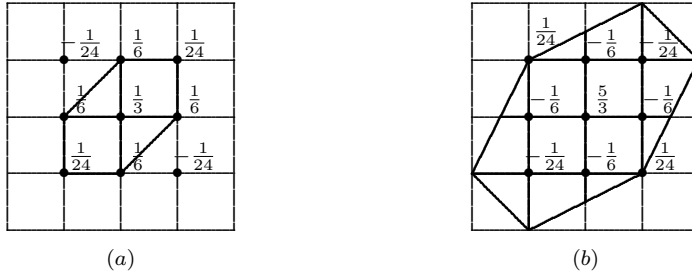

Fig. 5 Functionals associated with $\bar{\varphi}_1$ (a) and $\bar{\varphi}_2$ (b) in Q^*

These operators are exact on $\mathbb{P}_3(\mathbb{R}^2)$ and the approximation order is 4 for smooth functions, i.e. $f - Q^* f$ and $f - Q^{**} f$ are $O(h^4)$. Furthermore they satisfy the following superconvergence properties: the approximation order of the gradient is 4 and $\nabla(f - Q^* f)$, $\nabla(f - Q^{**} f)$ are $O(h^4)$ for smooth functions, at the following points (see Fig. 7):

- the vertices of squares $A_{k,l} = (kh, lh)$, $(k, l) \in \mathbb{Z}^2$,

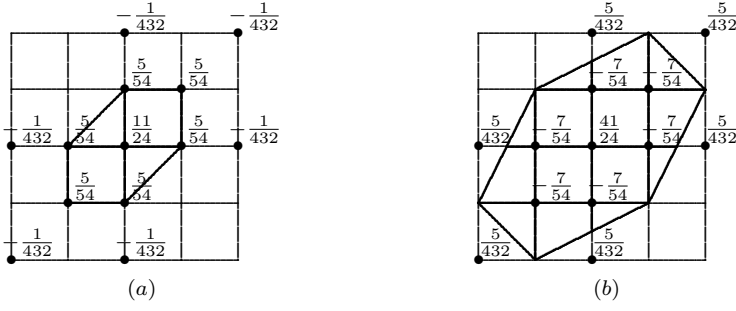

Fig. 6 Functionals associated with $\bar{\varphi}_1$ (a) and $\bar{\varphi}_2$ (b) in Q^{**}

- the centers of squares $M_{k,l} = ((k - \frac{1}{2})h, (l - \frac{1}{2})h)$, $(k, l) \in \mathbb{Z}^2$,
- the midpoints $C_{k,l} = ((k - \frac{1}{2})h, lh)$ of horizontal edges $A_{k-1,l}A_{k,l}$, $(k, l) \in \mathbb{Z}^2$,
- the midpoints $D_{k,l} = (kh, (l - \frac{1}{2})h)$ of vertical edges $A_{k,l-1}A_{k,l}$, $(k, l) \in \mathbb{Z}^2$.

Moreover $f - Q^{**}f$ is $O(h^6)$ at the points $A_{k,l}$.

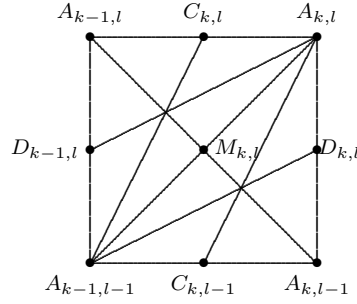

Fig. 7 Points of superconvergence

Using the method presented in [19], we are interested in the construction of two different types of discrete quasi-interpolants

$$\begin{aligned} Q_1 f &= \sum_{\alpha \in \mathcal{A}_2} [\mu_{1,\alpha}(f), \mu_{2,\alpha}(f)] \bar{\varphi}_\alpha, \\ Q_2 f &= \sum_{\alpha \in \mathcal{A}_2} [\lambda_{1,\alpha}(f), \lambda_{2,\alpha}(f)] \bar{\varphi}_\alpha, \end{aligned}$$

whose coefficients are linear functionals of the form

$$\begin{aligned} \mu_{v,\alpha}(f) &= \sum_{\beta \in F_{v,\alpha}} \sigma_{v,\alpha}(\beta) f(A_\beta), \quad v = 1, 2 \\ \lambda_{v,\alpha}(f) &= \sum_{\beta \in G_{v,\alpha}} \tau_{v,\alpha}(\beta) f(A_\beta), \quad v = 1, 2 \end{aligned} \tag{9}$$

where, for $v = 1, 2$, the finite sets of points $\{A_\beta, \beta \in F_{v,\alpha}\}$, $\{A_\beta, \beta \in G_{v,\alpha}\}$, $F_{v,\alpha}$, $G_{v,\alpha} \subset \mathcal{A}$ lie in some neighbourhood of $\text{supp } \bar{\varphi}_{v,\alpha} \cap \Omega$ and such that $Q_v f \equiv f$ for all f in $\mathbb{P}_3(\mathbb{R}^2)$.

The construction of such coefficient functionals is related to the differential quasi-interpolant exact on $\mathbb{P}_3(\mathbb{R}^2)$ and defined on the infinite plane, given by (2).

We propose two different ways of constructing functionals associated with the scaled multi-box splines whose supports are not entirely inside Ω : the first leads to functionals (denoted by $\mu_{v,\alpha}$) of near-best type, and the second leads to functionals (denoted by $\lambda_{v,\alpha}$) inducing superconvergence of the gradient at some specific points of the domain.

In the interior of the domain, for $i = 1, \dots, m_1 - 1$, $j = 1, \dots, m_2 - 1$, our quasi-interpolants make use of the same inner functionals defined by (5) and (6).

We have not proposed quasi-interpolants with inner functionals of type (7) and (8), instead of (5) and (6), because, in this case, we would have to construct a greater number of functionals. Indeed, only for $i = 2, \dots, m_1 - 2$, $j = 2, \dots, m_2 - 2$ the data points involved in (7) and (8) lie inside or on the boundary of the domain, therefore, for $i = 1, m_1 - 1$, $j = 1, \dots, m_2 - 1$ and $i = 2, \dots, m_1 - 2$, $j = 1, m_2 - 1$, we would have to consider other coefficient functionals.

3 Construction of near-best boundary functionals

In this section we construct convenient boundary coefficient functionals, called near-best functionals, giving the optimal approximation order as in the case of the whole space \mathbb{R}^2 (see Section 2).

In the definition of functionals, we consider more data points than the number of conditions we are imposing, thus we obtain a system of equations with free parameters and we choose them by minimizing an upper bound for the infinity norm of the operator.

The method used in this subsection is closely related to the techniques given in [1–3, 17] to define near-best discrete quasi-interpolants on type-1 and type-2 triangulations (see also [4, 19, 21]).

From (9) it is clear that, for $\|f\|_\infty \leq 1$ and $\alpha \in \mathcal{A}_2$, $|\mu_{v,\alpha}(f)| \leq \|\sigma_{v,\alpha}\|_1$, where $\sigma_{v,\alpha}$ is the vector with components $\sigma_{v,\alpha}(\beta)$. Therefore, since the sum of scaled translates of $\bar{\varphi}_1$ and $\bar{\varphi}_2$ is equal to one, we deduce immediately

$$\|Q_1\|_\infty \leq \max_{v=1,2} \max_{\alpha \in \mathcal{A}_2} |\mu_{v,\alpha}(f)| \leq \max_{v=1,2} \max_{\alpha \in \mathcal{A}_2} \|\sigma_{v,\alpha}\|_1. \quad (10)$$

Now we can try to find a solution $\sigma_{v,\alpha}^* \in \mathbb{R}^{\text{card}(F_{v,\alpha})}$ of the minimization problem (see e.g. [3], [17] Chap.3)

$$\|\sigma_{v,\alpha}^*\|_1 = \min \left\{ \|\sigma_{v,\alpha}\|_1; \sigma_{v,\alpha} \in \mathbb{R}^{\text{card}(F_{v,\alpha})}, V_{v,\alpha} \sigma_{v,\alpha} = b_{v,\alpha} \right\}, \quad v = 1, 2$$

where $V_{v,\alpha} \sigma_{v,\alpha} = b_{v,\alpha}$ is a linear system expressing that Q_1 is exact on $\mathbb{P}_3(\mathbb{R}^2)$. In our case we require that the coefficient functionals coincide with the differential ones for $f \in \mathbb{P}_3(\mathbb{R}^2)$.

This problem is a l_1 -minimization problem and there are many well-known techniques for approximating the solutions, not unique in general (cf. [23] Chap.6). Since the minimization problem is equivalent to a linear programming one, here we use the simplex method.

Before giving the explicit expressions of each coefficient functional, we propose a general method to find a ‘good direction’ for minimizing the infinity norm. The exactness of Q_1 on $\mathbb{P}_3(\mathbb{R}^2)$ gives ten conditions (or six in case of symmetry of the support w.r.t. the line $y = x$). Thus we start with a scheme for the coefficient functionals

containing ten (or six) unknown parameters. Therefore the resulting linear system has an equal number of equations and unknowns.

In order to reduce the infinity norm, we consider a new functional scheme obtained from the preceding one by adding a new parameter. We consider several schemes and in each of them the new parameter is associated with different data points. We compute the infinity norm of each new functional and we select as new scheme the one having the smallest norm.

We explain this method in detail in the cases $\mu_{1,(0,0)}$ and $\mu_{2,(-1,-1)}$. For the other cases we follow the same logical scheme (see [20] for detail).

3.1 Example 1: the functional $\mu_{1,(0,0)}$

We consider the 9-point linear functional, defined using 6 unknowns

$$\begin{aligned} \mu_{1,(0,0)}(f) = & a_1 f_{0,0} + a_2(f_{1,0} + f_{0,1}) + a_3(f_{2,0} + f_{0,2}) + a_4 f_{1,1} \\ & + a_5(f_{3,0} + f_{0,3}) + a_6 f_{2,2}, \end{aligned}$$

and we impose $\mu_{1,(0,0)}(f) \equiv (f + \frac{h^2}{6} \Delta^* f)(c_{0,0})$, $c_{0,0} = (0, 0)$, for $f \equiv 1, x, x^2, xy, x^3, x^2y$. Due to the symmetry of the support of $\varphi_{1,(0,0)}$ w.r.t. the line $y = x$, we have only 6 conditions to impose (the monomials y, y^2, xy^2 and y^3 can be excluded). This leads to the system:

$$\begin{aligned} a_1 + 2a_2 + 2a_3 + a_4 + 2a_5 + a_6 &= 1, & a_2 + 2a_3 + a_4 + 3a_5 + 2a_6 &= 0, \\ a_2 + 4a_3 + a_4 + 9a_5 + 4a_6 &= 1/3, & a_4 + 4a_6 &= 1/6, \\ a_2 + 8a_3 + a_4 + 27a_5 + 8a_6 &= 0, & a_4 + 8a_6 &= 0, \end{aligned}$$

whose unique solution is

$$a_1 = \frac{47}{24}, \quad a_2 = -\frac{7}{6}, \quad a_3 = \frac{17}{24}, \quad a_4 = \frac{1}{3}, \quad a_5 = -\frac{1}{6}, \quad a_6 = -\frac{1}{24},$$

with a norm $\|\mu_{1,(0,0)}\|_\infty \approx 6.42$.

If we want a functional with a smaller norm, we can add a parameter: a_7 . For example we consider the following coefficients

$$\mu'_{1,(0,0)}(f) = \mu_{1,(0,0)}(f) + a_7(f_{2,1} + f_{1,2}), \quad (11)$$

$$\mu'_{1,(0,0)}(f) = \mu_{1,(0,0)}(f) + a_7(f_{4,0} + f_{0,4}), \quad (12)$$

$$\mu'_{1,(0,0)}(f) = \mu_{1,(0,0)}(f) + a_7 f_{3,3}. \quad (13)$$

In each example the parameter a_7 is associated with different data points.

Solving the corresponding systems and minimizing the norm $\|\mu'_{1,(0,0)}\|_\infty$, we obtain the values

$$\text{case (11): } \|\mu'_{1,(0,0)}\|_\infty \approx 5.92,$$

$$\text{case (12): } \|\mu'_{1,(0,0)}\|_\infty \approx 4.33,$$

$$\text{case (13): } \|\mu'_{1,(0,0)}\|_\infty \approx 3.07.$$

Therefore we choose the functional proposed in (13), where

$$a_1 = \frac{269}{216}, \quad a_2 = 0, \quad a_3 = \frac{1}{8}, \quad a_4 = -\frac{5}{6}, \quad a_5 = -\frac{1}{27}, \quad a_6 = \frac{13}{24}, \quad a_7 = -\frac{7}{54},$$

and with discrete support shown in Fig. 8(a).

3.2 Example 2: the functional $\mu_{2,(-1,-1)}$

We consider the 9-point linear functional, defined using 6 unknowns

$$\begin{aligned} \mu_{2,(-1,-1)}(f) = & a_1 f_{0,0} + a_2(f_{1,0} + f_{0,1}) + a_3(f_{2,0} + f_{0,2}) + a_4 f_{1,1} \\ & + a_5(f_{3,0} + f_{0,3}) + a_6 f_{2,2}, \end{aligned}$$

and we impose $\mu_{2,(-1,-1)}(f) \equiv (f - \frac{h^2}{6} \Delta^* f)(c_{-1,-1})$, $c_{-1,-1} = (-h, -h)$, for $f \equiv 1, x, x^2, xy, x^3, x^2y$. Due to the symmetry of the support of $\varphi_{2,(-1,-1)}$ w.r.t. the line $y = x$, we have only 6 conditions to impose (the monomials y, y^2, xy^2 and y^3 can be excluded). This leads to the system:

$$\begin{aligned} a_1 + 2a_2 + 2a_3 + a_4 + 2a_5 + a_6 &= 1, & a_2 + 2a_3 + a_4 + 3a_5 + 2a_6 &= -1, \\ a_2 + 4a_3 + a_4 + 9a_5 + 4a_6 &= 2/3, & a_4 + 4a_6 &= 5/6, \\ a_2 + 8a_3 + a_4 + 27a_5 + 8a_6 &= 0, & a_4 + 8a_6 &= -1/3, \end{aligned}$$

whose unique solution is

$$a_1 = \frac{185}{24}, \quad a_2 = -\frac{20}{3}, \quad a_3 = \frac{25}{8}, \quad a_4 = 2, \quad a_5 = -\frac{2}{3}, \quad a_6 = -\frac{7}{24},$$

with a norm $\|\mu_{2,(-1,-1)}\|_\infty \approx 30.92$.

If we want a functional with a smaller norm, we can add a parameter: a_7 . For example we consider the following coefficients

$$\mu'_{2,(-1,-1)}(f) = \mu_{2,(-1,-1)}(f) + a_7(f_{2,1} + f_{1,2}), \quad (14)$$

$$\mu'_{2,(-1,-1)}(f) = \mu_{2,(-1,-1)}(f) + a_7(f_{4,0} + f_{0,4}), \quad (15)$$

$$\mu'_{2,(-1,-1)}(f) = \mu_{2,(-1,-1)}(f) + a_7 f_{3,3}. \quad (16)$$

In each example the parameter a_7 is associated with different data points.

Solving the corresponding systems and minimizing the norm $\|\mu'_{2,(-1,-1)}\|_\infty$, we obtain the values

$$\text{case (14): } \|\mu'_{2,(-1,-1)}\|_\infty \approx 27.92,$$

$$\text{case (15): } \|\mu'_{2,(-1,-1)}\|_\infty = 22,$$

$$\text{case (16): } \|\mu'_{2,(-1,-1)}\|_\infty \approx 12.56.$$

Therefore we choose the functional proposed in (16), where

$$a_1 = \frac{35}{9}, \quad a_2 = -\frac{5}{12}, \quad a_3 = 0, \quad a_4 = -\frac{17}{4}, \quad a_5 = \frac{1}{36}, \quad a_6 = \frac{17}{6}, \quad a_7 = -\frac{25}{36}.$$

In the same manner, we add the parameter a_8 , considering for example

$$\mu''_{2,(-1,-1)}(f) = \mu_{2,(-1,-1)}(f) + a_7 f_{3,3} + a_8(f_{2,1} + f_{1,2}), \quad (17)$$

$$\mu''_{2,(-1,-1)}(f) = \mu_{2,(-1,-1)}(f) + a_7 f_{3,3} + a_8(f_{4,0} + f_{0,4}), \quad (18)$$

$$\mu''_{2,(-1,-1)}(f) = \mu_{2,(-1,-1)}(f) + a_7 f_{3,3} + a_8 f_{4,4}. \quad (19)$$

Solving the corresponding systems and minimizing the norm $\|\mu''_{2,(-1,-1)}\|_\infty$, we obtain the values

$$\text{case (17): } \|\mu''_{2,(-1,-1)}\|_\infty \approx 12.56,$$

$$\text{case (18): } \|\mu''_{2,(-1,-1)}\|_\infty = 12.5,$$

$$\text{case (19): } \|\mu''_{2,(-1,-1)}\|_\infty = 8.125.$$

Therefore we choose the functional proposed in (19), where

$$\begin{aligned} a_1 &= \frac{1351}{432}, & a_2 &= 0, & a_3 &= -\frac{5}{24}, & a_4 &= -\frac{95}{36}, \\ a_5 &= \frac{2}{27}, & a_6 &= 0, & a_7 &= \frac{139}{108}, & a_8 &= -\frac{73}{144}. \end{aligned}$$

and with discrete support shown in Fig. 9(a).

For the other cases we use the same technique: we start with an initial scheme containing an equal number of conditions and unknowns and then, in order to reduce the infinity norm, we add points searching the ‘good direction’.

The ‘good direction’ for which we have the smallest norm is given by the vertical line $x - ih = 0$, i.e. the vertical line through the center of the support, or, in special cases of functionals symmetric with respect to x and y , the diagonal line $x - y = 0$ (or $x + y - m_1 h = 0$), on which we choose the data points. We obtain the functionals with discrete supports shown in Figs. 8÷11.

By the functional construction (see e.g. the construction of $\mu_{2,(-1,-1)}$), we notice that the infinity norm of the coefficient functionals reduces when more parameters are added, but this reduction slows down as the number of parameters increases. It would be interesting to analyse in detail the convergence of this reduction.

The method proposed for the construction of near-best boundary coefficient functionals is a heuristic technique that proceeds gradually adding at each step one new parameter and taking into account the ‘good position’ of the parameters obtained in the previous step.

Another technique consists in the search of the very best solution (i.e. with the smallest infinity norm out of all possible combinations of data points) for a fixed number of parameters, that can be formulated as a single integer programming problem. We have decided to solve this sequence of linear programming problems because is simpler from a computational point of view.

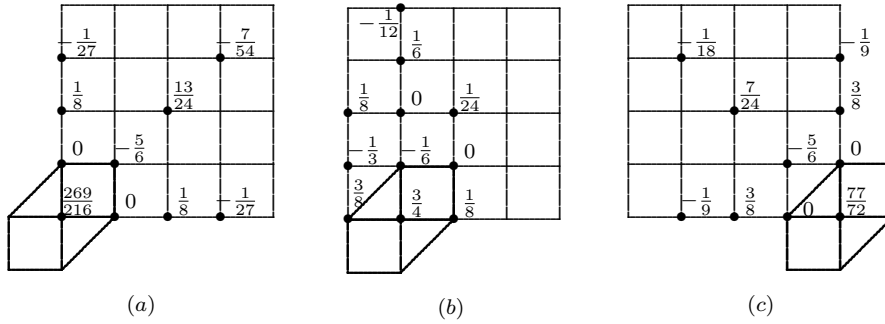

Fig. 8 Near-best functionals associated with $\bar{\varphi}_{1,(0,0)}$ (a), $\bar{\varphi}_{1,(1,0)}$ (b) and $\bar{\varphi}_{1,(m_1,0)}$ (c)

Therefore we define the discrete QI Q_1

$$Q_1 f = \sum_{\alpha \in \mathcal{A}_2} [\mu_{1,\alpha}(f), \mu_{2,\alpha}(f)] \bar{\varphi}_\alpha, \quad (20)$$

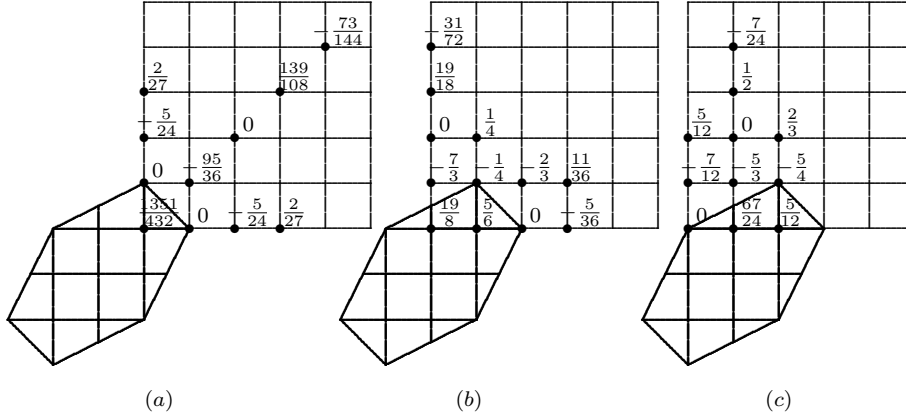

Fig. 9 Near-best functionals associated with $\bar{\varphi}_{2,(-1,-1)}$ (a), $\bar{\varphi}_{2,(0,-1)}$ (b) and $\bar{\varphi}_{2,(1,-1)}$ (c)

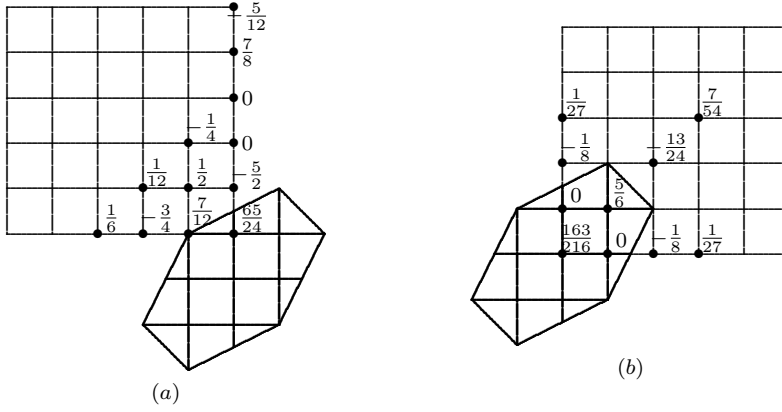

Fig. 10 Near-best functionals associated with $\bar{\varphi}_{2,(m_1,-1)}$ (a) and $\bar{\varphi}_{2,(0,0)}$ (b)

giving the expression of its coefficient functionals. Thanks to symmetry properties, only the following functionals are required:

$$\mu_{1,(0,0)}(f) = \frac{269}{216}f_{0,0} + \frac{1}{8}(f_{2,0} + f_{0,2}) - \frac{5}{6}f_{1,1} - \frac{1}{27}(f_{3,0} + f_{0,3}) + \frac{13}{24}f_{2,2} - \frac{7}{54}f_{3,3},$$

$$\mu_{1,(m_1,0)}(f) = \frac{77}{72}fm_{1,0} + \frac{3}{8}(fm_{1-2,0} + fm_{1,2}) - \frac{5}{6}fm_{1-1,1} - \frac{1}{9}(fm_{1-3,0} + fm_{1,3}) + \frac{7}{24}fm_{1-2,2} - \frac{1}{18}fm_{1-3,3},$$

$$\mu_{2,(-1,-1)}(f) = \frac{1351}{432}f_{0,0} - \frac{5}{24}(f_{2,0} + f_{0,2}) - \frac{95}{36}f_{1,1} + \frac{2}{27}(f_{3,0} + f_{0,3}) + \frac{139}{108}f_{3,3} - \frac{73}{144}f_{4,4},$$

$$\mu_{2,(0,-1)}(f) = \frac{19}{8}f_{0,0} + \frac{5}{6}f_{1,0} - \frac{5}{36}f_{3,0} - \frac{7}{3}f_{0,1} - \frac{1}{4}f_{1,1} - \frac{2}{3}f_{2,1} + \frac{1}{4}f_{1,2} + \frac{19}{18}f_{0,3} + \frac{11}{36}f_{3,1} - \frac{31}{72}f_{0,4},$$

$$\mu_{2,(m_1,-1)}(f) = \frac{65}{24}fm_{1,0} + \frac{7}{12}fm_{1-1,0} - \frac{3}{4}fm_{1-2,0} + \frac{1}{6}fm_{1-3,0} - \frac{5}{2}fm_{1,1} + \frac{1}{2}fm_{1-1,1} + \frac{1}{12}fm_{1-2,1} - \frac{1}{4}fm_{1-1,2} + \frac{7}{8}fm_{1,4} - \frac{5}{12}fm_{1,5},$$

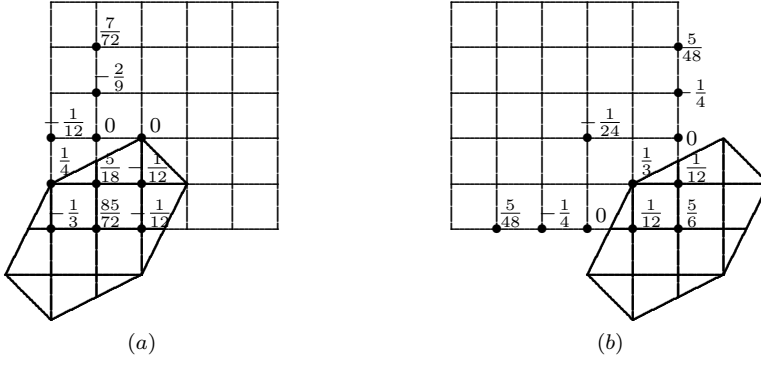

Fig. 11 Near-best functionals associated with $\bar{\varphi}_{2,(1,0)}$ (a) and $\bar{\varphi}_{2,(m_1,0)}$ (b)

$$\begin{aligned} \mu_{2,(0,0)}(f) &= \frac{163}{216}f_{0,0} - \frac{1}{8}(f_{2,0} + f_{0,2}) + \frac{5}{6}f_{1,1} \\ &\quad + \frac{1}{27}(f_{3,0} + f_{0,3}) - \frac{13}{24}f_{2,2} + \frac{7}{54}f_{3,3}, \end{aligned}$$

$$\begin{aligned} \mu_{2,(m_1,0)}(f) &= \frac{5}{6}f_{m_1,0} + \frac{1}{12}(f_{m_1-1,0} + f_{m_1,1}) + \frac{1}{3}f_{m_1-1,1} \\ &\quad - \frac{1}{4}(f_{m_1-3,0} + f_{m_1,3}) - \frac{1}{24}f_{m_1-2,2} + \frac{5}{48}(f_{m_1-4,0} + f_{m_1,4}). \end{aligned}$$

Along the lower edge, for $i = 1, \dots, m_1 - 1$, we have

$$\begin{aligned} \mu_{1,(i,0)}(f) &= \frac{3}{8}f_{i-1,0} + \frac{3}{4}f_{i,0} + \frac{1}{8}f_{i+1,0} - \frac{1}{3}f_{i-1,1} - \frac{1}{6}f_{i,1} \\ &\quad + \frac{1}{8}f_{i-1,2} + \frac{1}{24}f_{i+1,2} + \frac{1}{6}f_{i,3} - \frac{1}{12}f_{i,4}, \end{aligned}$$

$$\begin{aligned} \mu_{2,(i,-1)}(f) &= \frac{67}{24}f_{i,0} + \frac{5}{12}f_{i+1,0} - \frac{7}{12}f_{i-1,1} - \frac{5}{3}f_{i,1} - \frac{5}{4}f_{i+1,1} \\ &\quad + \frac{5}{12}f_{i-1,2} + \frac{2}{3}f_{i+1,2} + \frac{1}{2}f_{i,3} - \frac{7}{24}f_{i,4}, \end{aligned}$$

$$\begin{aligned} \mu_{2,(i,0)}(f) &= -\frac{1}{3}f_{i-1,0} + \frac{85}{72}f_{i,0} - \frac{1}{12}f_{i+1,0} + \frac{1}{4}f_{i-1,1} + \frac{5}{18}f_{i,1} - \frac{1}{12}f_{i+1,1} \\ &\quad - \frac{1}{12}f_{i-1,2} - \frac{2}{9}f_{i,3} + \frac{7}{72}f_{i,4}, \end{aligned}$$

and analogous formulas for the three other edges and vertices of Ω . In the interior of the domain, for $i = 1, \dots, m_1 - 1$, $j = 1, \dots, m_2 - 1$, the coefficient functionals are defined by (5) and (6) i.e.

$$\begin{aligned} \mu_{1,(i,j)}(f) &= \frac{1}{3}f_{i,j} + \frac{1}{6}(f_{i+1,j} + f_{i-1,j} + f_{i,j+1} + f_{i,j-1}) \\ &\quad + \frac{1}{24}(f_{i+1,j+1} + f_{i-1,j-1} - f_{i+1,j-1} - f_{i-1,j+1}), \end{aligned}$$

$$\begin{aligned} \mu_{2,(i,j)}(f) &= \frac{5}{3}f_{i,j} - \frac{1}{6}(f_{i+1,j} + f_{i-1,j} + f_{i,j+1} + f_{i,j-1}) \\ &\quad - \frac{1}{24}(f_{i+1,j+1} + f_{i-1,j-1} - f_{i+1,j-1} - f_{i-1,j+1}). \end{aligned}$$

In Table 1 we give the values of the infinity norms of the coefficient functionals.

A valid choice as boundary coefficient functionals is also represented by the initial ones with schemes containing an equal number of conditions and unknowns, where no minimization procedures are required. These coefficient functionals, denoted by $[\bar{\mu}_{1,\alpha}(f), \bar{\mu}_{2,\alpha}(f)]$ are:

$$\begin{aligned} \bar{\mu}_{1,(0,0)}(f) &= \frac{47}{24}f_{0,0} - \frac{7}{6}(f_{1,0} + f_{0,1}) + \frac{17}{24}(f_{2,0} + f_{0,2}) + \frac{1}{3}f_{1,1} \\ &\quad - \frac{1}{6}(f_{3,0} + f_{0,3}) - \frac{1}{24}f_{2,2}, \end{aligned}$$

$$\begin{aligned} \bar{\mu}_{1,(m_1,0)}(f) &= \frac{11}{8}f_{m_1,0} - \frac{1}{2}(f_{m_1-1,0} + f_{m_1,1}) + \frac{5}{8}(f_{m_1-2,0} + f_{m_1,2}) - \frac{1}{3}f_{m_1-1,1} \\ &\quad - \frac{1}{6}(f_{m_1-3,0} + f_{m_1,3}) + \frac{1}{24}f_{m_1-2,2}, \end{aligned}$$

$\ \mu_{1,(0,0)}\ _\infty = \frac{83}{27} \approx 3.07$	$\ \mu_{1,(i,0)}\ _\infty = \frac{13}{6} \approx 2.17$
$\ \mu_{1,(m_1,0)}\ _\infty = \frac{29}{9} \approx 3.22$	$\ \mu_{1,(i,j)}\ _\infty = \frac{7}{6} \approx 1.17$
$\ \mu_{2,(-1,-1)}\ _\infty = \frac{65}{8} = 8.125$	$\ \mu_{2,(0,-1)}\ _\infty = \frac{311}{36} \approx 8.64$
$\ \mu_{2,(i,-1)}\ _\infty = \frac{103}{12} \approx 8.58$	$\ \mu_{2,(m_1,-1)}\ _\infty = \frac{53}{6} \approx 8.83$
$\ \mu_{2,(0,0)}\ _\infty = \frac{31}{12} \approx 2.58$	$\ \mu_{2,(i,0)}\ _\infty = \frac{47}{18} \approx 2.61$
$\ \mu_{2,(m_1,0)}\ _\infty = \frac{25}{12} \approx 2.08$	$\ \mu_{2,(i,j)}\ _\infty = \frac{5}{2} = 2.5$

Table 1 Infinity norms of the coefficient functionals of Q_1

$$\bar{\mu}_{2,(-1,-1)}(f) = \frac{185}{24}f_{0,0} - \frac{20}{3}(f_{1,0} + f_{0,1}) + \frac{25}{8}(f_{2,0} + f_{0,2}) + 2f_{1,1} - \frac{2}{3}(f_{3,0} + f_{0,3}) - \frac{7}{24}f_{2,2},$$

$$\bar{\mu}_{2,(0,-1)}(f) = \frac{5}{2}f_{0,0} + \frac{7}{4}f_{1,0} - \frac{11}{12}f_{2,0} + \frac{1}{6}f_{3,0} - \frac{15}{4}f_{0,1} - \frac{7}{6}f_{1,1} + \frac{1}{4}f_{2,1} + \frac{31}{12}f_{0,2} + \frac{1}{4}f_{1,2} - \frac{2}{3}f_{0,3},$$

$$\bar{\mu}_{2,(m_1,-1)}(f) = \frac{7}{2}f_{m_1,0} + \frac{7}{12}f_{m_1-1,0} - \frac{3}{4}f_{m_1-2,0} + \frac{1}{6}f_{m_1-3,0} - \frac{21}{4}f_{m_1,1} + \frac{1}{2}f_{m_1-1,1} + \frac{1}{12}f_{m_1-2,1} + \frac{37}{12}f_{m_1,2} - \frac{1}{4}f_{m_1-1,2} - \frac{2}{3}f_{m_1,3},$$

$$\bar{\mu}_{2,(0,0)}(f) = \frac{1}{24}f_{0,0} + \frac{7}{6}(f_{1,0} + f_{0,1}) - \frac{17}{24}(f_{2,0} + f_{0,2}) - \frac{1}{3}f_{1,1} + \frac{1}{6}(f_{3,0} + f_{0,3}) + \frac{1}{24}f_{2,2},$$

$$\bar{\mu}_{2,(m_1,0)}(f) = \frac{5}{8}f_{m_1,0} + \frac{1}{2}(f_{m_1-1,0} + f_{m_1,1}) - \frac{5}{8}(f_{m_1-2,0} + f_{m_1,2}) + \frac{1}{3}f_{m_1-1,1} + \frac{1}{6}(f_{m_1-3,0} + f_{m_1,3}) - \frac{1}{24}f_{m_1-2,2}.$$

Along the lower edge, for $i = 1, \dots, m_1 - 1$, we have

$$\bar{\mu}_{1,(i,0)}(f) = \frac{3}{8}f_{i-1,0} + \frac{5}{6}f_{i,0} + \frac{1}{8}f_{i+1,0} - \frac{1}{3}f_{i-1,1} - \frac{1}{2}f_{i,1} + \frac{1}{8}f_{i-1,2} + \frac{1}{2}f_{i,2} + \frac{1}{24}f_{i+1,2} - \frac{1}{6}f_{i,3},$$

$$\bar{\mu}_{2,(i,-1)}(f) = \frac{37}{12}f_{i,0} + \frac{5}{12}f_{i+1,0} - \frac{7}{12}f_{i-1,1} - \frac{17}{6}f_{i,1} - \frac{5}{4}f_{i+1,1} + \frac{5}{12}f_{i-1,2} + \frac{7}{4}f_{i,2} + \frac{2}{3}f_{i+1,2} - \frac{2}{3}f_{i,3},$$

$$\bar{\mu}_{2,(i,0)}(f) = -\frac{1}{3}f_{i-1,0} + \frac{13}{12}f_{i,0} - \frac{1}{12}f_{i+1,0} + \frac{1}{4}f_{i-1,1} + \frac{2}{3}f_{i,1} - \frac{1}{12}f_{i+1,1} - \frac{1}{12}f_{i-1,2} - \frac{7}{12}f_{i,2} + \frac{1}{6}f_{i,3},$$

and analogous formulas for the three other edges and vertices of Ω . In the interior of the domain, for $i = 1, \dots, m_1 - 1$, $j = 1, \dots, m_2 - 1$, the coefficient functionals are defined by (5) and (6). We call the corresponding operator \bar{Q}_1

$$\bar{Q}_1 f = \sum_{\alpha \in \mathcal{A}_2} [\bar{\mu}_{1,\alpha}(f), \bar{\mu}_{2,\alpha}(f)] \bar{\varphi}_\alpha. \quad (21)$$

In fact, in order to determine the coefficient functionals $\bar{\mu}_{1,(i,0)}$, $\bar{\mu}_{2,(i,-1)}$, $\bar{\mu}_{2,(i,0)}$, although the number of conditions and unknowns is the same, one parameter is free and a minimization problem has to be solved.

4 Construction of boundary functionals inducing superconvergence

In this section we construct boundary coefficient functionals inducing superconvergence of the gradient of the quasi-interpolant Q_2f at some specific points of the domain. Using the notations

$$s_0 = 0, s_i = (i - \frac{1}{2})h, 1 \leq i \leq m_1, s_{m_1+1} = m_1h, \\ t_0 = 0, t_j = (j - \frac{1}{2})h, 1 \leq j \leq m_2, t_{m_2+1} = m_2h,$$

these specific points are (see Fig. 7):

- the vertices of squares $A_{k,l} = (kh, lh)$, $k = 0, \dots, m_1, l = 0, \dots, m_2$,
- the centers of squares $M_{k,l} = (s_k, t_l)$, $k = 1, \dots, m_1, l = 1, \dots, m_2$,
- the midpoints $C_{k,l} = (s_k, lh)$ of horizontal edges $A_{k-1,l}A_{k,l}$, $k = 1, \dots, m_1, l = 0, \dots, m_2$,
- the midpoints $D_{k,l} = (kh, t_l)$ of vertical edges $A_{k,l-1}A_{k,l}$, $k = 0, \dots, m_1, l = 1, \dots, m_2$.

We construct the boundary coefficient functionals $\lambda_{1,\alpha}(f)$ and $\lambda_{2,\alpha}(f)$ so that they coincide, respectively, with the differential ones $(f + \frac{h^2}{6}\Delta^*f)(c_\alpha)$ and $(f - \frac{h^2}{6}\Delta^*f)(c_\alpha)$ for $f \in \mathbb{P}_3(\mathbb{R}^2)$.

Since the differential quasi-interpolant (2) is exact on $\mathbb{P}_3(\mathbb{R}^2)$, the discrete quasi-interpolant that we are constructing is also exact on $\mathbb{P}_3(\mathbb{R}^2)$, therefore the approximation order is 4 and the approximation order of the gradient is 3 for smooth functions, i.e. $f - Q_2f = O(h^4)$ and $\nabla(f - Q_2f) = O(h^3)$.

If we want superconvergence of the gradient at some specific points, i.e. $\nabla(f - Q_2f)(M) = O(h^4)$, we have to require that, for $f \in \mathbb{P}_4(\mathbb{R}^2)$, the gradient of the quasi-interpolant ∇Q_2f interpolates the gradient of the function ∇f at those points. So we impose $\nabla(Q_2f)(M) = \nabla f(M)$ for $f \in \mathbb{P}_4(\mathbb{R}^2) \setminus \mathbb{P}_3(\mathbb{R}^2)$, with M a specific point of the domain.

This leads to a system of linear equations. We consider systems with additional free parameters and we choose them by minimizing the infinity norms $\|\lambda_{1,\alpha}\|_\infty, \|\lambda_{2,\alpha}\|_\infty$ and solving the corresponding l_1 -minimization problems.

We remark that on the whole plane \mathbb{R}^2 , the two operators Q^* and Q^{**} , defined by (3) and (4), show superconvergence properties for the gradient at the points above specified (see [11]), i.e. $\nabla(f - Q^*f)(M) = O(h^4)$ and $\nabla(f - Q^{**}f)(M) = O(h^4)$ for smooth functions and for any point M of the type $A_{k,l}, M_{k,l}, C_{k,l}$ or $D_{k,l}$.

Hereinafter we analyse the coefficient functionals near the origin of Ω , the other ones can be obtained in a similar way near the other vertices. We consider schemes for these coefficient functionals containing a number of points greater than or equal to the number of imposed conditions and such that those points are included in a neighbourhood of the support of the corresponding scaled multi-box spline. In the selection of points we take into account the comments made in the previous section on the ‘good direction’.

We remark that in order to construct functionals inducing superconvergence near the origin, we have to impose the interpolation of the gradient at the specific points above defined. Therefore we start at the points where only one kind of boundary functional is involved, i.e. the points $(\frac{3}{2}h, \frac{3}{2}h), (2h, h), (2h, \frac{3}{2}h)$.

In fact, if we evaluate the quasi-interpolant Q_2 at the point $(\frac{3}{2}h, \frac{3}{2}h)$ (analogously at the points $(2h, h)$, $(2h, \frac{3}{2}h)$) we have:

$$\begin{aligned} Q_2 f\left(\frac{3}{2}h, \frac{3}{2}h\right) &= \lambda_{1,(1,1)}(f)\bar{\varphi}_{1,(1,1)}\left(\frac{3}{2}h, \frac{3}{2}h\right) + \lambda_{1,(2,2)}(f)\bar{\varphi}_{1,(2,2)}\left(\frac{3}{2}h, \frac{3}{2}h\right) \\ &\quad + \lambda_{2,(1,0)}(f)\bar{\varphi}_{2,(1,0)}\left(\frac{3}{2}h, \frac{3}{2}h\right) + \lambda_{2,(0,1)}(f)\bar{\varphi}_{2,(0,1)}\left(\frac{3}{2}h, \frac{3}{2}h\right) \\ &\quad + \lambda_{2,(1,1)}(f)\bar{\varphi}_{2,(1,1)}\left(\frac{3}{2}h, \frac{3}{2}h\right) + \lambda_{2,(2,1)}(f)\bar{\varphi}_{2,(2,1)}\left(\frac{3}{2}h, \frac{3}{2}h\right) \\ &\quad + \lambda_{2,(1,2)}(f)\bar{\varphi}_{2,(1,2)}\left(\frac{3}{2}h, \frac{3}{2}h\right) + \lambda_{2,(2,2)}(f)\bar{\varphi}_{2,(2,2)}\left(\frac{3}{2}h, \frac{3}{2}h\right) \\ &\quad + \lambda_{2,(3,2)}(f)\bar{\varphi}_{2,(3,2)}\left(\frac{3}{2}h, \frac{3}{2}h\right) + \lambda_{2,(2,3)}(f)\bar{\varphi}_{2,(2,3)}\left(\frac{3}{2}h, \frac{3}{2}h\right), \end{aligned}$$

where $\bar{\varphi}_{1,(1,1)}$, $\bar{\varphi}_{1,(2,2)}$, $\bar{\varphi}_{2,(1,1)}$, $\bar{\varphi}_{2,(2,1)}$, $\bar{\varphi}_{2,(1,2)}$, $\bar{\varphi}_{2,(2,2)}$, $\bar{\varphi}_{2,(3,2)}$, $\bar{\varphi}_{2,(2,3)}$ are associated with coefficient functionals of inner type defined by (5), (6) and $\bar{\varphi}_{2,(1,0)}$, $\bar{\varphi}_{2,(0,1)}$ are associated with boundary coefficient functionals. The supports of $\varphi_{2,(1,0)}$ and $\varphi_{2,(0,1)}$ are symmetric w.r.t. the line $y = x$, therefore we only construct the functional $\lambda_{2,(1,0)}$, because $\lambda_{2,(0,1)}$ can be obtained by symmetry. Thus we impose the interpolation condition for the gradient at these points and construct $\lambda_{2,(1,0)}$.

Then we consider the points (h, h) , $(\frac{3}{2}h, h)$: following the same logical scheme above explained and imposing the interpolation condition at these points, we construct $\lambda_{2,(0,0)}$. Then we consider the points $(2h, 0)$, $(2h, \frac{h}{2})$, $(\frac{3}{2}h, \frac{h}{2})$: imposing the interpolation condition at these points, we construct $\lambda_{2,(1,-1)}$, $\lambda_{1,(1,0)}$ and we continue using the same method.

Here we use more data points than in the near-best case, because now we have more conditions to impose.

We analyse the cases $\lambda_{2,(1,0)}$ and $\lambda_{2,(0,0)}$. For the other cases we follow the same logical scheme (see [20] for detail). We obtain the functionals with discrete supports shown in Figs. 12÷15.

4.1 Example 1: the functional $\lambda_{2,(1,0)}$

Consider the 13-point linear functional

$$\begin{aligned} \lambda_{2,(1,0)}(f) &= a_1 f_{0,0} + a_2 f_{1,0} + a_3 f_{2,0} + a_4 f_{0,1} + a_5 f_{1,1} + a_6 f_{2,1} + a_7 f_{0,2} + \\ &\quad + a_8 f_{1,2} + a_9 f_{2,2} + a_{10} f_{0,3} + a_{11} f_{1,3} + a_{12} f_{2,3} + a_{13} f_{1,4}, \end{aligned}$$

obtained from the scheme of the corresponding near-best coefficient functional by adding the points $A_{0,3} = (0, 3h)$ and $A_{2,3} = (2h, 3h)$.

We require that:

- (i) $\lambda_{2,(1,0)}(f) \equiv (f - \frac{h^2}{6}\Delta^* f)(c_{1,0})$, $c_{1,0} = (h, 0)$ for $f \in \mathbb{P}_3(\mathbb{R}^2)$, i.e. for $f \equiv 1, x, y, x^2, xy, y^2, x^3, x^2y, xy^2, y^3$;
- (ii) $\nabla(Q_2 f)(M) = \nabla f(M)$ for $f \in \mathbb{P}_4(\mathbb{R}^2) \setminus \mathbb{P}_3(\mathbb{R}^2)$, i.e. for $f \equiv x^4, x^3y, x^2y^2, xy^3, y^4$ and $M = (\frac{3}{2}h, \frac{3}{2}h), (2h, h), (2h, \frac{3}{2}h)$.

This leads to a system whose solution depends on one parameter: if we minimize the norm $\|\lambda_{2,(1,0)}\|_\infty$ we obtain

$$\begin{aligned} a_1 &= -\frac{31}{72}, & a_2 &= \frac{37}{36}, & a_3 &= -\frac{7}{72}, & a_4 &= \frac{7}{12}, & a_5 &= \frac{11}{12}, & a_6 &= 0, \\ a_7 &= -\frac{11}{24}, & a_8 &= -\frac{13}{12}, & a_9 &= -\frac{1}{8}, & a_{10} &= \frac{5}{36}, & a_{11} &= \frac{23}{36}, \\ a_{12} &= \frac{1}{18}, & a_{13} &= -\frac{1}{6}, \end{aligned}$$

with a norm $\|\lambda_{2,(1,0)}\|_\infty \approx 5.72$ and discrete support shown in Fig. 12(a).

4.2 Example 2: the functional $\lambda_{2,(0,0)}$

We consider the 15-point linear functional, defined using 10 unknowns

$$\lambda_{2,(0,0)}(f) = a_1 f_{0,0} + a_2(f_{1,0} + f_{0,1}) + a_3(f_{2,0} + f_{0,2}) + a_4 f_{1,1} + a_5(f_{3,0} + f_{0,3}) \\ + a_6(f_{2,1} + f_{1,2}) + a_7(f_{4,0} + f_{0,4}) + a_8 f_{2,2} + a_9 f_{3,3} + a_{10} f_{4,4},$$

obtained from the scheme of the corresponding near-best coefficient functional by adding the points $A_{0,4} = (0, 4h)$, $A_{4,0} = (4h, 0)$, $A_{1,2} = (h, 2h)$, $A_{2,1} = (2h, h)$ and $A_{4,4} = (4h, 4h)$.

We require that:

- (i) $\lambda_{2,(0,0)}(f) \equiv (f - \frac{h^2}{6} \Delta^* f)(0, 0)$ for $f \in \mathbb{P}_3(\mathbb{R}^2)$;
- (ii) $\nabla(Qf)(M) = \nabla f(M)$ for $f \in \mathbb{P}_4(\mathbb{R}^2) \setminus \mathbb{P}_3(\mathbb{R}^2)$ and $M = (h, h)$, $(\frac{3}{2}h, h)$.

Solving the corresponding system and minimizing the norm we obtain

$$a_1 = \frac{23}{36}, \quad a_2 = 0, \quad a_3 = -\frac{7}{24}, \quad a_4 = \frac{19}{12}, \quad a_5 = \frac{7}{36}, \\ a_6 = -\frac{1}{12}, \quad a_7 = -\frac{1}{24}, \quad a_8 = -\frac{31}{24}, \quad a_9 = \frac{23}{36}, \quad a_{10} = -\frac{1}{8},$$

with a norm $\|\lambda_{2,(0,0)}\|_\infty = 5.5$ and discrete support shown in Fig. 12(b).

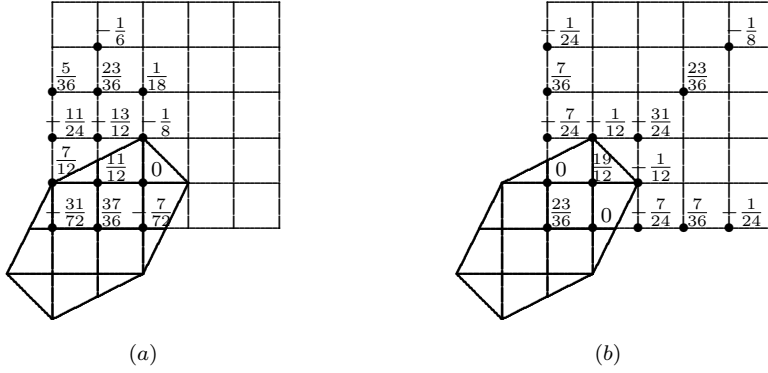

Fig. 12 Functionals inducing superconvergence associated with $\bar{\varphi}_{2,(1,0)}$ (a) and $\bar{\varphi}_{2,(0,0)}$ (b)

Therefore we define the discrete QI Q_2

$$Q_2 f = \sum_{\alpha \in \mathcal{A}_2} [\lambda_{1,\alpha}(f), \lambda_{2,\alpha}(f)] \bar{\varphi}_\alpha, \quad (22)$$

giving the expression of its coefficient functionals. Thanks to symmetry properties, only the following functionals are required:

$$\lambda_{1,(0,0)}(f) = \frac{49}{36} f_{0,0} + \frac{7}{24} (f_{2,0} + f_{0,2}) - \frac{19}{12} f_{1,1} - \frac{7}{36} (f_{3,0} + f_{0,3}) \\ + \frac{1}{12} (f_{2,1} + f_{1,2}) + \frac{1}{24} (f_{4,0} + f_{0,4}) + \frac{31}{24} f_{2,2} - \frac{23}{36} f_{3,3} + \frac{1}{8} f_{4,4},$$

$$\lambda_{1,(m_1,0)}(f) = \frac{35}{24} f_{m_1,0} - \frac{2}{3} (f_{m_1-1,0} + f_{m_1,1}) + \frac{31}{24} (f_{m_1-2,0} + f_{m_1,2}) \\ - \frac{7}{6} f_{m_1-1,1} - \frac{3}{4} (f_{m_1-3,0} + f_{m_1,3}) + \frac{5}{12} (f_{m_1-2,1} + f_{m_1-1,2}) \\ + \frac{1}{6} (f_{m_1-4,0} + f_{m_1,4}) - \frac{1}{12} (f_{m_1-3,1} + f_{m_1-1,3}) - \frac{1}{24} f_{m_1-2,2},$$

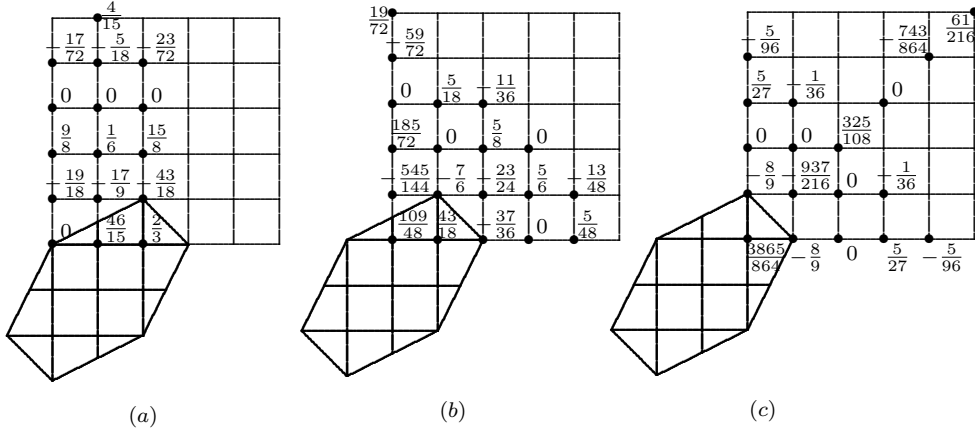

Fig. 13 Functionals inducing superconvergence associated with $\bar{\varphi}_{2,(1,-1)}$ (a), $\bar{\varphi}_{2,(0,-1)}$ (b) and $\bar{\varphi}_{2,(-1,-1)}$ (c)

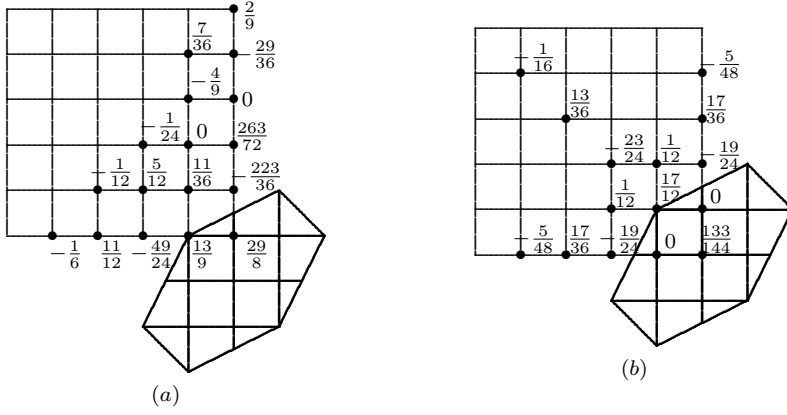

Fig. 14 Functionals inducing superconvergence associated with $\bar{\varphi}_{2,(m_1,-1)}$ (a) and $\bar{\varphi}_{2,(m_1,0)}$ (b)

$$\begin{aligned} \lambda_{2,(-1,-1)}(f) &= \frac{3865}{864} f_{0,0} - \frac{8}{9} (f_{1,0} + f_{0,1}) - \frac{937}{216} f_{1,1} + \frac{5}{27} (f_{3,0} + f_{0,3}) \\ &\quad - \frac{5}{96} (f_{4,0} + f_{0,4}) - \frac{1}{36} (f_{3,1} + f_{1,3}) + \frac{325}{108} f_{2,2} \\ &\quad - \frac{743}{864} f_{4,4} + \frac{61}{216} f_{5,5}, \end{aligned}$$

$$\begin{aligned} \lambda_{2,(0,-1)}(f) &= \frac{109}{48} f_{0,0} + \frac{43}{18} f_{1,0} - \frac{37}{36} f_{2,0} + \frac{5}{48} f_{4,0} - \frac{545}{144} f_{0,1} - \frac{7}{6} f_{1,1} \\ &\quad - \frac{23}{24} f_{2,1} + \frac{5}{6} f_{3,1} - \frac{13}{48} f_{4,1} + \frac{185}{72} f_{0,2} + \frac{5}{8} f_{2,2} \\ &\quad + \frac{5}{18} f_{1,3} - \frac{11}{36} f_{2,3} - \frac{59}{72} f_{0,4} + \frac{19}{72} f_{0,5}, \end{aligned}$$

$$\begin{aligned} \lambda_{2,(m_1,-1)}(f) &= \frac{29}{8} f_{m_1,0} + \frac{13}{9} f_{m_1-1,0} - \frac{49}{24} f_{m_1-2,0} + \frac{11}{12} f_{m_1-3,0} - \frac{1}{6} f_{m_1-4,0} \\ &\quad - \frac{223}{36} f_{m_1,1} + \frac{11}{36} f_{m_1-1,1} + \frac{5}{12} f_{m_1-2,1} - \frac{1}{12} f_{m_1-3,1} + \frac{263}{72} f_{m_1,2} \\ &\quad - \frac{1}{24} f_{m_1-2,2} - \frac{4}{9} f_{m_1-1,3} - \frac{29}{36} f_{m_1,4} + \frac{7}{36} f_{m_1-1,4} + \frac{2}{9} f_{m_1,5}, \end{aligned}$$

$$\begin{aligned} \lambda_{2,(0,0)}(f) &= \frac{23}{36} f_{0,0} - \frac{7}{24} (f_{2,0} + f_{0,2}) + \frac{19}{12} f_{1,1} + \frac{7}{36} (f_{3,0} + f_{0,3}) \\ &\quad - \frac{1}{12} (f_{2,1} + f_{1,2}) - \frac{1}{24} (f_{4,0} + f_{0,4}) - \frac{31}{24} f_{2,2} + \frac{23}{36} f_{3,3} - \frac{1}{8} f_{4,4}, \end{aligned}$$

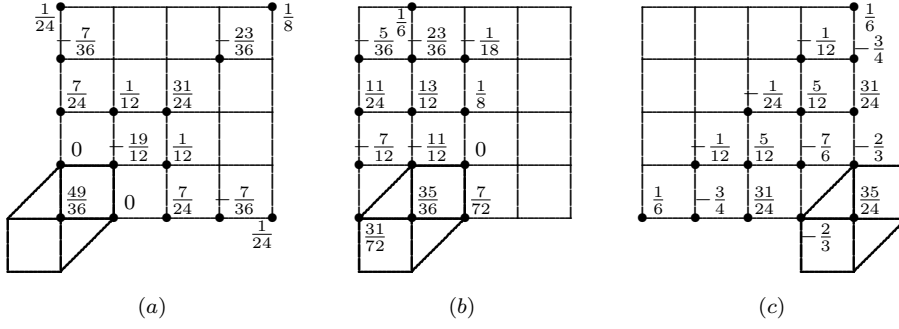

Fig. 15 Functionals inducing superconvergence associated with $\bar{\varphi}_{1,(0,0)}$ (a), $\bar{\varphi}_{1,(1,0)}$ (b) and $\bar{\varphi}_{1,(m_1,0)}$ (c)

$$\begin{aligned} \lambda_{2,(m_1,0)}(f) &= \frac{133}{144}f_{m_1,0} - \frac{19}{24}(f_{m_1-2,0} + f_{m_1,2}) + \frac{17}{12}f_{m_1-1,1} \\ &\quad + \frac{17}{36}(f_{m_1-3,0} + f_{m_1,3}) + \frac{1}{12}(f_{m_1-2,1} + f_{m_1-1,2}) \\ &\quad - \frac{5}{48}(f_{m_1-4,0} + f_{m_1,4}) - \frac{23}{24}f_{m_1-2,2} + \frac{13}{36}f_{m_1-3,3} - \frac{1}{16}f_{m_1-4,4}. \end{aligned}$$

Along the lower edge, for $i = 1, \dots, m_1 - 1$, we have

$$\begin{aligned} \lambda_{1,(i,0)}(f) &= \frac{31}{72}f_{i-1,0} + \frac{35}{36}f_{i,0} + \frac{7}{72}f_{i+1,0} - \frac{7}{12}f_{i-1,1} - \frac{11}{12}f_{i,1} + \frac{11}{24}f_{i-1,2} \\ &\quad + \frac{13}{12}f_{i,2} + \frac{1}{8}f_{i+1,2} - \frac{5}{36}f_{i-1,3} - \frac{23}{36}f_{i,3} - \frac{1}{18}f_{i+1,3} + \frac{1}{6}f_{i,4}, \end{aligned}$$

$$\begin{aligned} \lambda_{2,(i,-1)}(f) &= \frac{46}{15}f_{i,0} + \frac{2}{3}f_{i+1,0} - \frac{19}{18}f_{i-1,1} - \frac{17}{9}f_{i,1} - \frac{43}{18}f_{i+1,1} + \frac{9}{8}f_{i-1,2} \\ &\quad + \frac{1}{6}f_{i,2} + \frac{15}{8}f_{i+1,2} - \frac{17}{72}f_{i-1,4} - \frac{5}{18}f_{i,4} - \frac{23}{72}f_{i+1,4} + \frac{4}{15}f_{i,5}, \end{aligned}$$

$$\begin{aligned} \lambda_{2,(i,0)}(f) &= -\frac{31}{72}f_{i-1,0} + \frac{37}{36}f_{i,0} - \frac{7}{72}f_{i+1,0} + \frac{7}{12}f_{i-1,1} + \frac{11}{12}f_{i,1} - \frac{11}{24}f_{i-1,2} \\ &\quad - \frac{13}{12}f_{i,2} - \frac{1}{8}f_{i+1,2} + \frac{5}{36}f_{i-1,3} + \frac{23}{36}f_{i,3} + \frac{1}{18}f_{i+1,3} - \frac{1}{6}f_{i,4}, \end{aligned}$$

and analogous formulas for the three other edges and vertices of Ω . In the interior of the domain, for $i = 1, \dots, m_1 - 1$, $j = 1, \dots, m_2 - 1$, the coefficient functionals are defined by (5) and (6) i.e.

$$\begin{aligned} \lambda_{1,(i,j)}(f) &= \frac{1}{3}f_{i,j} + \frac{1}{6}(f_{i+1,j} + f_{i-1,j} + f_{i,j+1} + f_{i,j-1}) \\ &\quad + \frac{1}{24}(f_{i+1,j+1} + f_{i-1,j-1} - f_{i+1,j-1} - f_{i-1,j+1}), \end{aligned}$$

$$\begin{aligned} \lambda_{2,(i,j)}(f) &= \frac{5}{3}f_{i,j} - \frac{1}{6}(f_{i+1,j} + f_{i-1,j} + f_{i,j+1} + f_{i,j-1}) \\ &\quad - \frac{1}{24}(f_{i+1,j+1} + f_{i-1,j-1} - f_{i+1,j-1} - f_{i-1,j+1}), \end{aligned}$$

In Table 2 we give the values of the infinity norms of the coefficient functionals.

5 Norm and error estimates

In order to study the infinity norms of both operators, Q_1 and Q_2 , we express them in terms of quasi-Lagrange functions $\mathbf{L}^{(v)} = [L_{\bar{\varphi}_1}^{(v)}, L_{\bar{\varphi}_2}^{(v)}]^T$ as follows

$$\begin{aligned} Q_1 f &= \sum_{\alpha \in \mathcal{A}_2} [\mu_{1,\alpha}(f), \mu_{2,\alpha}(f)] \bar{\varphi}_\alpha = \sum_{\alpha \in \mathcal{A}} [f_\alpha, f_\alpha] \mathbf{L}_\alpha^{(1)}, \\ Q_2 f &= \sum_{\alpha \in \mathcal{A}_2} [\lambda_{1,\alpha}(f), \lambda_{2,\alpha}(f)] \bar{\varphi}_\alpha = \sum_{\alpha \in \mathcal{A}} [f_\alpha, f_\alpha] \mathbf{L}_\alpha^{(2)}, \end{aligned}$$

$\ \lambda_{1,(0,0)}\ _\infty = \frac{56}{9} \approx 6.22$	$\ \lambda_{1,(i,0)}\ _\infty = \frac{17}{3} \approx 5.67$
$\ \lambda_{1,(m_1,0)}\ _\infty = \frac{113}{12} \approx 9.42$	$\ \lambda_{1,(i,j)}\ _\infty = \frac{7}{6} \approx 1.17$
$\ \lambda_{2,(-1,-1)}\ _\infty = \frac{733}{48} \approx 15.27$	$\ \lambda_{2,(0,-1)}\ _\infty = \frac{53}{3} \approx 17.67$
$\ \lambda_{2,(i,-1)}\ _\infty = \frac{40}{3} \approx 13.33$	$\ \lambda_{2,(m_1,-1)}\ _\infty = \frac{185}{9} \approx 20.56$
$\ \lambda_{2,(0,0)}\ _\infty = \frac{11}{2} = 5.5$	$\ \lambda_{2,(i,0)}\ _\infty = \frac{103}{18} \approx 5.72$
$\ \lambda_{2,(m_1,0)}\ _\infty = \frac{53}{8} = 6.625$	$\ \lambda_{2,(i,j)}\ _\infty = \frac{5}{2} = 2.5$

Table 2 Infinity norms of the coefficient functionals of Q_2

and we compute the infinity norm of their Lebesgue functions. The computation of a good upper bound is based upon a good upper bound of $\|\sum_\alpha |\mathbf{L}_\alpha^{(v)}|\|_\infty$, $v = 1, 2$.

This process is quite complex, but we know that for bounded functions f , a first upper bound for the infinity norm of a discrete quasi-interpolant can be obtained by taking the largest norm of its coefficient functionals. Therefore we can prove the following theorem.

Theorem 1 *For the operators Q_v , $v = 1, 2$, defined in Sections 3 and 4, the following bounds are valid*

$$\|Q_1\|_\infty \leq \frac{53}{6} \approx 8.83, \quad \|Q_2\|_\infty \leq \frac{185}{9} \approx 20.56.$$

Proof For $\|f\|_\infty \leq 1$, taking into account (10) and Tables 1-2, we bound above the infinity norm of the operator Q_1 by the infinity norm of the functional $\mu_{2,(m_1,-1)}$ and that of Q_2 by the norm of $\lambda_{2,(m_1,-1)}$. Therefore we obtain

$$\|Q_1\|_\infty \leq \frac{53}{6} \approx 8.83 \quad \text{and} \quad \|Q_2\|_\infty \leq \frac{185}{9} \approx 20.56.$$

□

Note that the actual infinity norms of Q_1 and Q_2 are smaller than these values.

Standard results in approximation theory (see also [11]) allow us to deduce the following theorem, where $D^\beta = D^{\beta_1\beta_2} = \frac{\partial^{|\beta|}}{\partial x^{\beta_1} \partial y^{\beta_2}}$, with $\beta_1 + \beta_2 = |\beta|$.

Theorem 2 *Let $f \in C^4(\Omega)$ and $|\gamma| = 0, 1, 2, 3$. Then there exist constants $K_{v,\gamma} > 0$, $v = 1, 2$, such that*

$$\|D^\gamma(f - Q_v f)\|_\infty \leq K_{v,\gamma} h^{4-|\gamma|} \max_{|\beta|=4} \|D^\beta f\|_\infty.$$

6 Numerical Results

In this section we present some numerical results obtained by computational procedures developed in a Matlab environment. These procedures are constructed by adapting those proposed in [8,9].

We approximate the following functions

$$f_1(x, y) = (y - x^2)^2 + (1 - x)^2, \quad \text{on the square } [-2, 2] \times [-2, 2],$$

$$f_2(x, y) = \ln(1 + x^2 + y^2), \quad \text{on the square } [-1, 1] \times [-1, 1],$$

and the Franke test function (see e.g. [12])

$$f_3(x, y) = \frac{3}{4} \exp\left(-\frac{1}{4}\left((9x-2)^2 + (9y-2)^2\right)\right) + \frac{3}{4} \exp\left(-\left(\frac{(9x+1)^2}{49} + \frac{(9y+1)^2}{10}\right)\right) \\ + \frac{1}{2} \exp\left(-\frac{1}{4}\left((9x-7)^2 + (9y-3)^2\right)\right) - \frac{1}{5} \exp\left(-\left((9x-4)^2 + (9y-7)^2\right)\right)$$

on the square $[0, 1] \times [0, 1]$.

6.1 Approximation of functions

For each test function, using a 300×300 uniform rectangular grid G of evaluation points in the domain, we compute the maximum absolute error $Ef = \max_{(u,v) \in G} |f(u, v) - Qf(u, v)|$, $Q = Q_1, \bar{Q}_1, Q_2, Q^*, Q^{**}$ (defined by (20), (21), (22), (3) and (4), respectively), for increasing values of m_1 and m_2 , and the logarithm of the ratio between two consecutive errors, rf , see Table 3.

We recall that the quasi-interpolant Q^* and Q^{**} use data points outside the domain.

$m_1 = m_2$	Q_1		\bar{Q}_1		Q_2		Q^*		Q^{**}	
	Ef	rf	Ef	rf	Ef	rf	Ef	rf	Ef	rf
f_1										
32	5.1(-4)		2.4(-4)		1.6(-4)		1.6(-4)		3.2(-5)	
64	3.2(-5)	4.0	1.5(-5)	4.0	9.9(-6)	4.0	9.9(-6)	4.0	2.0(-6)	4.0
128	2.0(-6)	4.0	9.4(-7)	4.0	6.2(-7)	4.0	6.2(-7)	4.0	1.2(-7)	4.0
256	6.7(-8)	4.9	3.9(-8)	4.6	3.9(-8)	4.0	3.9(-8)	4.0	7.7(-9)	4.0
f_2										
32	1.2(-5)		1.2(-5)		1.2(-5)		1.2(-5)		3.0(-6)	
64	7.7(-7)	4.0	7.7(-7)	4.0	7.7(-7)	4.0	7.7(-7)	4.0	1.8(-7)	4.1
128	4.8(-8)	4.0	4.8(-8)	4.0	4.8(-8)	4.0	4.8(-8)	4.0	1.1(-8)	4.0
256	3.0(-9)	4.0	3.0(-9)	4.0	3.0(-9)	4.0	3.0(-9)	4.0	6.7(-10)	4.1
f_3										
32	8.8(-4)		8.8(-4)		8.8(-4)		8.8(-4)		3.7(-4)	
64	6.0(-5)	3.9	6.0(-5)	3.9	6.0(-5)	3.9	6.0(-5)	3.9	1.7(-5)	4.5
128	3.9(-6)	4.0	3.9(-6)	4.0	3.9(-6)	4.0	3.9(-6)	4.0	9.2(-7)	4.1
256	2.4(-7)	4.0	2.4(-7)	4.0	2.4(-7)	4.0	2.4(-7)	4.0	5.5(-8)	4.1

Table 3 Maximum absolute errors and numerical convergence orders

We observe that the best performances are achieved by Q^{**} , while the behaviour of the other four operators is similar. Moreover for Q_1 , \bar{Q}_1 and Q_2 only data points inside or on the boundary of the domain are required.

Comparing the three operators proposed in this paper, if we look at the results obtained with the function f_1 , we can notice that they are comparable and the best ones are achieved by Q_2 .

6.2 Approximation of gradients

For each test function, using the same uniform rectangular grid G , we also compute the maximum absolute error $\nabla Ef = \max_{(u,v) \in G} \left(\left| \frac{\partial}{\partial x} f(u,v) - \frac{\partial}{\partial x} Qf(u,v) \right| + \left| \frac{\partial}{\partial y} f(u,v) - \frac{\partial}{\partial y} Qf(u,v) \right| \right)$, $Q = Q_1, \bar{Q}_1, Q_2, Q^*, Q^{**}$, for increasing values of m_1 and m_2 , and the logarithm of the ratio between two consecutive errors, denoted by ∇rf , see Table 4.

m_1 = m_2	Q_1		\bar{Q}_1		Q_2		Q^*		Q^{**}	
	∇Ef	∇rf	∇Ef	∇rf	∇Ef	∇rf	∇Ef	∇rf	∇Ef	∇rf
f_1										
32	4.2(-2)		1.2(-2)		1.7(-3)		1.7(-3)		1.0(-3)	
64	5.2(-3)	3.0	1.5(-3)	3.0	2.1(-4)	3.0	2.1(-4)	3.0	1.3(-4)	3.0
128	6.6(-4)	3.0	1.8(-4)	3.0	2.6(-5)	3.0	2.6(-5)	3.0	1.6(-5)	3.0
256	8.3(-5)	3.0	2.3(-5)	3.0	3.3(-6)	3.0	3.3(-6)	3.0	2.0(-6)	3.0
f_2										
32	5.9(-4)		5.9(-4)		2.8(-4)		2.8(-4)		2.0(-4)	
64	6.2(-5)	3.2	6.2(-5)	3.2	3.5(-5)	3.0	3.5(-5)	3.0	2.5(-5)	3.0
128	7.6(-6)	3.0	7.6(-6)	3.0	4.0(-6)	3.1	4.0(-6)	3.1	2.9(-6)	3.1
256	9.6(-7)	3.0	9.6(-7)	3.0	5.4(-7)	2.9	5.4(-7)	2.9	3.8(-7)	2.9
f_3										
32	8.9(-2)		8.9(-2)		4.5(-2)		4.5(-2)		3.5(-2)	
64	8.9(-3)	3.3	8.9(-3)	3.3	5.4(-3)	3.0	5.4(-3)	3.0	4.0(-3)	3.1
128	9.0(-4)	3.3	9.0(-4)	3.3	6.8(-4)	3.0	6.8(-4)	3.0	4.9(-4)	3.0
256	9.8(-5)	3.2	9.8(-5)	3.2	8.6(-5)	3.0	8.6(-5)	3.0	6.1(-5)	3.0

Table 4 Maximum gradient errors and numerical convergence orders

Also for the approximation of the gradient the same comments given in Section 6.2 on the performances of the proposed operators are valid.

If we evaluate the error at the points where superconvergence holds for the gradient, we observe that with the operators Q_2 , Q^* and Q^{**} the error is $O(h^4)$, see Table 5. Furthermore, since f_1 is a polynomial of degree four, the operators Q_2 , Q^* and Q^{**} interpolate the function f_1 at the points $A_{k,l}$, $M_{k,l}$, $C_{k,l}$ or $D_{k,l}$.

7 Final remarks

In this paper we have defined and analysed C^2 cubic discrete quasi-interpolants, constructing their coefficient functionals in several ways, comparing them and giving norm and error estimates. Interesting applications for these quasi-interpolants are in the second stage of the two-stage methods (see e.g. [10, 22]) or in the approximation of critical points and curvatures of a surface (see e.g. [13] for quadratic splines).

Acknowledgements The author is grateful to Prof. C. Dagnino and Prof. P. Sablonnière for helpful discussions and comments. The author also thanks the referees for their useful suggestions and remarks which improved this paper.

m_1 = m_2	Q_1		\bar{Q}_1		Q_2		Q^*		Q^{**}	
	∇Ef	∇rf	∇Ef	∇rf	∇Ef	∇rf	∇Ef	∇rf	∇Ef	∇rf
f_1										
32	4.2(-2)		1.2(-2)		2.8(-13)		2.3(-13)		2.3(-13)	
64	5.3(-3)	3.0	1.5(-3)	3.0	5.7(-13)	–	4.5(-13)	–	4.7(-13)	–
128	6.6(-4)	3.0	1.8(-4)	3.0	1.3(-12)	–	9.7(-13)	–	9.9(-13)	–
256	8.3(-5)	3.0	2.3(-5)	3.0	2.3(-12)	–	1.9(-12)	–	1.9(-12)	–
f_2										
32	5.9(-4)		5.9(-4)		8.9(-5)		6.4(-5)		2.2(-5)	
64	6.2(-5)	3.2	6.2(-5)	3.2	4.7(-6)	4.2	4.0(-6)	4.0	1.3(-6)	4.1
128	7.6(-6)	3.0	7.6(-6)	3.0	2.7(-7)	4.1	2.5(-7)	4.0	7.9(-8)	4.0
256	9.6(-7)	3.0	9.6(-7)	3.0	1.6(-8)	4.1	1.6(-8)	4.0	4.9(-9)	4.0
f_3										
32	8.9(-2)		8.9(-2)		3.4(-2)		3.4(-2)		1.7(-2)	
64	8.9(-3)	3.3	8.9(-3)	3.3	2.4(-3)	3.8	2.4(-3)	3.8	8.9(-4)	4.3
128	9.0(-4)	3.3	9.0(-4)	3.3	1.6(-4)	3.9	1.6(-4)	3.9	5.1(-5)	4.1
256	9.8(-5)	3.2	9.8(-5)	3.2	9.8(-6)	4.0	9.8(-6)	4.0	3.1(-6)	4.0

Table 5 Maximum gradient errors at specific points (Section 4) and numerical convergence orders

References

- Barrera, D., Ibáñez, M.J., Sablonnière, P.: Near-best discrete quasi-interpolants on uniform and nonuniform partitions. In: Cohen, A., Merrien, J.L., Schumaker, L.L. (eds.) *Curve and Surface Fitting, Saint-Malo 2002* pp. 31–40. Nashboro Press, Brentwood (2003)
- Barrera, D., Ibáñez, M.J., Sablonnière, P., Sbibih, D.: Near-best quasi-interpolants associated with H -splines on a three-direction mesh, *J. Comput. Appl. Math.* 183, 133–152 (2005)
- Barrera, D., Ibáñez, M.J., Sablonnière, P., Sbibih, D.: On near-best discrete quasi-interpolation on a four-directional mesh, *J. Comput. Appl. Math.* (2009) doi : 10.1016/j.cam.2009.02.063
- Barrera, D., Ibáñez, M.J.: Bernstein-Bézier representation and near-minimally normed discrete quasi-interpolation operators. *Appl. Num. Math.* 58, 59–68 (2008)
- Bettayeb, A.: Multi-box splines: analysis and examples, PhD Thesis, University of Dundee, (2008)
- Chui, C.K., Jiang, Q.: Surface subdivision schemes generated by refinable bivariate spline function vectors, *Appl. Comput. Harm. Anal.* 15, 147–162 (2003)
- Chui, C.K., Jiang, Q.: Matrix-valued subdivision schemes for generating surfaces with extraordinary vertices, *Comput. Aided Geom. Design* 23, 419–438 (2006)
- Dagnino, C., Lamberti, P.: On C^1 quasi interpolating splines with type-2 triangulations. Progetto MURST "Analisi Numerica: Metodi e Software Matematico", Ferrara, 2000
- Dagnino, C., Lamberti, P.: SPLISURF for use with Matlab. <http://web.unife.it/utenti/valeria.ruggiero/AnNum97/index2.html> (2000)
- Davydov, O., Zeilfelder, F.: Scattered data fitting by direct extension of local polynomials to bivariate splines. *Adv. Comput. Math.* 21, 223–271 (2004)
- Davydov, O., Sablonnière, P.: C^2 piecewise cubic quasi-interpolants on a 6-direction mesh. *J. Approx. Theory* 162, 528–544 (2010)
- Franke, F.: Scattered data interpolation: Tests of some methods. *Math. Comp.* 38, 181–200 (1982)
- Foucher, F., Sablonnière, P.: Approximating partial derivatives of first and second order by quadratic spline quasi-interpolants on uniform meshes. *Math. & Computers in Simulation* 77, 202–208 (2008)
- Goodman, T.N.T.: Constructing pairs of refinable bivariate spline functions. In: Le Méhauté, A., Rabut, C., Schumaker, L.L. (eds.) *Surface Fitting and Multiresolution Methods*, pp.145–162. Vanderbilt University Press, Nashville, TN (1997)
- Goodman, T.N.T.: Properties of bivariate refinable spline pairs. In: Haussmann, W., Jetter, K., Reimer, M. (eds.) *Multivariate Approximation, Recent Trends and Results*, pp. 63–82. Akademie Verlag, Berlin (1997)

-
16. Goodman, T.N.T.: Multi-box splines, *Constr. Approx.* 25, 279–301 (2007)
 17. Ibáñez Pérez, M.J.: Quasi-interpolantes spline discretos de norma casi mínima. Teoría y aplicaciones. PhD Thesis, Universidad de Granada, (2003)
 18. Lai, M.J., Schumaker, L.L.: Spline functions on triangulations. Cambridge University Press (2007).
 19. Remogna, S.: Constructing good coefficient functionals for bivariate C^1 quadratic spline quasi-interpolants. In: M. Daehlen et al. (eds.) *Mathematical Methods for Curves and Surfaces*, LNCS 5862, pp. 329–346. Springer-Verlag, Berlin Heidelberg (2010)
 20. Remogna, S.: Local spline quasi-interpolants on bounded domains of \mathbb{R}^2 and \mathbb{R}^3 , PhD Thesis, Università degli Studi di Torino - Université de Rennes 1, (2010)
 21. Sablonnière, P.: Recent progress on univariate and multivariate polynomial and spline quasi-interpolants. In: de Bruijn, M.G., Mache, D.H., Szabados, J. (eds.) *Trends and Applications in Constructive Approximation*, ISNM 151, pp. 229–245 (2005)
 22. Schumaker, L.L.: Two-stage spline methods for fitting surfaces. In: Schaback, R., Scherer, K. (eds.) *Approximation Theory*, LNM 556, pp. 378–389. Springer-Verlag, Berlin (1976)
 23. Watson, G.A.: *Approximation Theory and Numerical Methods*. John Wiley & Sons, Ltd., Chichester (1980)