

AperTO - Archivio Istituzionale Open Access dell'Università di Torino

Ecofriendly in-line process monitoring: a case study. Anthracene photodegradation in the presence of refuse-derived soluble bio-organics

This is the author's manuscript

Original Citation:

Availability:

This version is available <http://hdl.handle.net/2318/102303> since 2016-10-04T12:38:40Z

Published version:

DOI:10.1007/s00216-012-5961-3

Terms of use:

Open Access

Anyone can freely access the full text of works made available as "Open Access". Works made available under a Creative Commons license can be used according to the terms and conditions of said license. Use of all other works requires consent of the right holder (author or publisher) if not exempted from copyright protection by the applicable law.

(Article begins on next page)



UNIVERSITÀ DEGLI STUDI DI TORINO

This is an author version of the contribution published on:

Questa è la versione dell'autore dell'opera:

[Analytical and Bioanalytical

Chemistry, 404 (3), 2012, 10.1007/s00216-012-5961-3]

The definitive version is available at:

La versione definitiva è disponibile alla URL:

[<http://www.springer.com/chemistry/analytical+chemistry/journal/21>

6]

Ecofriendly in-line process monitoring. A case study: Anthracene photodegradation in the presence of refuse derived soluble bio-organics.

A. Bianco Prevot^{*1}, P. Avetta¹, D. Fabbri¹, E. Montoneri¹, A. Morales-Rubio², M. de la Guardia²

*alessandra.biancoprevot@unito.it

¹*Dipartimento di Chimica, Via Giuria 7 – 10125 Torino (Italy)*

²*Departamento de Química Analítica, Universitat de Valencia, 50 Dr. Moliner Str., 46100, Burjassot, Valencia (Spain)*

Abstract

The photodegradation of anthracene has been studied in aqueous solutions containing soluble bio-organic substances isolated from urban refuses. To perform a preliminary rapid feasibility study of this process, while reducing the amount of analytical effort and reagents, an experimental set-up was developed. This consists in a Teflon coil surrounding a UV-lamp and coupled with an in-line spectrofluorimeter. In this fashion only few milliliters of solution are needed to study the degradation process. Furthermore, the in-line spectroscopic approach allows to monitor the process without reagents consumption. Additional studies by liquid chromatography and toxicity tests clearly indicated that the apparent inhibition effect of bio-organic compounds on anthracene degradation is not relevant. The results imply that urban refuses may be used as auxiliaries in the recovery of polycyclic aromatic hydrocarbons from contaminated soil by washing, without deleterious effects on the photodegradation of anthracene and other aromatic pollutants.

Keywords

Anthracene degradation, soluble bio-organics, green analytical chemistry, in-line monitoring

Introduction

Process monitoring usually requires performing a big number of runs which include sampling and off-line analyses. However, in preliminary phases, a fast screening procedure would be desirable in order to obtain in a short time significant information to be used for designing the specific trials, while reducing

the amount of analytical effort and reagents. In general, screening methods tend to be qualitative, involving little or no sample treatment, and the response is used for immediate decision-making, with confirmation requiring a conventional alternative. The present paper reports a green analytical approach [1] applied to a case study. This consisted in a process for testing the capacity of refuse derived water soluble bio-organics (SBO) to perform light-induced degradation of polycyclic aromatic hydrocarbons (PAH) as photosensitizers. Indeed, SBO isolated from urban biowastes (UBW) of different composition and aging conditions have been reported to enhance the photodegradation rate of a number of potential organic pollutants, such as organic azo-dyes [2], phenols [3], and pesticides [4], present in many industrial effluents. The interest in using SBO for the PAH photodegradation stemmed from other work [5] reporting that SBO is also an efficient surfactant to use for environmental remediation of PAH contaminated sites. These data therefore prospected the use of the same substance to remove pollutants by soil washing and successively to promote cleaning out of the recovered aqueous waste by photolysis. The hereinafter reported analytical set up for the above case study investigation comprises a miniaturized continuous irradiation system equipped with a sample circulation loop, coupled with an in-line fluorimetric detector. This system requires very small amount of testing solution, no additional analytical reagents or solvents, and at the same time allows a high number of rapid measurements.

Experimental

Materials

Anthracene from Fluka (Buchs, Switzerland), NaOH and CH₃CN from Scharlau (Barcelona, Spain) were used as received.

Four SBO, namely FORSUD, CVDT110, CVDFT110 and CVT365, were collected from different biowastes, aged for different time under non aerobic or aerobic digestion which were obtained from Acea Pinerolese waste treatment plant in Pinerolo (Italy). The SBO were isolated in a pilot plant located in Rivarolo Canavese, Italy [6] and characterized by data reported in Table 1 as previously indicated [7]. The refuse materials were supplied MilliQTM water was used throughout the work.

Integrated irradiation-analytical set up

According to Figure 1 scheme, the sample solution is circulated using a peristaltic pump from the sample reservoir through a Teflon coil surrounding the cylindrical UV lamp, to the fluorimeter cell located inside the fluorescence spectrometer cavity, and back to the sample reservoir. The UV lamp was used to irradiate the sample solutions, and therefore to induce the photodegradation of the solute in the test solution, while the fluorimeter cell was used to monitor the whole fluorescent emission abatement, thus allowing to evaluate the advancement of the photodegradation reaction as a function of time. A Perkin Elmer LS 50 luminescence spectrometer was employed; the emission and excitation slits width were set at 5 nm and a 200 nm min⁻¹ scan speed was used. Three UV-lamps

Vilberb Lourmat of 220 volts and 50 Hertz were used in turn, respectively emitting at 254 nm, 312 nm and 350 nm.

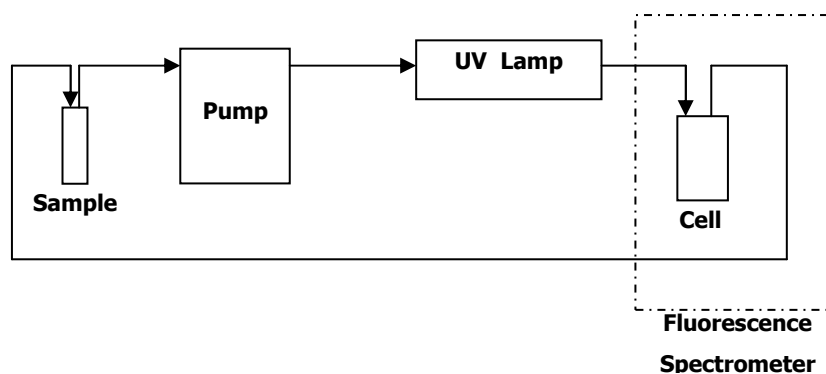

Fig. 1 Scheme of the integrated irradiation-analytical set-up employed for photodegradation of anthracene in the presence of SBO

All degradation experiments were run in triplicate. Data are reported as average values. Calculated relative standard deviation was 3.5-5.0 %.

SBO solubilization procedure

The following procedure was adopted to prepare SBO solutions. After the addition of Milli-QTM water to solid SBO, the resulting aqueous suspension was stirred and sonicated. Then the SBO suspension was centrifuged three times at 3500 rpm for 10 minutes. The supernatant solution was separated and filtered through a cellulose acetate 0.45 μm pore diameters filter (Millipore) to remove residual insoluble matter. The resulting solution was kept frozen at $-10\text{ }^{\circ}\text{C}$ before use.

HPLC analysis

The degradation of anthracene was followed by HPLC, employing an Agilent Technologies 1100 Series instrument, equipped with Lichrospher PAHs column 250 mm x 4 mm i.d., d.p. 4 μm from Merck (Darmstadt, Germany). Anthracene was eluted in isocratic conditions, employing water (30 % V/V) and acetonitrile (70 % V/V) as eluent. The flow rate was 1.0 mL min⁻¹. A fluorescence detector was used; the excitation wavelength was fixed at 250 nm and the emission wavelength at 402 nm.

Results and discussion

As in previous work [7], the four SBO sourced from different biowastes (see Materials section) were characterized by their ash, C and N content, and by their lipophilic/hydrophilic (LH) C ratio (see Table 1).

Table 1 Characteristics of the SBO employed through this study

<i>SBO acronym</i>	<i>Starting organic fraction of urban waste</i>	<i>Ash</i>	<i>C</i>	<i>N</i>	<i>LH</i>
--------------------	---	------------	----------	----------	-----------

	<i>and treatment</i>	(%)	(%)	(%)	
FORSUD	Organic fraction of municipal solid wastes after 15 days of anaerobic digestion - Extracted with NaOH	20.2	35.7	4.66	9.27
CVDT110	Green wastes and FORSUD composted for 110 days - Extracted with KOH	27.3	35.7	4.41	5.23
CVDFT110	Green wastes, FORSUD and sludge composted for 110 days - Extracted with NaOH	30.2	38.4	4.61	5.34
CVT365	Green wastes composted for 365 days - Extracted with NaOH	53.7	30.7	3.71	4.00

Note: Ash, C and N content, LH (liphophilic/hydrophilic ratio).

Optimization of instrumental fluorescence parameters

In order to optimize the detection parameters, preliminary test were performed on 1 mg L^{-1} of anthracene aqueous solution. Fluorescence spectra were recorded in the emission wavelength (λ_{em}) range from 250 to 600 nm, under a continuous variation of the excitation wavelength (λ_{ex}) in the range from 264 to 500 nm. From the resulting tri-dimensional plot it was obtained the contour plot reported in Figure 2. As can be observed, two areas are present with highest signal intensity, the first one in the λ_{ex} range from 350 to 400 nm and the second one at λ_{ex} lower than 264 nm. Further spectra were therefore recorded limiting the λ_{ex} to the two areas of interest and, for anthracene analyses, it was established, a λ_{em} range from 250 to 500 nm for a fixed λ_{ex} at 250 nm being monitored the degradation process by following the fluorescence intensity evolution at a wavelength corresponding to the maximum ($\lambda_{em} = 402 \text{ nm}$). Figure 3 shows a typical anthracene fluorescence spectrum obtained at a concentration of 0.5 mg L^{-1} .

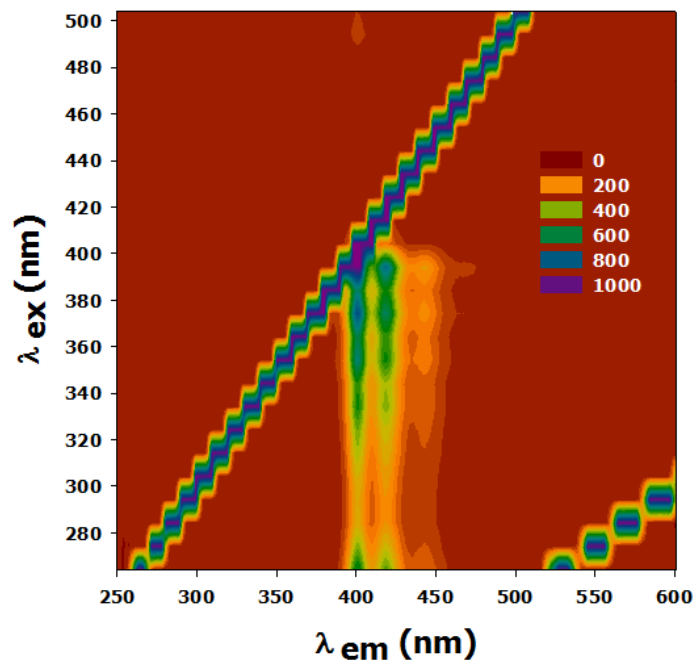

Fig. 2 Contour plot of the excitation and emission fluorescence spectra of anthracene. 1 mg L⁻¹ anthracene solution, Starting $\lambda_{\text{ex}} = 264$ nm, λ_{ex} increment = 10 nm, Number of scans = 25

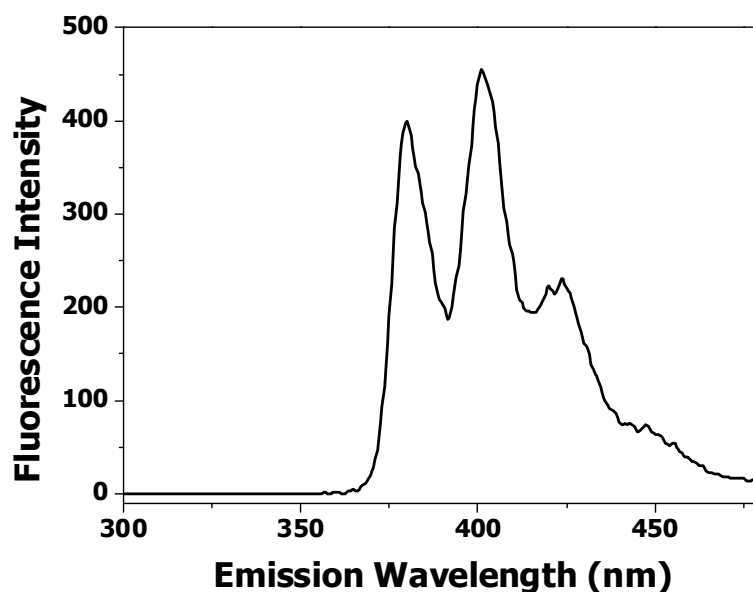

Fig. 3 Fluorescence spectrum of an aqueous solution of anthracene 0.5 mg L⁻¹ obtained upon excitation at 250 nm

Before performing irradiation studies, the effect of SBO on the anthracene fluorescence emission was checked by recording the spectrum of a solution containing SBO and anthracene at a concentration of 200 mg L⁻¹ and 1 mg L⁻¹ respectively. In the presence of any of the examined SBO a quenching phenomenon occurred and a decrease of anthracene fluorescence signal was observed compared to the signal recorded in pure water solution. Moreover the

whole spectrum, both the number and the relative intensity of the peaks, appeared rather modified by the presence of added SBO. Since it cannot be excluded a priori that SBO themselves undergo degradation, their quenching effect could vary during the irradiation. This fact would make more difficult the quantitative evaluation of anthracene abatement. Under these circumstances, two solutions containing the same amounts of CVDT110 were prepared, and one was irradiated for two hours. Afterwards, 1 mg L^{-1} anthracene was added to both solutions and their fluorescence was measured. The two signals did not show any difference, thus allowing to consider the SBO quenching effect as constant during the irradiation. The possible thermal degradation due to lamp heating was also excluded, since only a slight increase of about $3 \text{ }^{\circ}\text{C}$ after 90 minutes irradiation was observed.

Anthracene photodegradation

Anthracene irradiation experiments were performed in the presence of one SBO at a time, and results were compared with those obtained irradiating a pure anthracene aqueous solution of the same concentration.

In the following plots (Figures 4-6) the abatement percentage of the fluorescence intensity, vs. the irradiation time are reported for irradiations performed with three different monochromatic light sources emitting at 254 nm, 312 nm and 350 nm, respectively.

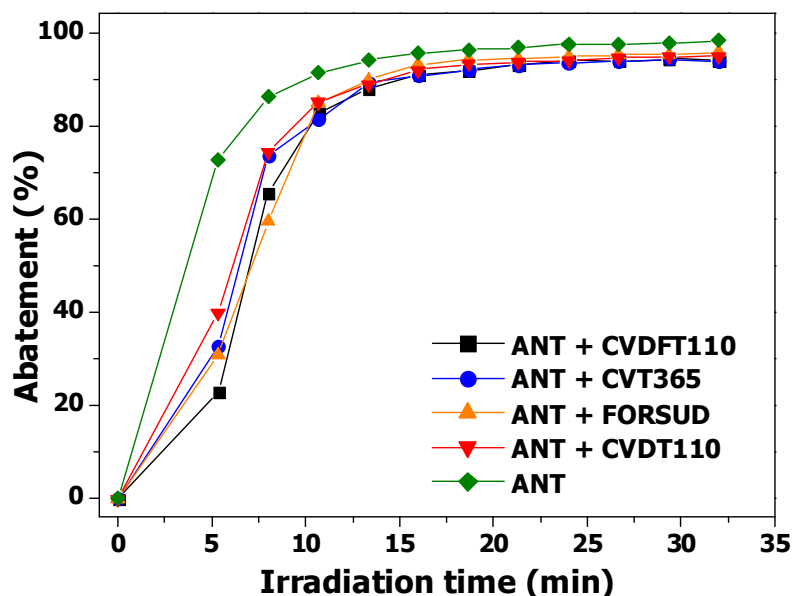

Fig. 4 Fluorescence abatement percentage of a solution of anthracene (ANT) (1 mg L^{-1}) containing different SBO (200 mg L^{-1}) vs. irradiation time ($\lambda_{\text{ex}} = 250 \text{ nm}$, $\lambda_{\text{em}} = 402 \text{ nm}$). Irradiation performed with monochromatic light at 254 nm

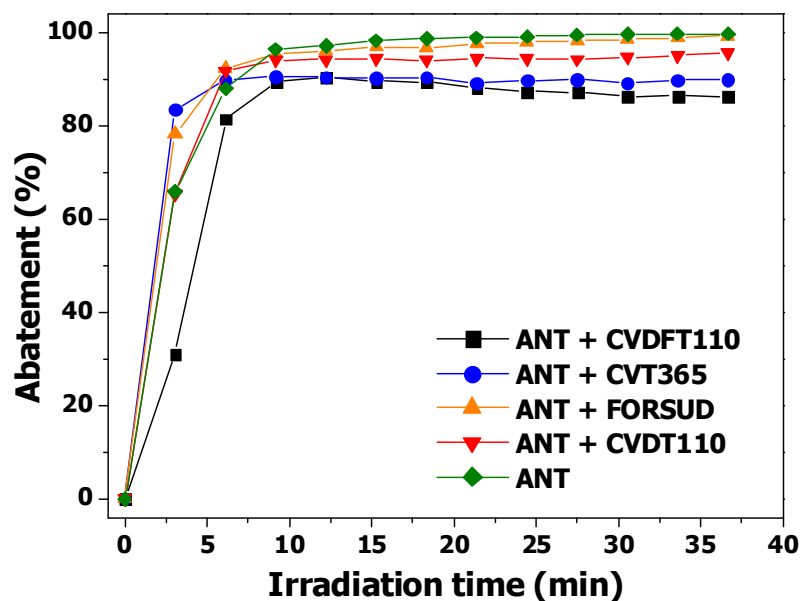

Fig. 5 Fluorescence abatement percentage of a solution of anthracene (ANT) (1 mg L^{-1}) containing different SBO (200 mg L^{-1}) vs. irradiation time ($\lambda_{\text{ex}} = 250 \text{ nm}$, $\lambda_{\text{em}} = 402 \text{ nm}$). Irradiation performed with monochromatic light at 312 nm

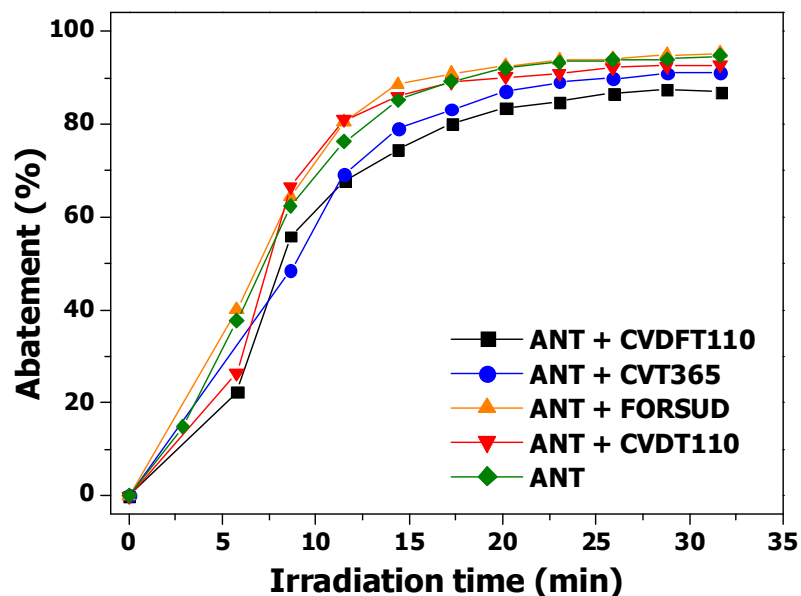

Fig. 6 Fluorescence abatement percentage of a solution of anthracene (ANT) (1 mg L^{-1}) containing different SBO (200 mg L^{-1}) vs. irradiation time ($\lambda_{\text{ex}} = 250 \text{ nm}$, $\lambda_{\text{em}} = 402 \text{ nm}$). Irradiation performed with monochromatic light at 350 nm

It may be clearly observed that using all the considered irradiation wavelengths, anthracene undergoes direct photolysis in the presence of SBO and complete fluorescence abatement occurs when the irradiation is performed at 254 or 312 nm, whereas about 90 % of abatement seems to occur when irradiating at 350 nm. In the presence of SBO different effects can be observed depending on the irradiation source. Figure 4 shows that when the irradiation is performed at 254

nm, the degradation process is initially slowed down by the presence of SBO, but ultimately almost 100 % of fluorescence abatement can be achieved at the same time as for the photolytic degradation in the absence of SBO. This behavior was the same for all investigated SBO. On the contrary, Figures 5 and 6 show that when irradiating at 312 and 350 nm respectively, only CVDFT110 and CVT365 seem to delay the degradation process whereas the other SBO do not significantly modify the degradation kinetic compared to that observed in their absence. This behaviour cannot be easily rationalized because of the concomitant phenomena occurring during irradiation. Actually, anthracene absorbs the radiation and undergoes photolysis. At the same time also SBO absorb radiation, in competition with anthracene, and can produce reactive species able to promote the degradation of anthracene. In this fashion, the inhibition effect exerted on the anthracene direct photolysis would be compensated. Nevertheless, also the photodegradation of the SBO can occur and this process can consume reactive species [8-10]. Therefore, it can be assumed that the degradation kinetics of anthracene in the presence of SBO are the result of a balance between possible beneficial and detrimental effects of SBO light absorption.

The inhibiting effect of SBO is directly related to its concentration as it appears in Figure 7, which shows the results obtained by irradiating anthracene at 312 nm in the presence of CVDFT110 in a concentration range from 5 to 200 mg L⁻¹.

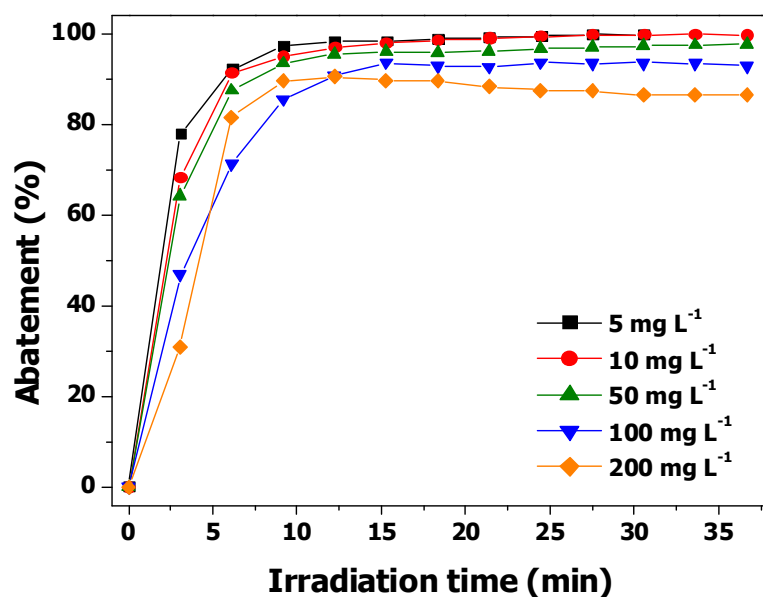

Fig. 7 Fluorescence abatement percentage of anthracene solution (1 mg L⁻¹) vs. irradiation time. Experiments performed in the presence of CVDFT110 at different concentrations. Irradiation performed with monochromatic light at 312 nm. Detector parameters; $\lambda_{ex} = 250$ nm, $\lambda_{em} = 402$ nm.

The degradation rate of anthracene increases with the decrease of SBO concentration. Nevertheless, at least 200 mg L⁻¹ of added SBO might be considered, in view of coupling the photodegradation process with a previous soil washing treatment, in order to obtain good yields in the desorption process of pollutants from the soil.

Even if the kinetic of fluorescence abatement has been considered as representative of anthracene degradation kinetic, it is clear that this is a simplification, since probably formed intermediate compounds, emitting in the same experimental conditions, would affect the signal. For this reason further investigations on anthracene degradation in the presence of the above mentioned SBO were performed using traditional devices as the Solarbox, Co.Fo.Megra (Milan, Italy) equipped with a Xe-lamp and a cut-off filter below 400 nm; 5 mL of solution containing only pure anthracene (1 mg L^{-1}) and anthracene (1 mg L^{-1}) with CVDT110 (200 mg L^{-1}) were irradiated at different irradiation times. A traditional off-line spectrophotometric analysis was performed by recording the fluorescence emission at 402 nm, in order to assess the kinetic of the degradation process.

The degradation process was also monitored by means of HPLC with fluorescence detection, in order to evaluate the evolution of anthracene separately from the formed intermediates.

Data reported in Figure 8a evidence that, when the process is monitored by analysing the global solution fluorescence, anthracene abatement is underestimated. The results obtained by HPLC analysis show indeed higher abatement percentages than the one calculated on the basis of spectrometric data. After 45 minutes irradiation, an anthracene abatement of about 90 % was reached, whereas, only about 40 % of the global fluorescence abatement was attained (see Figure 8b). A possible explanation could be the formation of anthracene and CVDT110 fluorescent degradation products, that would contribute to the fluorescence of the whole solution. Other workers have indeed reported the light induced formation of several anthracene oxidation products containing hydroxyl, aldehyde and keto groups [11,12]. Thus, in the present case, the decrease of fluorescence due to the abatement of anthracene would be compensated by the increase of fluorescence due to the degradation products. Figure 9 reports the chromatograms obtained by analyzing solution of anthracene in the presence of CVDT110, before and after irradiation; the appearance of a new peak having a retention time $t_R=3.95 \text{ min}$ in the chromatogram corresponding to the irradiated solution, confirms indeed the formation of some fluorescent intermediate. Nevertheless, the peak intensity contributed by this intermediate cannot account for the % abatement values reported in Fig. 8a. It should therefore be considered the presence of other intermediates. Optimization of the HPLC conditions to identify such compounds was however out of the scope of the present work. Under an applicative point of view, the chromatographic results completed the proposed in-line monitoring approach making it as preliminary fast and environmental friendly screening tool.

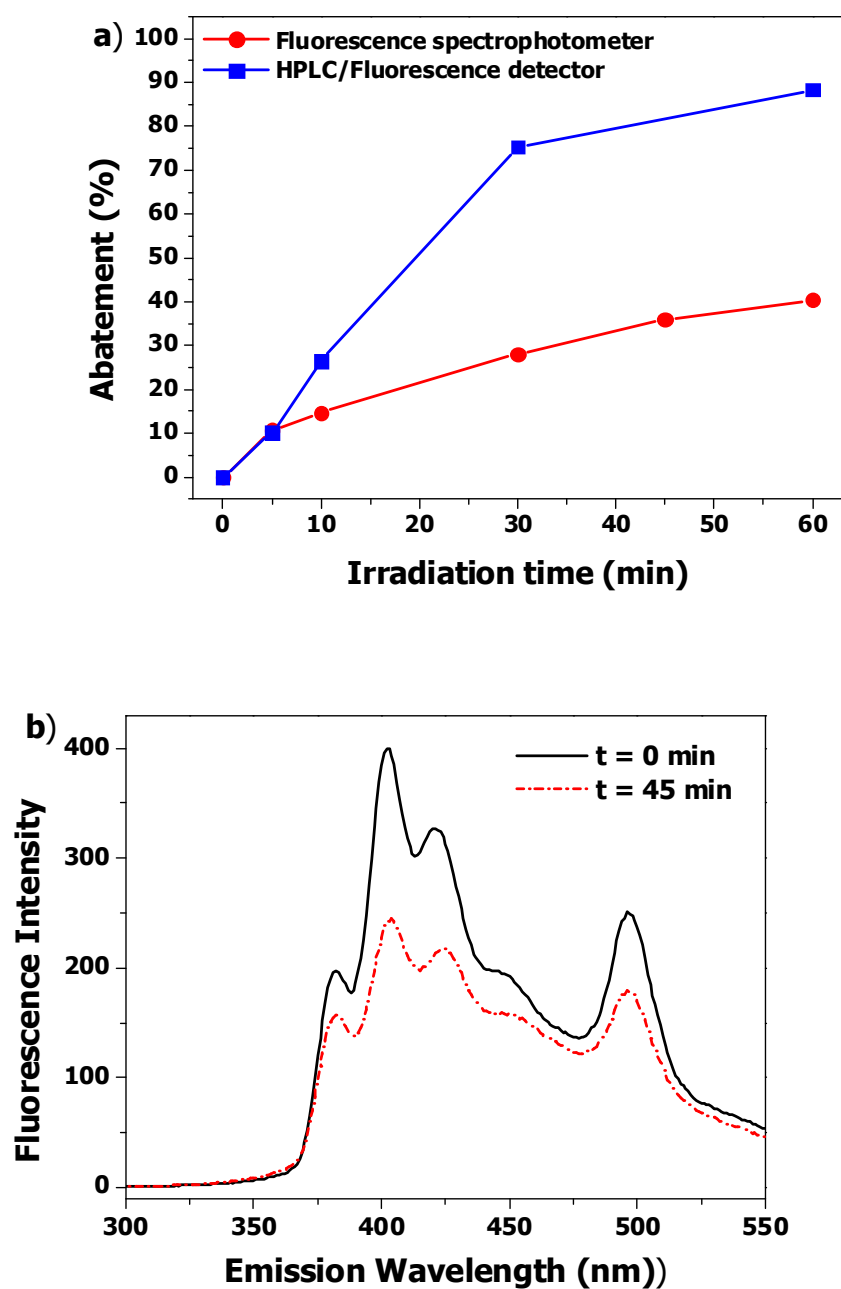

Fig. 8 a) Fluorescence abatement percentage of an anthracene solution vs. irradiation time ($\lambda_{\text{ex}} = 250 \text{ nm}$, $\lambda_{\text{em}} = 402 \text{ nm}$). Initial concentration: 1 mg L^{-1} anthracene and 200 mg L^{-1} CVDT110. Irradiation performed in Solarbox (cut-off filter 400 nm).

b) Effect of irradiation on the fluorescence spectrum of anthracene solution containing added CVDT110 ($\lambda_{\text{ex}} = 250 \text{ nm}$)

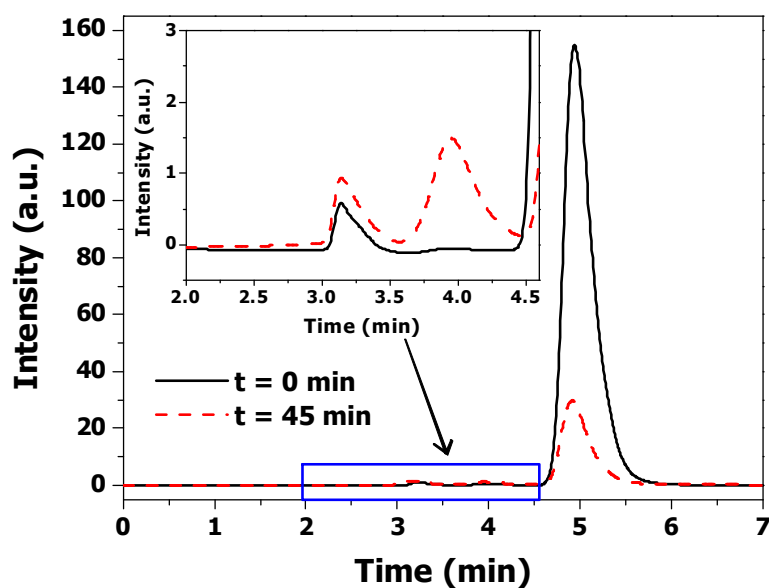

Fig. 9 Effect of irradiation on the chromatograms of anthracene solution containing added CVDT110 ($\lambda_{\text{ex}} = 250 \text{ nm}$, $\lambda_{\text{em}} = 402 \text{ nm}$). Initial concentration: 1 mg L^{-1} anthracene and 200 mg L^{-1} CVDT110. Irradiation performed in Solarbox (cut-off filter 400 nm)

Effect of additives on anthracene degradation kinetic

Since the addition of SBO did not enhance the anthracene photodegradation, the effect of other photoactive substances was checked. H_2O_2 (0.01 M) was chosen since it allowed to work in homogeneous system and it is well known that its photolysis under UV irradiation yields the formation of highly reactive $\bullet\text{OH}$ radicals. Experiments were performed by irradiating in Solarbox aqueous anthracene solutions in the presence of CVDT110 and H_2O_2 . Figures 10a and 11 report the results obtained by monitoring the process by fluorescence spectrophotometry and HPLC with fluorescence detection respectively. As can be observed, the choice of the suitable detection approach is in this case crucial. Indeed, the whole fluorescence measurement apparently indicates that H_2O_2 inhibits anthracene abatement. On the contrary the opposite is evident through the HPLC measurements. One explanation could be that, under irradiation in the presence of added H_2O_2 , SBO undergoes phototransformation with consequent change of its quenching effect on anthracene fluorescence. To confirm this hypothesis, two solutions containing the same amounts of CVDT110 and H_2O_2 were prepared, and one was irradiated for 30 minutes. Afterwards, 1 mg L^{-1} anthracene was added to both solutions. The fluorescence spectra reported in Figure 10b show that the fluorescence of anthracene in the irradiated solution is significantly higher than that recorded in the non irradiated one. This effect obviously leads to overestimation of the residual anthracene content by measurement of the solution total fluorescence.

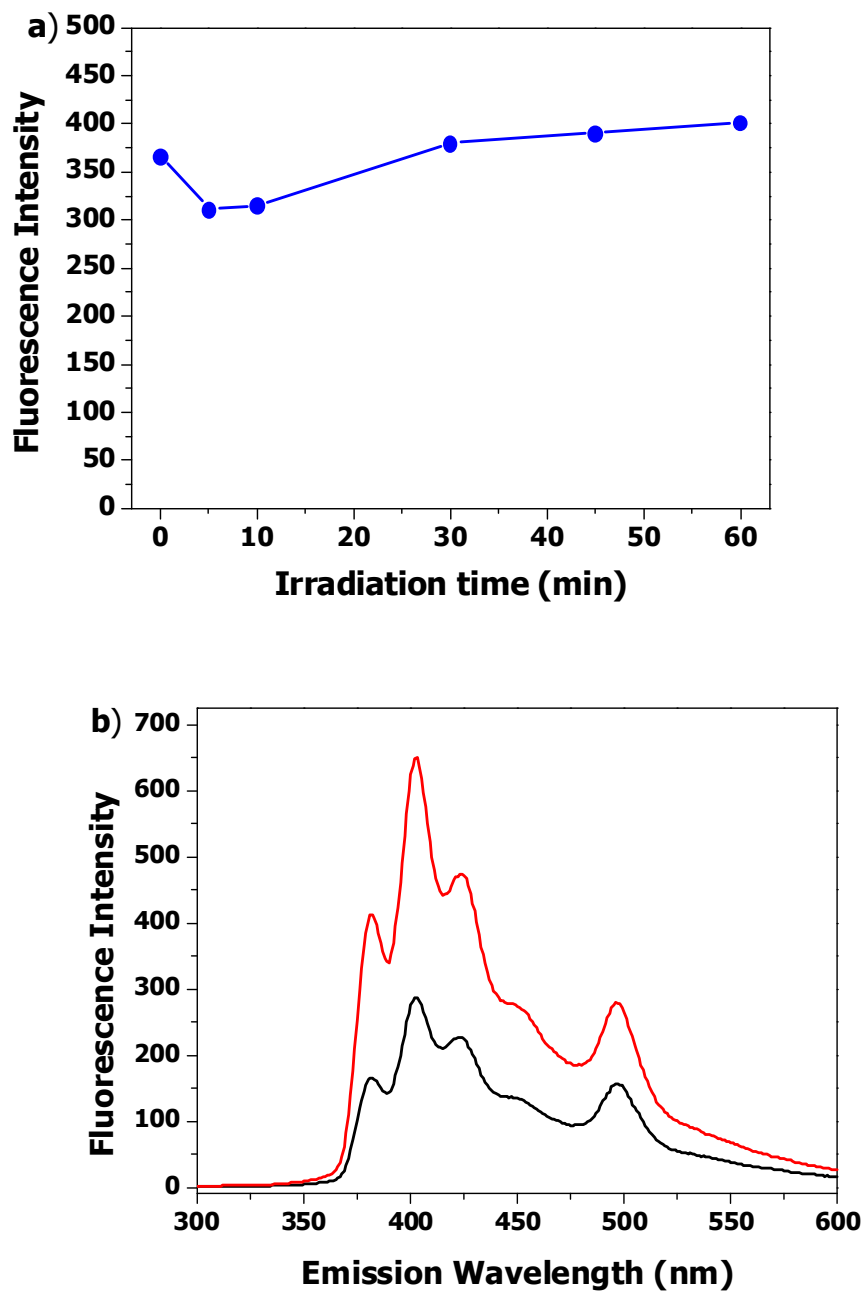

Fig. 10 a) Fluorescence intensity evolution of anthracene solution vs. irradiation time ($\lambda_{\text{ex}} = 250$ nm, $\lambda_{\text{em}} = 402$ nm); b) Fluorescence spectrum of non-irradiated aqueous solution of anthracene, CVDT110 and H_2O_2 (black line) and of aqueous solution of CVDT110 and H_2O_2 irradiated for 30 minutes (red line) and afterwards added with anthracene... Experimental conditions: 1 mg L^{-1} anthracene, 200 mg L^{-1} CVDT110 and $0.01 \text{ M H}_2\text{O}_2$. Irradiation performed in Solarbox (cut-off filter 400 nm)

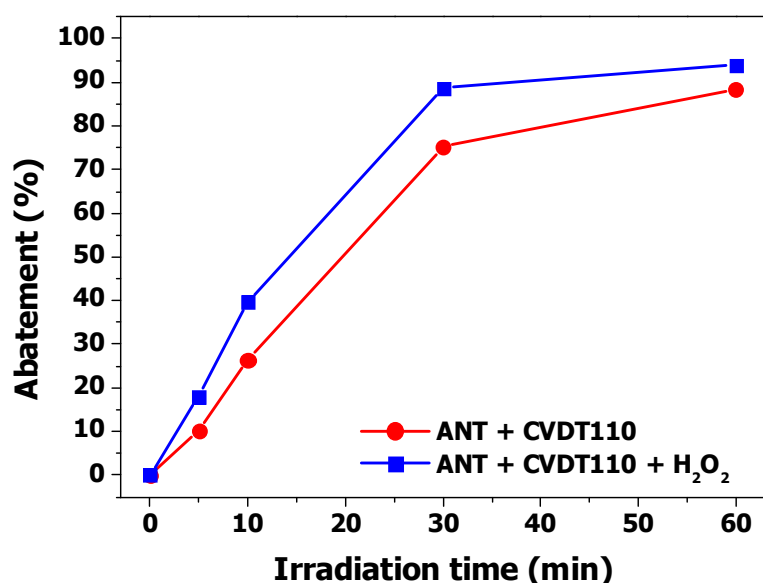

Fig. 11 Anthracene (ANT) percentage abatement determined by HPLC with fluorescence detector vs. irradiation time ($\lambda_{\text{ex}} = 250 \text{ nm}$, $\lambda_{\text{em}} = 402 \text{ nm}$). Initial concentration: 1 mg L^{-1} anthracene, 200 mg L^{-1} CVDT110 and $0.01 \text{ M H}_2\text{O}_2$. Irradiation performed in Solarbox (cut-off filter 400 nm)

The addition of H_2O_2 leads to an increase of the anthracene degradation kinetic (Figure 11), then a synergistic effect between the SBO and this other photoactive substance was observed.

Toxicity test

The final aim of a photodegradative process could be to completely mineralize the contaminants or at least to establish a treatment time suitable to eliminate or reduce the waste toxicity. In addition it is very important to evidence the eventual formation of intermediate products, possessing higher toxicity than the original molecules. Commonly the evaluation of the mineralization level is performed by total organic carbon (TOC) analysis. However, in the presence of SBO this type of analysis is very tricky since SBO itself contributes, in a large excess, to the organic C concentration. Also the identification of intermediate products is not straightforward, since, in the presence of SBO, also its degradation products must to be taken into account. A simpler approach to evaluate the treatment goodness in the presence of complex systems may be the evaluation of the global toxicity of the investigated solutions before and after irradiation.

In the present work, toxicity was evaluated by using the Microtox® test, which measures the inhibition of the natural bioluminescence (Effect (%)) of the *Vibrio Fischeri* bacteria due to the substrates in solution. This test is a powerful tool for screening the toxicity of a set of samples containing a multitude of chemical compounds.

To understand the significance of the experimental data, it must be known that an Effect (%) lower than 20 % corresponds to the absence of acute toxicity, whereas an effect in the range from 20 to 50 (%) corresponds to a weak toxicity.

Tests were performed on pure anthracene aqueous solutions (1 mg L^{-1}) and on solutions containing anthracene (1 mg L^{-1}) and CVDT110 (200 mg L^{-1}), irradiated in Solarbox (cut-off filter 400 nm) at different times.

In Figure 12, for pure anthracene, a slight increase of the Effect (%) was observed in the early hours of treatment, followed by a decrease of the inhibition effect up to -20 % after 1 h irradiation. Almost the same trend can be observed in Figure 13 for samples containing also SBO. However, in this case the curve seems to be shifted to lower Effect (%) values. In any case, fluctuations of Effect (%) in the range from -10 % to 10 % should not be considered significant, and thus, these results imply that no toxic compounds arise from the degradation of anthracene nor from the degradation of SBO itself thus confirming the goodness of the treatment also from this important point of view.

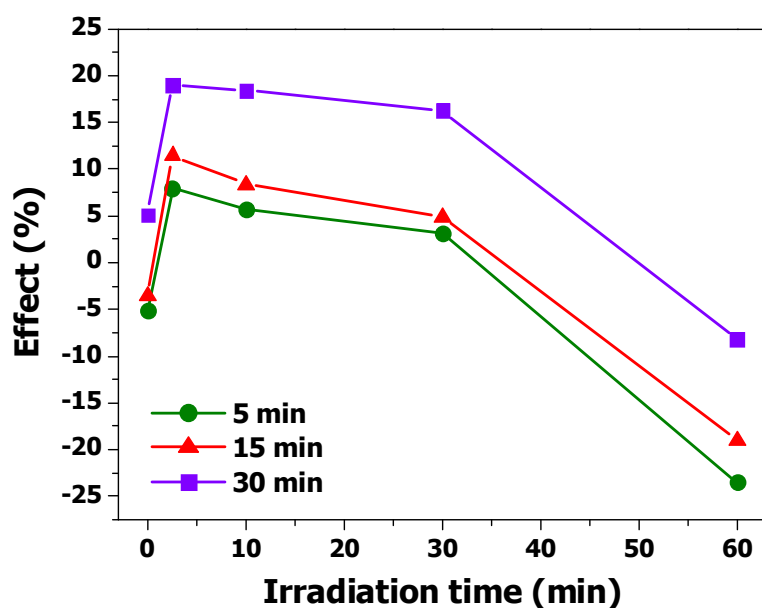

Fig. 12 Effect (%) measured in biotoxicity Microtox[®] test of anthracene solutions (1 mg L^{-1}) at different irradiation time (contact time = 5 - 15 - 30 min)

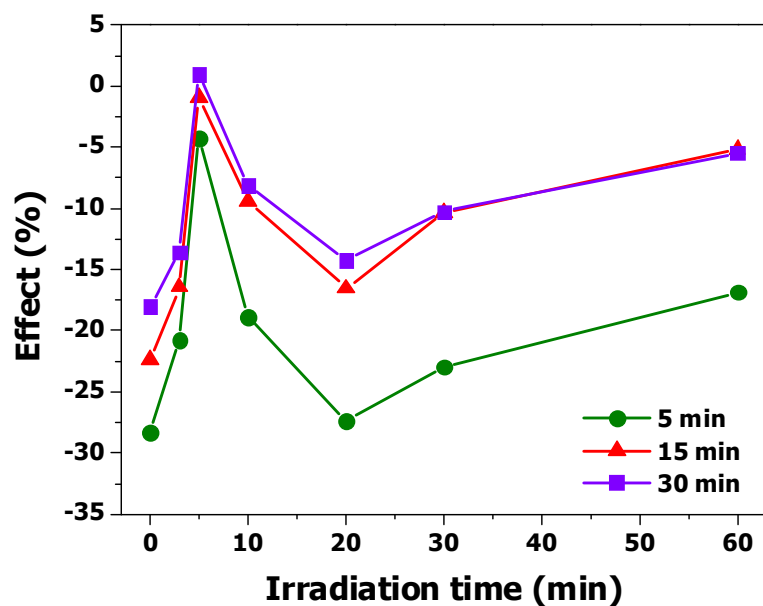

Fig. 13 Effect (%) measured in biotoxicity Microtox[®] test of anthracene (1 mg L^{-1}) irradiated in the presence of CVDT110 (200 mg L^{-1}) at different irradiation time (contact time = 5 - 15 - 30 min)

Conclusions

The obtained results evidenced that anthracene photodegradation is not negatively affected by the presence of SBO, thus allowing to envisage the use of SBO as additive in anthracene removal from contaminated soils. In any case even in the presence of SBO almost completely abatement of anthracene was achieved and, at all the considered wavelengths, no significant differences were observed among the four different SBO evaluated through this study. Moreover the addition of H_2O_2 leads to a synergistic effect, enhancing anthracene degradation.

The adopted experimental set-up evidenced the possibility to perform preliminary screening of photodegradation process efficiency, without produce any waste, since the examined solutions, at the end of the study were considered safe to be discarded, as confirmed by the toxicity tests. At the same time, the results obtained in the presence of added H_2O_2 underlined the need of an accurate knowledge of the system reactivity and of the matrix effect, in order to ensure that the results obtained by rapid and environmentally friendly approach are reliable with the evolution of the considered system. Additional HPLC analysis resulted to be mandatory to complete the in-line fluorescence screening studies when the matrix effect cannot be considered constant along the process.

Acknowledgements

This work was carried out at the start with Regione Piemonte Cipe 2006 funds within the Biochemenergy project. The authors are grateful to Acea Pinerolese Industriale in Pinerolo, TO (Italy) for supplying the biowastes and to Studio Chiono ed Associati in Rivarolo Canavese, TO (Italy) for making available the SBO production test facility.

The authors are also grateful to 7thFP IRSES-2010-269128-EnvironBos Marie Curie Action.

References

- [1] S. Armenta, S. Garrigues, M. de la Guardia, "Green Analytical Chemistry", *Trends in Analytical Chemistry*, **2008**, 27, 497-511.
- [2] A. Bianco Prevot, D. Fabbri, E. Pramauro, C. Baiocchi, C. Medana, E. Montoneri, V. Boffa, "Sensitizing effect of bio-based chemicals from urban wastes on the photodegradation of azo-dyes", *J. Photoch. Photobio. A*, **2010**, 209, 224-231.
- [3] A. Bianco Prevot, P. Avetta, D. Fabbri, E. Laurenti, T. Marchis, D. G. Perrone, E. Montoneri, V. Boffa, "Waste derived bio-organic substances for light induced generation of reactive oxygenated species", *ChemSusChem*, **2011**, 4, 85-90.
- [4] A. Amine-Khodja, O. Trubetskaya, O. Trubetskoj, L. Cavani, C. Ciavatta, G. Guyot, C. Richard, "Humic-like Substances Extracted from Composts can promote the Photodegradation of Irgarol 1051 in Solar Light", *Chemosphere*, **2006**, 62, 1021-1027.
- [5] E. Montoneri, V. Boffa, P. Savarino, F. Tambone, F. Adani, L. Micheletti, C. Gianotti, R. Chiono, "Use of biosurfactants from urban wastes compost in textile dyeing and soil remediation", *Waste. Manage.*, **2009**, 29, 383-389.
- [6] www.biochemenergy.it
- [7] E. Montoneri, V. Boffa, P. Savarino, D. Perrone, M. Ghezzi, C. Montoneri, R. Mendichi, "Acid soluble bio-organic substances isolated from urban bio-waste. Chemical composition and properties of products", *Waste. Manage.*, **2011**, 31, 10-17.
- [8] C. S. Uyguner, M. Bekbolet, "Evaluation of Humic Acid Photocatalytic Degradation by UV-Vis and Fluorescence Spectroscopy", *Catal. Today*, **2005**, 101, 267-274.
- [9] R. J. Kieber, X. Zhou, K. Mopper, "Formation of Carbonyl Compounds from UV-Induced Photodegradation of Humic Substances in Natural Waters: Fate of Riverine Carbon in the Sea", *Limnology and Oceanography*, **1990**, 35, 1503-1515.
- [10] F. L. Palmer, B. R. Eggins, H. M. Coleman, "The Effect of Operational Parameters on the Photocatalytic Degradation of Humic Acid", *J. Photoch. Photobio. A*, **2002**, 148, 137-143.
- [11] J. [Theurich](#), D.W. [Bahnemann](#), R. [Vogel](#), F.E. [Ehamed](#), G. [Alhakimi](#), I. [Rajab](#), "Photocatalytic degradation of naphthalene and anthracene: GC-MS analysis of the degradation pathway", *Res.Chem. Interm.*, **1997**, 23, 247-274.
- [12] [K.M. Lehto](#), [J.A. Puhakka](#), [H. Lemmetyinen](#), "Photodegradation products of Polycyclic Aromatic Hydrocarbons in water and their amenability to biodegradation", *Polycyclic Aromatic Compounds*, **2003**, 23, 401-416.